

~~CONFIDENTIAL~~

ARMY AIR FORCES HISTORICAL STUDIES: No. 36

RETURN TO
USAF Historical Archives
ASIS(ASHAF-A)
Maxwell AFB, Ala 36112

NINTH AIR FORCE

*April to November
1944*

DO NOT LOAN

UNCLASSIFIED

SCANNED BY ISA

Unclassified

AAF HISTORICAL OFFICE
HEADQUARTERS, ARMY AIR FORCES

0467627

6-2736, AF

STUDIER INST ALABAMA BRANCH FBI, ALABAMA	FROM TO:
--	----------

0467627

[REDACTED]

F O R W O R D

This narrative was prepared by Lt. Col. Robert H. George, who served as historical officer of the Ninth Air Force from the fall of 1943 to the close of 1944 and who was subsequently reassigned to the AF Historical Office. Based largely on materials forwarded from the theater by him and his associates of the Historical Section, Ninth Air Force, the narrative is the result of firsthand experience as well as careful research. Like other studies in the series, it is subject to revision as additional information becomes available.

[REDACTED]

ARMY AIR FORCES HISTORICAL STUDIES: NO. 36

NINTH AIR FORCE, APRIL TO NOVEMBER 1944

of this monograph and the
in which it was written are in
the Central Division, Archives Branch
11 Air Force Base, Alabama.

Prepared by
AAF Historical Office
Headquarters, Army Air Forces
October 1945

[REDACTED]



C O N T E N T S

I THE NINTH AIR FORCE PLAN FOR INVASION OPERATIONS . . . 1

II PREPARING FOR THE INVASION OF EUROPE 30

III OPERATIONS 6 TO 30 JUNE 1944 61

IV OPERATIONS IN JULY 1944 116

V OPERATIONS IN AUGUST 1944 159

VI OPERATIONS IN SEPTEMBER 1944 232

VII A NEW INTERDICTION PROGRAM, SEPTEMBER TO
NOVEMBER 1944 256

VIII OPERATIONS IN OCTOBER AND NOVEMBER 1944 288

GLOSSARY 322

NOTES 323

BIBLIOGRAPHICAL NOTE 333

APPENDICES 337

INDEX 361



LIST OF APPENDIXES

[REDACTED]

1. Ninth Air Force Tactical Commands, 1 June 1944, 30 November 1944	337
2. IX Tactical Air Command, 1 June 1944, 30 November 1944	338
3. XIX Tactical Air Command, 1 June 1944, 30 November 1944	339
4. XXIX Tactical Air Command (Prov), 30 November 1944; IX Troop Carrier Command, 1 June 1944	340
5. IX Bomber Command 1 June 44; 9th Bombardment Division, 30 November 1944	341
6. IX Fighter Command (cover for D-day)	342
7. Ninth Air Force Tactical Groups	343
8. Ninth Air Force Continental Airfields Used by Tactical Units, June to November 1944	345
9. Ninth Air Force Tactical Installations in Britain, 1 June 1944	347
10. Ninth Air Force Tactical Installations on the Continent, 1 July 1944	348
11. Ninth Air Force Tactical Installations in France, 30 October 1944	349
12. Ninth Air Force Tactical Units, 30 November 1944	350
13. Ninth Air Force Operational Statistics, March to November 1944	351
14. Ninth Air Force Bombing Effort by Type Target, June through December 1944	353
15. Ninth Air Force Cumulative Claims and Losses, All Types Aircraft, 16 October 1943 through 31 December 1944	354

[REDACTED]

[REDACTED]

16. Ninth Air Force Operational Days Classified by Percent of Effective Strength Utilized, 6 June to 13 September 1944	355
17. Ninth Air Force Operational Days Classified by Percent of Effective Strength Utilized, 14 September to 22 December 1944	356
18. IX Troop Carrier Command Routes	357
19. Seine Road and Railroad Bridges	358
20. Ninth Air Force Interdiction, June to August 1944	359
21. The Battle Area, June to August 1944	360

[REDACTED]

Ninth Air Force, April to November 1944

[REDACTED]

[REDACTED]

Chapter I

THE NINTH AIR FORCE PLAN FOR INVASION OPERATIONS

When reconstituted in the ETO under the command of Maj. Gen. Lewis H. Brereton on 16 October 1943, the Ninth Air Force was designed to serve as the American Tactical Air Force which would cooperate with the ground forces in the Allied invasion of Europe. Its organization, its rapid build-up, its training, and many of its operations were all undertaken with this supreme purpose in view.¹

From the very moment of its reconstitution the Ninth Air Force took measures which, more fully developed in the period from December 1943 to April 1944, allowed it to play a major role in the work of producing the plan for its ultimate employment--"The Ninth Air Force Plan for Operation 'Neptune'--Tactical Air Plan."

Planning Procedures

Initiation of Planning Activities

On 3 November 1943 Headquarters, European Theater of Operations outlined the responsibilities of U. S. forces for continental operations planning. This made the Commanding General, First U. S. Army Group responsible for all plans, both operational and administrative, involving operations to or on the continent of Europe by U. S. Army forces, other than air, concentrated in the United Kingdom. The Commanding General, U. S. Army Air Forces in the United Kingdom was charged with

[REDACTED]

[REDACTED]

the necessary coordination of air plans with First U. S. Army Group. Since the Ninth Air Force had previously been designated as the air unit which would furnish tactical air effort in association with the ground forces involved, planning responsibility for its operations was passed on to its headquarters.

Earlier, on 16 October 1943, a Ninth Air Force Deputy Chief of Staff, Plans had been announced. To assist his office in the discharge of its functions, planning sections were thereafter set up in the several staff sections of headquarters.

Coordination with Other Headquarters

On 15 December 1943, concurrently with other Allied unilateral and higher headquarters, the Ninth Air Force established a planning staff in London. These planners who were ordered to London for duty were headed by officers whose previous service (April-August 1943) with Headquarters, COSSAC provided them with continental invasion planning experience. They were drawn from the special and staff sections of Ninth Air Force. Their presence in London assured close contact and full cooperation with the planners of 21st Army Group (British), First U. S. Army Group, First U. S. Army, Services of Supply, European Theater of Operations, Allied Naval Expeditionary Force, U. S. Naval Forces in Europe, Allied Expeditionary Air Force, and 2d Tactical Air Force RAF.

COSSAC Appreciation of Operation Overlord, 15 July 1943, which had been approved by the Combined Chiefs of Staff at the Quebec Conference in August 1943, served as the basic planning document for

[REDACTED]

all forces involved.

Planning Time Table

Upon receipt of directives to proceed with detailed planning, the following time table was established:

- | | |
|---------------|---|
| 30 Jan. 44 | ANXF, 21st Army Group, and AEMAF to prepare Initial Joint Plan |
| 31 Jan. 44 | Initial Joint Plan to be issued |
| 1 Feb. 44 | Planning on Army level to start on basis of Initial Joint Plan |
| 15 Feb. 44 | Joint Plans and estimates on Army level to be submitted to Joint Commanders in Chief as required in Joint Planning Directive |
| 15-28 Feb. 44 | Joint Commanders in Chief to review plans and estimates and order modifications, if necessary |
| 29 Feb. 44 | Army Group to issue firm shipping and craft allotments, showing block priorities each day, and to issue Provisional Build-Up Table of Army Group units (other than those allotted to armies) and air force units (other than those forming part of composite groups). Operation and administration instructions to be issued at the same time, jointly with ANXF and AEMAF where necessary. |
| 1 Mar. 44 | Final planning to start on corps and divisional level |
| 31 Mar. 44 | Final Loading and Build-Up Priority Tables to be forwarded to War Office. |

A delay in this schedule was caused by deviation from COSSAC Plan as ordered by the Commander in Chief, 21st Army Group at the time of his appointment.

Planning Syndicates

Before even the Initial Joint Plan, the first item listed in the time table, could be accomplished, planning was required in much greater detail than the Initial Joint Plan would exhibit. To deal with this detail it was decided to form planning syndicates from which

staff studies would emerge. Upon such staff studies the Initial Joint Plan and operations and administrative instructions would be based.

Accordingly, the Ninth Air Force Planning Group furnished personnel to participate in the work of numerous syndicates whose activities were of interest to Ninth Air Force Headquarters. Meetings of the syndicates were frequent, averaging eight per day. As planning progressed, specialists from IX Engineer Command, IX Fighter Command, IX Bomber Command, IX Air Force Service Command, IX Air Defense Command, and IX Troop Carrier Command were often called to attend the meetings. Their presence served a two-fold purpose--first, it gave the planners first-hand information from those who would perform the missions; and second, it enabled the several commands of the Ninth Air Force to keep abreast of planning progress.

The subjects covered by the planning syndicates were numerous, including the following:

- Provisional Organization of Naval Forces
- Beach Appreciation (Western, i.e., U. S. Sector)
- Outline Mounting Plan (including Briefing)
- Maintenance Appreciation
- Weather
- Air Order of Battle (U. S.)
- Joint Fire Support Plan
- Security
- Airfields
- Employment of Airborne Troops
- Artillery Policy
- Anti Aircraft Artillery Policy
- Intercommunication
- Maps and Models
- Training and Rehearsals
- Plan for Strategic Delay of Enemy Reserves
- Overall Air Plan
- Army Group Build-Up Table
- Organization and Control of Build-Up

[REDACTED]

The papers produced by the Planning Syndicate constituted the technical framework for all plans, whether Army, Air Force, or Navy. This method of planning concurrently with higher headquarters possessed great advantages. In particular it led to the inclusion of those policies and principles peculiar to a tactical air force in the directives and plans of those headquarters. Without such concurrent planning, such policies and principles would have been either omitted from such documents entirely, or included only with extreme difficulty after the documents had been issued by superior headquarters.

Development of Signal Communications Annex

The further development of the Ninth Air Force Tactical Air Plan is well exemplified by the manner in which the Signal Communication annex was developed. As suggested above, an officer of Signal Communication Section was designated as Signal Communication Officer, Plans, and assigned to the Ninth Air Force Planning Group at the time when Signal planning was initiated on 17 December 1943. Much of his work was done at Headquarters 21st Army Group (British) in close collaboration with the 2d Tactical Air Force PAF.

When on 1 February 1944 the general outline of Operation NEPTUNE was laid down by the Initial Joint Plan issued by Headquarters 21st Army Group, work on the detailed Ninth Air Force Signal Plan was begun by a full-time Signal Plans staff. Eight officers comprised the Signal Planning Sub-section appointed on 1 February:

[REDACTED]

1 lieutenant colonel	Assistant communications officer, Plans
1 lieutenant colonel	Wire
1 major	Wire
1 captain	Signal security
1 captain	Radar
1 1st lieutenant	Radio
1 squadron leader	Radar and radio (RAF liaison)
1 captain	Wire (air formation signals liaison)

To assure coordination with other interested Ninth Air Force staff sections, Signal Plans Section maintained and distributed to them a detailed journal of its activities throughout the period 1 February-6 June 1944.

Further to provide necessary coordination the closest liaison was maintained with 2d Tactical Air Force RAF, with 21st Army Group, First U. S. Army Group, and First U. S. Army. Much of this coordination was effected through regularly established committees and boards on each of which the Ninth Air Force Signal Communication Section was represented. A list of such organizations, together with a brief indication of their (1) composition and (2) functions, follows:

Combined Signal Board, Supreme Allied Command

- (1) Chief Signal officers of all services participating in Operation NEPTUNE
- (2) Recommendations of policies, particularly those affecting both British and American services
Allocation of radio frequencies and cable circuits

Joint Signal Board, 21st Army Group

- (1) Signal officers representing all headquarters on the operational level of 21st Army Group, or immediately below
- (2) Recommendations of policies involving the headquarters represented for the period prior to the arrival of Supreme Headquarters Allied Expeditionary Force on the continent
Radio and radar siting, radio frequency, cable circuit allocations, and air-ground cooperation procedures.

Signal Coordination Board

- (1) Signal officers representing all air force headquarters down to and including Ninth Air Force commands and RAF groups
- (2) Coordination of all aspects of Signal planning
Interchange of units and equipment between the Ninth Air Force and the RAF when required

Land Line Committee, Allied Expeditionary Air Force

- (1) Signal representatives of all headquarters under AEAFF
- (2) All problems of wire communications in the United Kingdom, both in preparation for the operation and during its course

Wire Committee, First U. S. Army Group

- (1) Signal representatives of all headquarters in the American sector of the operation
- (2) Coordination of planning for land line communications in the American sector on the continent

Mutual Interference Sub-Committee, Combined Signal Board, Supreme Allied Command

- (2) Study of all types of interference between radio and radar equipments planned
Recommendations to minimize this interference

Radar and VHF Siting Sub-committee, Joint Signal Board, 21st Army Group

- (2) Clearance of all sites on the continent to be used before the arrival there of Supreme Headquarters Allied Expeditionary Force

To further the development of the final Signal Plan an outline plan was early begun. In this, decisions arrived at in the course of planning were included for future reference on the use of Signal units and the provisions for radio and wire communications, fighter control, radar, and security systems. Where applicable these outline plans were sent to interested commands of the Ninth Air Force to serve them as a guide in their detailed planning for the operation.

As planning progressed, several exercises were carried out to determine the feasibility of various parts of the plan. During these

[REDACTED]

exercises all communications--ship-to-shore, point-to-point, and ground-to-air--were thoroughly tested and the plan modified from time to time on the basis of results obtained. By no means incidentally, such exercises provided a dress rehearsal for the units scheduled to participate in the forthcoming operations.

By such means, and on the basis of materials thus provided, the outline plan itself grew, and from it was developed the final Signal Plan which was published on 20 April 1944 as Annex 5 to the Ninth Air Force Tactical Air Plan. Like other portions of that plan it was subsequently amended as required by late changes in the over-all plan and in the tactical plan itself. Even after 6 June 1944, a skeleton plan staff continued to deal with minor changes and to clarify parts of the plan as the time came for them to be carried into execution.

Build-Up Priority Table

Signal planning was of necessity both vital and complicated. But by far the most formidable task of the Ninth Air Force planners was the composition of the Troop List or Build-up Priority Table. So far as the assault lift was concerned this was prepared in conjunction with First U. S. Army, and in respect to the build-up after D plus 15, in collaboration with the First U. S. Army Group. This list showed by tides, by days, and by beaches the planned movements to the far shore of Ninth Air Force units and echelons of units from first tide on D-day through D plus 14. Thereafter units were merely assigned their Army List Index and Unit Serial numbers.

[REDACTED]

[REDACTED]

That this portion of the planning task should be formidable was occasioned by the fact that a tactical air force must not merely fight intensive air battles in the early stages of the operation from bases previously established, but must move its headquarters as the Army moved, and as soon as possible base its aircraft on airfields directly behind the Army's front lines. Not merely aircraft and their crews, but engineers, ground crews, spare parts, and servicing equipment must be placed in the proper place at the proper time and in the desired sequence. Furthermore, in contrast to the movement of nicely packaged ground force elements, the Ninth Air Force must move its units to the continent in "unpacked" lots. The correct phasing of men and materiel to conform with the mission assigned and with the tonnage allocated was the all-important mission assigned to Ninth Air Force administrative representatives. These officers had the grave responsibility of selecting the bits and pieces which, when finally brought together on the far shore, would constitute a working ground organization for the Ninth Air Force.

Briefing and Records

As part of its planning work the staff of Plans Section briefed the Commanding General, Ninth Air Force each day and obtained from him outstanding policy decisions. A Planning Journal, reflecting in some detail the current problems confronted, was also maintained and distributed to the Commanding General; to the Deputy Chief of Staff, Operations; to the Assistant Chief of Staff, A-4; and to the Commanding General, IX Air Force Service Command.

[REDACTED]

[REDACTED]

In the planning phase of other annexes to the Ninth Air Force Tactical Air Plan, close cooperation with interested organizations was also maintained. IX Troop Carrier Command, for example, had liaison officers at AEAFF, Headquarters Ninth Air Force, and at Headquarters 82d U. S., 101st U. S., and 1st British Airborne Divisions; while liaison officers were present at its headquarters from AEAFF (Navigation RGN), 82d and 101st U. S. Airborne Divisions, Headquarters 21st Army Group Airborne Troops, and from the Royal Navy Fleet Air Arm. IX Fighter Command worked intimately with 11 Group RAF in developing "11 Group and IX Fighter Command Joint Air Plan and Executive Order," a document supplementary to IX Tactical Air Command's annex.

The Ninth Air Force Plans Section also maintained the commanding general's map room. Here graphic displays detailed the up-to-date development of the invasion plan, with emphasis on the role of the air forces. Targets were outlined and classified as to time and type of attack. The airfield program was similarly presented. Initial points of assault were shown, Army boundaries indicated, the predicted phase lines of the Army's advance delineated, and the disposition, composition, and strength of attacking and defending forces shown.

To care for the mass of highly classified material a Top Secret Control Section was set up in headquarters under the supervision of the Plans Section. It not merely watched over and registered materials, but was charged with the duplication of all plans in the large-sized reproduction establishment at its disposal. Not one document was

[REDACTED]

lost during the entire period of the plan's preparation.

By virtue of their participation in higher-level planning, the planning agencies of the Ninth Air Force and its subordinate commands became so familiar with antecedent higher directives that publication of the Ninth Air Force Tactical Air Plan was greatly facilitated.

Publication

On 26 April 1944 the Ninth Air Force Tactical Air Plan for Operation NEPTUNE was published, exactly 10 days after receipt of the formal AEAFF directive. Inevitable modifications in the form of amendments were published between that date and D-day. Covering both sides of over 1,300 pages of legal size paper, and containing more than 100 maps and charts, it constituted the battle plan for the largest tactical air force ever to operate as a unit. The whole plan had been coordinated, composed, and checked by Ninth Air Force Plans Section.²

Analysis of the Tactical Air Plan and its Annexes

The "Ninth Air Force Plan for Operation 'Neptune'--Tactical Air Plan" was of necessity a comprehensive document. It contained five main sections entitled Situation, Mission, Operations, Administration, and Command and Control and was furnished with 16 annexes whose significance is self-evident: (1) Intelligence, (2) Build-up Priority Tables, (3) References, (4) Public Relations, (5) Signal, (6) Weather, (7) Chemical, (8) Provost Marshal, (9) IX Tactical Air Command, (10) XIX Tactical Air Command, (11) IX Bomber Command, (12) IX Troop Carrier Command, (13) IX Engineer Command, (14) IX Air Defense Command, (15) IX

[REDACTED]

Air Force Service Command, (16) Movement Liaison Organization.

Mission

The mission of the Ninth Air Force was described as "to assist the Allied Armies to secure a lodgment on the Continent in the first phase of the operation and to support the armies of the First U. S. Army Group in the development of that lodgment in the second phase."

Aims and Commitments

The aims and commitments of the Ninth Air Force for the assault phase of the operation and in later phases through 18 June 1944 are given below. It is to be observed that in the various sections of the Tactical Air Plan reference is frequently made to tasks assigned in the preliminary phase (to approximately D-30), and in the preparatory phase (D-30 to D-1). Since the Plan only lists these assignments in general terms, and since they merely recapitulate the main objectives of the preparatory operations which will be narrated later, they will not be rehearsed here.

IX Tactical Air Command

IX Tactical Air Command was given operational control of XIX Tactical Air Command units until such time as the Third U. S. Army commenced offensive operations on the continent. At that time XIX Tactical Air Command was to revert to normal control and command. On the other hand IX Tactical Air Command was to operate under the direction of IX Fighter Command through the Combined Control Center (IX Fighter Command and 11 Group RAF) at Uxbridge until such time as

[REDACTED]



IX Tactical Air Command should be established on the far shore.

Its definite tasks and commitments follow. In connection with them it should be noted that many details and all figures are those which appear in the "11 Group and IX Fighter Command Joint Air Plan and Executive Order," 25 May 1944, as amended 1 June 1944. The figures involve slight modifications of those given in the earlier Tactical Air Plan and its Annex No. 9.

High cover over assault beach area (day)	5 groups
Shipping cover (day)	2 groups
Air cooperation (against pre-arranged targets)	6 groups
Reserve (pool of readiness)	<u>5 groups</u>
Total	18 groups

All fighter-bomber groups were to be prepared to operate on a scale of four group sorties per day.

High beach cover. Low cover (3,000 to 5,000 feet or below clouds) over the assault beach area was a British commitment. High cover by American P-47's was to be flown at heights between 8,000 and 15,000 feet or below clouds of 10/10ths. They were to endeavor at all times to keep the low-cover patrols in visual contact. High cover was to be maintained at all times during the day by three squadrons which remained for one hour over the assault beach area. That area was defined as extending five miles inland from the beaches and 15 miles to seaward of them for each of the two squadrons assigned to cover the American and British beach areas respectively, and eight to 10 miles inland and five miles to seaward for the squadron assigned to high cover in the central area.



Shipping Route Cover. P-38's had been chosen to afford cover over the main shipping route and its flanks because the relative ease of their identification would afford a guarantee against friendly fire. Two Ninth Air Force groups together with four groups from VIII Fighter Command were assigned to this task. Patrols of four-squadron strength were to maintain continuous cover, beginning at 1600 hours on D minus 1, and to operate at heights of from 3,000 to 5,000 feet or below clouds. Each patrol was scheduled to be over the shipping area for 90 minutes. The routes followed by patrols proceeding to and from the beaches gave added protection to the main shipping route.

Air Alert Squadrons. On D-day, during the initial assault period, one squadron was to patrol each beach under the control of the appropriate headquarters ship. These squadrons were to attack defense targets which the main bombing operations had not neutralized, and which were seen from the air to be interfering with the actual landing of our forward troops. If no targets presented themselves by the end of the prescribed period of the patrol, predetermined targets were to be attacked.

Escort. IX Tactical Air Command was further to furnish close escort to IX Troop Carrier operations by day, and to make available one tactical reconnaissance group for use in conjunction with ground forces on the scale of three group sorties per day.

General Commitments. The combat assignments detailed above, plus such as might be directed on the part of the groups committed to air

[REDACTED]

cooperation and those ready to operate in the air at shortest notice from reserve were to be determined in accordance with the Joint Air Force's tasks of (1) protecting the cross-Channel movement against air attack, (2) preparing the way for the assault by neutralizing coast and beach defenses, (3) protecting the beaches from air attack, (4) reducing the enemy's ability to mount effective counter attacks, and (5) providing full air-ground cooperation in the advance of the ground forces from the assault beach head.

Assignment of Personnel. Other duties were assigned to units or personnel of IX Tactical Air Command. Its Air Representatives were to be detailed to the headquarters ships and the Controllers to fighter direction tenders. Its 70th Wing was to move early to the far shore there to operate a fighter control station for the First U. S. Army area and to supervise all Ninth Air Force units until the arrival of Advanced Headquarters IX Tactical Air Command. With it rested responsibility for the operation of refueling and rearmament strips and advanced landing grounds as they became available, for aircraft warning, and for the air defense of the American sector by day and by night. Night defense was to be afforded by operational units furnished by 85 Group RAF.

Association with First U. S. Army. Headquarters and Headquarters Squadron IX Tactical Air Command was to establish an advanced headquarters adjacent to Advanced Headquarters First U. S. Army on the far shore and to remain with it during subsequent moves. This was planned

[REDACTED]

[REDACTED]

to render more effective their air-ground cooperation. In similar fashion the air-ground coordination of XIX Tactical Air Command and the Third U. S. Army in the second phase of operations was to be fostered by the physical association of their headquarters on the continent. Such actions merely continued the liaison and the execution of necessary details incidental to joint operations established and maintained by the associated armies and tactical air commands while based in the United Kingdom.

IX Bomber Command

Types of Targets. In the assault and later phases of operations, IX Bomber Command was to operate its units from airfields in the United Kingdom. On D-day the bulk of its 11 groups was to be utilized in bombardment of beach defenses at the earliest time visibility permitted. The balance was to be employed to support fighter-bombers in attacks on coastal installations. Subsequent to D-day its forces were to be used in attacks against enemy concentration areas, reserve areas, communication centers, MT concentrations, command and control centers, and in battle-area air attack when required.

Direction of Activities. The operations of IX Bomber Command units were to be directed in the following manner:

1. Targets to be attacked, and strengths and timing of attacks by operational orders from Advanced Headquarters Ninth Air Force to Headquarters IX Bomber Command
 2. Routes to and from targets, bomb loads and fuzing, and communications procedures by field orders from Headquarters IX Bomber Command to combat wings
- [REDACTED]

3. Initial points, load, groups and boxes, and other necessary supplemental information by orders from combat wing headquarters to bombardment groups.

It was planned that Advanced Headquarters Ninth Air Force should precede IX Bomber Command units to the continent and there control all operations of that command.

IX Troop Carrier Command

IX Troop Carrier Command's plan envisaged the full employment of its large resources. These consisted of 14 troop carrier groups under three wings, and comprised 56 squadrons of C-47 and C-53 aircraft (totaling 1,022 aircraft and crews). In addition it had available 1,352 glider pilots (plus 445 co-pilots), 2,000 Waco gliders (CG-4A's), 360 Horsa gliders (British), and 200 additional Horsa gliders for a possible mission with the 1st British Airborne Division.

Assault and Later Phases. In the assault phase it was planned that IX Troop Carrier Command should lift parachute troops and glider-borne troops of the 82d and 101st U. S. Airborne Divisions from staging areas in England to drop and landing zones on the continent, there to assist the Allied armies in securing a bridgehead. In the assault and subsequent phases the command was to resupply the ground forces by air as required, to evacuate casualties, and to be prepared to lift one British airborne division to drop and landing zones behind enemy lines in the assault area. So long as the situation required, IX Troop Carrier Command was to function under the operational control of the Supreme Commander, Allied Expeditionary Forces.

10th Photo Reconnaissance Group

The 10th Photo Reconnaissance Group was assigned to perform day and night tactical and semi-strategic photo reconnaissance missions as ordered by Advanced Headquarters Ninth Air Force during the assault and later phases of the operation, and to execute bomb-damage-assessment photography for IX Bomber Command. Its operations were to be based on the United Kingdom during the assault phase and for some time thereafter. During the assault it was estimated that the group could execute three group sorties per day.

IX Engineer Command

Airfield Construction. IX Engineer Command commitments were both vital and varied. It was planned that its initial detachments should land with the assault waves on Omaha and Utah beaches on first tide of D-day. These and subsequent units were to provide parties for the reconnaissance of advanced landing grounds and personnel for the initial layout and construction of one emergency landing strip behind each beach. The schedule for the construction of other ground facilities in the period between D-day and D plus 14 was as follows:

Beach Omaha

<u>Type of field</u>	<u>Location</u>	<u>Construction to start</u>	<u>Field to be operational</u>
ELS	Northwest of Vierville sur Mer	D	D plus 1 a.m.
*RAS	St. Pierre du Mont	D plus 1 p.m.	D plus 3 p.m. (untracked) D plus 4 p.m. (tracked)
*RRS	South of Criqueville	D plus 1 p.m.	D plus 3 p.m. (untracked) D plus 4 p.m. (tracked)

Type of field	Location	Construction to start	Field to be operational
**ALG	St. Pierre du Mont		D plus 8 a.m.
ALG	Criqueville		D plus 8 a.m.
**ALG	Cardonville	D plus 3 a.m.	D plus 7 a.m.
ALG	Deux Jumeaux	D plus 4 p.m.	D plus 8 a.m.
ALG	Hestry	D plus 9 p.m.	D plus 14 a.m.

Alternates: Poix, La Campe, Colleville.

Beach Utah

ELS	Ste. Mere Eglise	D	D plus 1 a.m.
ALG	West of Beuzeville	D plus 1	D plus 8 a.m.
ALG	North of Azeville	D plus 6	D plus 10 a.m.
ALG	Garentan	D plus 10	D plus 14 a.m.

Alternates: Picaucville, south of Valognes.

Such ground facilities were rated as essential to the Ninth Air Force in the performance of its tactical mission.

Other Commitments. The improvement and maintenance of roads to advanced landing grounds and other Ninth Air Force installations (exclusive of those in the communications zone), and the construction and repair of buildings for headquarters camps or sites as ordered figured as additional IX Engineer Command assignments. It was further to afford technical assistance in camouflage operations, to inspect camouflage security measures, and in special cases to execute camouflage projects. The enforcement of camouflage discipline was another responsibility of this command. It was also charged with the establishment of water points to serve Ninth Air Force units and with the

- * St. Pierre du Mont and Criqueville were to be constructed initially as refueling and rearming strips to become operational as soon as a runway could be graded and compacted. The runways were then to be paved with square-mesh landing mat and the fields developed into complete advance landing grounds by D plus 8 a.m.
- ** Cardonville, Deux Jumeaux, and Beuzeville were to be developed as rapidly as possible to 5,000-foot paved runways suitable for the operation of fighter-bombers.

[REDACTED]

operation of the same until the arrival of service groups or teams of IX Air Force Service Command. It was likewise responsible for the supply of standard maps, the preparation of special maps and charts, and the reproduction of other work required by Ninth Air Force units. Engineer supply, however, was a responsibility of IX Air Force Service Command.

IX Air Defense Command

In the period covered by this report the IX Air Defense Command was to continue its earlier functions of supervising and allocating all antiaircraft units assigned or attached to the Ninth Air Force, and to supervise all airdrome defense activities within it. It was to make air-raid intelligence available to passive air defense control centers and to coordinate and perform such aircraft movement liaison functions as were made the responsibility of the Commanding General, Ninth Air Force. Later it was to be charged with the operation and control of night fighters in the American sector with the assistance of 85 Group RAF and was to relieve IX and XIX Tactical Air Commands, as they displaced forward, of responsibility for daylight interception of enemy air attacks and for air warning services.

"The general Air Defense Plan is to establish as rapidly as possible behind the advancing armies an adequate and effective coordinated air defense of vital installations. Initially the defense will consist of ground-controlled day and night fighters and of operationally-controlled antiaircraft units. The defense will

[REDACTED]

ultimately be supplemented by the establishment of fighter searchlight belts as required."

IX Air Force Service Command

Under the Ninth Air Force Tactical Air Plan, IX Air Force Service Command was responsible for direct supply and services to all Ninth Air Force units as that command was progressively built up on the continent.

Preparation for D-day. Prior to the invasion, however, it was to store and prepare for shipment the supplies and equipment necessary for the operation of Ninth Air Force units across the Channel, consolidate and assure the procurement of their requirements for common supplies, and coordinate the procurement of their shortages in unit equipment and air force supplies.

It was to prestock airfields in the United Kingdom to assure that, in view of road congestion inevitable from approximately D minus 15 to D plus 15, units should operate at full efficiency in air operations based on Britain and still be able to move to the continent with their full T/E. Ninety thousand gallons of aviation POL were ordered prestocked on each ALG, and also a total of 20,000 tons of ammunition and bombs stocked for all fighter ALG's, together with 30,000 tons of the same for fighter-bomber ALG's.

"Ten Day" pack-up kits were to be prepared for the use of air-drome squadrons prior to the arrival of fighter squadrons on airfields in France, and Mareng cells for the storage of gasoline there were to

[REDACTED]

[REDACTED]

be issued to units prior to their departure from home stations.

Transportation, Equipment, and Personnel. As units moved to the marshalling areas IX Air Force Service Command was to furnish the necessary transportation to supplement their organic transportation. Always it had in charge the main reserve of equipment and of personnel, together with major repair facilities which were not to be transferred to the continent.

Responsibilities on the Continent. In the assault phase, IX Air Force Service Command was directed to furnish an air force beach party to identify, segregate, and store all air force technical supplies, except class III-A. Through liaison with the British it was to identify and route such supplies and equipment as might have been erroneously landed over British beaches. It was further to establish and operate air force beach dumps for air force classes II and IV-D, Engineer construction materials, and class V-A supplies, and to furnish the transportation necessary to move all air force supplies to airfield locations.

These functions were to be intensified and enlarged in subsequent phases of the operation. Among commitments of note for the period under review were the provision of equipment and supplies for combat units of the Ninth Air Force as they should arrive on the far shore. Tactical air depots were to be stripped of heavy repair machinery and moved to the continent as soon as deemed necessary. The Transportation Division of the command was made responsible for the operation of

[REDACTED]

[REDACTED]

routine air transportation, for supply by air of air force supplies from the United Kingdom to the continent, and for the early establishment (approximately D plus 4/D plus 5) of an Air Dispatch Letter Service between the new advanced landing grounds on the far shore and the United Kingdom.

Replacement aircraft were to be delivered to the continent from replacement pools at Chilbolton and Membury, and field artillery liaison aircraft similarly delivered from a pool at Grove. Quartermaster Truck Regiment Headquarters and a vehicle park were to be established in Omaha beach area to provide supplementary transportation for units of the Ninth Air Force ashore.

IX Air Force Service Command planned to supervise the discharge of these significant functions through an advanced headquarters (including personnel from 2d Advanced Air Depot Area) whose first echelon was scheduled to land on D plus 2.

Signal Communications

The Signal Communications mission as set forth in Annex 5 to the Tactical Air Plan was expressed in general and simple terms: ". . . to plan and provide signal communications for the Ninth Air Force during the mounting of the Operation in the United Kingdom, the pre-assault phase, the assault phase and the subsequent build-up phase on the continent."

The details of the Signal Plan were, however, infinite, and the importance of signal communications for the success of air operations was so great that a summary of the major details of the Signal Plan are given here.

Mounting Phase. In the first, or mounting phase, when all Ninth Air Force units were in the United Kingdom, wire, radio, and messenger

[REDACTED]

[REDACTED]

communications were to be provided between Headquarters Ninth Air Force and its commands and units. Similar links were to be established between Headquarters Ninth Air Force, its subordinate commands, and the headquarters of higher formations and others associated with the Ninth Air Force in the impending operation. Furthermore, IX and XIX Tactical Air Commands, IX Bomber Command, and XIX Troop Carrier Command required signal communications, radio navigational aids, and aircraft warning to enable them to perform their NEPTUNE missions while still based in the United Kingdom. These were to be provided, at times in cooperation with the PAF; e.g., a fighter control station (MEW) of IX Tactical Air Command was to augment the fighter direction facilities of Air Defense of Great Britain RAF, while Controllers and Signal personnel were to be provided the ADGB operations room and sector operations rooms which were to direct Ninth Air Force aircraft. As Ninth Air Force units began their movements toward the far shore, communications between its headquarters and the concentration and marshalling areas involved were to be supplied.

Pre-assault Phase. In the second, or pre-assault phase, when certain headquarters and units of the Ninth Air Force were afloat, an increase of communications was required. They were to be established between designated command posts in the United Kingdom, Ninth Air Force Headquarters, and units afloat. Where necessary, radio air-to-ship communications between aircraft of the Ninth Air Force and designated ships were to be provided.

[REDACTED]

[REDACTED]

In this connection, communications were especially necessary between Ninth Air Force Headquarters at Uxbridge and flagships and fighter direction tenders in the Channel. Ninth Air Force representatives were to be present on board U.S.S. Augusta (Western Naval Force and First U. S. Army flagship), U.S.S. Ancon (Omaha assault force flagship, V U. S. Corps and 1st U. S. Division), U.S.S. Bayfield (Utah assault force flagship, VII U.S. Corps and 4th U. S. Division), and U.S.S. Henrico (relief to U.S.S. Ancon and U.S.S. Bayfield). Theirs was a vital role in connection with air-ground cooperation, i.e., the offensive use of Ninth Air Force aircraft.

To enable them to discharge their functions effectively various sources of information were provided. (1) Air Command broadcast channel for the special use of the Allied Expeditionary Air Force at Uxbridge. In emergency, the flagship, headquarters ships, and fighter direction tenders might transmit on this frequency. (2) Ninth Air Force command channel from Uxbridge. This was later to be extended to Advanced Headquarters IX Tactical Air Command. (3) Three Air Support channels between Uxbridge, the ships, and the far shore. The Task Force flagship maintained a listening watch on all three channels. A transmitter was available at Rear Headquarters First U. S. Army, Plymouth, for the purpose of relay if the Air Support Parties could not work directly to Uxbridge, and if the headquarters ships were for some reason unable to relay. (4) Air Representatives and Controllers liaison between the Combined Control Center (IX Fighter Command and 11 Group RAF) at Uxbridge and those officers with the Western Naval

[REDACTED]

Task Force. It was later to be extended to the Fighter Control Center of IX Tactical Air Command when it was set up on the far shore.

(5) Three VHF channels for communications between headquarters ships and aircraft on offensive missions. The same channels were to be used by fighter direction tenders to direct fighter cover. Communications between headquarters ships and fighter direction tenders were also envisaged, together with communications with Air Support Parties ashore, broadcast reception channels, and Y-Intercept. Navy and Army communications were also to be available.

Assault Phase. In the third, or assault phase, when certain headquarters and units of the Ninth Air Force were established on the continent and others were afloat and in the United Kingdom, an additional increase of facilities was planned. Communications, as earlier established between the United Kingdom and ships, were to be extended to designated units on the far shore, and strengthened. Radio air-to-ground communications between Ninth Air Force units and designated units ashore were required as were aircraft warning and fighter control facilities. All were to be supplied.

Air Support Parties and Air Support Controls were to be provided with signal communications as were ground liaison officers at Ninth Air Force airfields. Wire communications were to be provided between Ninth Air Force units on the beachhead and between Headquarters First U. S. Army Group and Ninth Air Force. Wire communications between 85 Group RAF units in the American and British sectors, and between designated units of the Ninth Air Force and co-equal units

[REDACTED]

of the 2d Tactical Air Force RAF, were to be established in agreement with First U. S. Army, Second British Army, and the 2d Tactical Air Force RAF. Signal radio communications were to be afforded between units of the Ninth Air Force on the far shore, and laterally between such units and designated units of the 2d Tactical Air Force RAF.

Build-Up Phase. In the fourth, or build-up phase on the continent facilities already existing were to be still further expanded so as to provide for the anticipated communications load between Headquarters Ninth Air Force and its commands, for internal traffic between Ninth Air Force units, and for lateral communications between the Ninth Air Force, 2d Tactical Air Force RAF, and their designated units. Further, in agreement with the headquarters concerned, signal radio and wire communications were to be established between Headquarters Ninth Air Force and the headquarters of higher formations on the continent and in the United Kingdom. Specifically, submarine cable communications were to be provided between Headquarters Ninth Air Force on the continent and designated headquarters in Britain over cables laid by others than the Ninth Air Force. It was anticipated that the first of these cables would be laid to a point on the beach near Bayeux by D plus 6.

Messenger Service and ADLS. Certain further points in the Signal Plan are worthy of mention. Messenger service was to be supplied between rear and advanced headquarters and commands of the Ninth Air Force. When some units were afloat this was to be supplemented by a similar service embracing the terminals of the Air Dispatch Letter Service and

[REDACTED]

[REDACTED]

the Naval Dispatch Boat Service. On the far shore IX Tactical Air Command was to maintain such a service to the above terminals, to its own units, and to Headquarters 2d Tactical Air Force PAF. On the continent also Headquarters IX Engineer Command and Advanced Headquarters IX Air Force Service Command were to establish a messenger service on a comparatively reduced scale. It was planned that an Air Dispatch Letter Service should be operational on D plus 3, involving three trips per day from Northolt and Whitchurch to Headquarters IX Tactical Air Command, and eventually to Advanced Headquarters Ninth Air Force, XIX Tactical Air Command, and IX Air Defense Command on the continent.

Other Commitments. The fact that the Eighth Air Force and 2d Tactical Air Force PAF were to share in the forthcoming air operations made it necessary to plan for the provision of air-to-ground and air-to-air communications between certain of their airborne and ground units and those of the Ninth Air Force.

Signal intelligence was provided for by special detachments. Mobile air reporting units and rear area reporting units of the IX and XIX Tactical Air Commands and IX Air Defense Command were furnished means of reporting air warning information to filter and fighter control centers, and were furnished with necessary multiple communications with ground observation posts, forward direction posts, and D/F units.

Since tactical reconnaissance aircraft might, in emergency, be

[REDACTED]

[REDACTED]

employed for artillery spotting at Army request, provision was included for the necessary ground-to-air communication.

To make tactical reconnaissance reports available to First U. S. Army formations with a minimum of delay, such reports were to be broadcast during the assault from the home base of reconnaissance groups for reception by Army units afloat or ashore. When reconnaissance units should begin to operate from ALG's in France a preliminary broadcast was to be made by Advanced Headquarters IX Tactical Air Command and followed by complete reports broadcast from home base in the United Kingdom.

That speed was regarded as an essential in the provision of signal communications is evidenced by two further items. First, three transportable air radio stations were to be activated and, from D-day on, placed at IX Troop Carrier Command stations in a state of readiness to be flown to the beachhead. Second, the Signal Plan included the provision that the Ninth Air Force should assist in the construction of the main-line wire network on the continent and in this connection pool available Signal construction personnel with the zone of communications and/or field force signal construction personnel. The pooled personnel were to operate under the direction of the First U. S. Army Group's Joint Wire Group.

In the preceding paragraphs the Signal Plan has been greatly condensed. From the major details presented, however, it is evident that the Ninth Air Force was committed to provide a great complex of signal communications--no less would suffice a tactical air force of its size when engaged in an operation of such magnitude as NEPTUNE.³

[REDACTED]



Chapter II

PREPARING FOR THE INVASION OF EUROPE

While the Ninth Air Force Tactical Air Plan was being carried through its later stages certain operations were begun directly related to that plan, and final actions were taken to enable the Ninth to accomplish its full mission at the time of the invasion itself. Conspicuous among the final actions were the tactical redeployment of Ninth Air Force units and the elaboration of a substantial mechanism to further air-ground cooperation. The operations were part of what General Eisenhower was later to describe as "The brilliant preparatory work of the air forces, a belief in which was a very cornerstone of the original invasion conception. . . ." ¹

Operations Preparatory to the Invasion

These combat operations had been envisaged in the Tactical Air Plan itself, which provided that "during the preparatory phase the objectives of Allied Air Forces will be the reduction of the German Air Force, the destruction of strategic rail centers, selected enemy coastal defense, Crossbow and Naval installations and airfields in the Neptune area. Strategic and tactical reconnaissance will be intensified." The policy calling for such activities rested upon the sure foundation of Field Service Regulations 100-20.

Attacks on Airfields

Field Service Regulations 100-20 prescribe as first priority for



[REDACTED]

a tactical air force the gaining of "the necessary degree of air superiority," and further declare that "Air superiority is best obtained by the attack on hostile airbases, the destruction of enemy aircraft at rest, and by fighter action in the air." Throughout the period under review destruction of enemy aircraft by fighter action in the air was chiefly accomplished by Ninth Air Force planes' escorting the heavy bombers of the Eighth Air Force over Germany. Attacks on enemy airfields had been a constant feature of independent operations of the Ninth Air Force based in the United Kingdom. They were continued against such targets in Holland, Belgium, and northern France throughout April and May 1944 in the effort to secure and maintain air superiority.

April Missions

During April, when such targets rated as sixth priority for the Ninth Air Force, at least 28 enemy airfields, ranging from the coastal region as far south as Bourges, Orleans, and Rennes, were subjected to a total of over 30 attacks. Of these, all except nine were delivered by fighter-bombers which bombed in over 20 cases, strafed in five others, and followed their bombing attacks by strafing in yet another five instances. Installations servicing the fields were the special objectives. Results were difficult to assess, but pilots' claims were generally "good." In only three instances were there claims of enemy aircraft destroyed on the ground: on 5 April two at Triqueville and six on the two fields at Orleans and Chateaudun, and 11-plus at Thionville on 14 April.

[REDACTED]

[REDACTED]

In April medium bombers delivered a total of nine attacks on six different airfields, none of which had been assigned as primary targets for the missions. Three attacks were made on Chievres by 36, 14, and 18 planes respectively on 11, 12, and 13 April. In the two cases where results were observed, bursts occurred on the landing ground or among buildings. Coxyde/Furnes was also hit three times, on 8 April by 35 planes from two groups and on 10 and 12 April by 13 and 12 planes respectively. The bomb pattern of the 8 April attack blanketed one dispersal area and that of the assault of 10 April covered another. The 12 April attack produced no notable result. The attacks on Cormeilles en Vexin (28 April) and Ostend/Middlekirk (12 April) were not significant; but bursts occurred among buildings in the 12 April attack on Courtrai/Wevelghem, while at Poix (20 April) a heavy concentration of bombs from 28 planes fell in a dispersal area.

May Missions

In the month of May 1944 enemy airfields were given a generally higher priority among Ninth Air Force targets than hitherto. Furthermore, attacks were stepped up in number and weight, and the total number of airfields attacked was increased. The airfield targets for this month lay within, or adjacent to, the eventual area of invasion operations, for it was desired to neutralize all airfields within 130 miles of the assault beaches, or within a strip of territory extending as far south of the French coast as the distance north from it to

[REDACTED]

[REDACTED]

Allied operational bases in the United Kingdom. If this desire were realized, the enemy would be under the same disadvantage as the Allies in operating in the invasion area.

From 1 May through 5 June airfields situated at no less than 36 places, from Brittany well into Holland, were subjected to attacks. At least 26 such fields were assaulted at least once by fighter-bombers which delivered a total of over 30 dive-bombing and 11 strafing attacks. Pilots' reports were more optimistic than in April and usually chronicled results as "excellent" or "good." The number of attacks by medium bombers increased to nearly 40, as fields at 30 different places were attacked at least once each.

In contrast to the April attacks by the mediums, all the attacks of this period had airfields assigned as their primary targets. Nine fields were subjected to particularly frequent or heavy attacks. Evreux/Fauville was hit by one group on 8 May, by two on 20 May, and by two more on 22 May. Dispersal areas, hangars, and a fuel dump were well hit, while concentrations fell on the landing ground. Two groups hit Achiet on 24 May and the same number on 29 May. Again the dispersal area was hit. Damage was also done to the taxi track, and a fuel dump was blanketed by bursts. Beaumont le Roger was struck by one group on 11 and 23 May, by two groups on 22 May, and by three on 24 May. Dispersal areas were heavily struck, and direct hits scored on runways and the perimeter track.

Cormeilles en Vexin was attacked by three groups on 11 and 20 May and by two on 22 May. Here the dispersal areas were struck and

[REDACTED]

[REDACTED]

considerable damage done to buildings. Furthermore, revetments were blanketed and hits were scored on taxi strips and perimeter track. Beauvais/Tille was bombed by one group on 13 May, and by two on 22 and 24 May. Dispersals and hangars were hit hard, craters blown in ammunition and fuel areas, and bursts observed on runway and taxi track. Beaumont sur Oise was attacked by one group on 11 and 24 May and by two on 20 and 26 May. Once more damage appeared to be concentrated in dispersal areas, although the bombs of the attack on 20 May fell on the runways and perimeter track.

Dispersal areas were badly damaged at Abbeville/Bruhat in the attacks by one group on 13 May, by two on 21 May, and by three on 24 May. Dornin/Frouvy was hit by two groups on 20 May and by two on 24 May. Two explosions resulted, buildings were destroyed, and the perimeter track and landing ground damaged. Chartres was attacked by four groups on 26 May and by three on 3 June, with heavy damage done to shelters and buildings in a hangar area and the runway and the landing ground well hit.

Damage done to runways, landing grounds, and taxi strips increased in significance as the invasion date approached, for as D-day drew nearer and nearer the enemy was given less and less time in which to effect repairs. By such means the Ninth Air Force contributed to the establishment of an unquestioned air supremacy for the Allied forces when the invasion began.²

Attacks on Communications Targets

Second priority among the missions assigned to a tactical air

[REDACTED]

[REDACTED]

force by Field Service Regulations 100-20 is "To prevent the movement of hostile troops and supplies into the theater of operations or within the theater." Accordingly communications targets figured prominently among those attacked by the Ninth Air Force long before D-day.

At the start they had to be selected with great care in order that complete security in respect to the invasion plans might be maintained. This necessary safeguard rendered the exact purpose of many actions obscure at the time that they transpired, but as time went on they slipped into their proper places in connection with the general plan preparatory to the invasion. With our present perspective we can see some three special programs for attacks on communications targets as parts of a single Ninth Air Force plan: first, attacks on railway centers, such as marshalling yards, servicing facilities, and locomotive works; second, attacks on rail and road bridges; third, growing out of the first two, a program of rail and road interdiction designed to complete the "isolation of the battlefield" by denying to the enemy food, ammunition, and reinforcements. Of these associated programs the first two were developed and carried into execution well before D-day. The third had perforce to remain under wraps until 6 June 1944.

Railway Centers--Marshalling Yards

Railway centers had appeared as targets in bombardment directives since early February 1944 and had been subjected to frequent attacks by the Ninth Air Force. The AFAP directive of 1 April 1944, however,

[REDACTED]



served to underline their importance. To them it accorded first priority among targets. Furthermore, the first paragraph of the directive contained the significant statement that "The Supreme Allied Commander has decided that the time has now come for the operations of the AEF to be directed more closely towards the preparation for 'Overlord'. . . ." Again, by directive of 1 May 1944, AEF stated that "In order that the greatest possible destruction may be accomplished on the transportation system affecting the future invasion, it is desired that every opportunity for attacking these vital rail centers be utilized." The connection between this program and the planned invasion was obviously immediate, as from 1 April 1944. Accordingly this report will concentrate its attention upon attacks on such targets delivered between 1 April and 6 June 1944, although in some instances earlier actions must be cited.

Attacks 1 March-5 June 1944. In the period between 1 March and D-day 36 marshalling yards were attacked 139 times. The concentration of attacks was as follows:

1	marshalling yard	attacked	11	times
1	"	"	8	"
4	"	yards	7	"
4	"	"	6	"
3	"	"	5	"
3	"	"	4	"
9	"	"	3	"
3	"	"	2	"
8	"	"	1	time

Selection of Targets and Methods of Attack. The targets lay in Belgium and in northern France, and they were assigned in blocks to



[REDACTED]

the end that closely integrated portions of the rail systems in those regions might be knocked out as nearly at the same time as possible, thus producing a maximum effect upon their operation. Major attacks were of necessity delivered by IX Bomber Command aircraft, but the fighter-bombers had their assigned role as well. They not only followed up the mediums' assaults by "tickling" attacks, designed to impede the work of repair, but also delivered independent assaults and further supplemented the work of the mediums by bombing or strafing after they had completed their work of escort to the Marauders. If each mission against such targets were counted as an attack, the total for the months of April and May alone would exceed that given above for the period from 1 March through 6 June 1944. The total of more than 200 missions in April and May was about equally divided between the mediums and the fighter-bombers.

The intensity of the attacks, notably after the appearance of the directive of 1 May 1944, is suggested by the fact that 26 such missions were flown on 1 May, 13 on 3 May, 17 on 10 May, 12 on 11 May, and 11 on 20 May 1944. Thereafter the number decreased markedly because of the accent then placed on the program which had rail and road bridges as its targets.

Results Attained. The results attained were of a very high order, the larger proportion of the attacks warranting the classifications "good" to "excellent." It would be fruitless if not impossible to attempt a consolidation of all reports on such actions. Their general

[REDACTED]

[REDACTED]

effect is, however, well portrayed in the reports of damage done by attacks on characteristic targets.

Creil was the railway center most frequently attacked, being hit no less than 11 times between 7 March and 22 May 1944. The first two attacks on 7 and 17 March destroyed 60 freight cars, damaged 180 more, cut every track at least once, and damaged the engine shed by blast. On 20 March three direct hits were made on the engine workshop; two were scored on a standing train and the through lines cut in eight places. Three days later two locomotive sheds were destroyed and heavy damage inflicted on rolling stock. The attack of 20 April resulted in only insignificant damage, but a week later 10 hits blocked all lines. On 10 May the locomotive depot was reported 70 per cent destroyed and the roundhouse completely demolished, with storage and reception sidings all cut. Attacks of 20 and 24 May put the marshalling yard 60 per cent out of action, destroyed at least 50 freight cars, and further damaged the rails.

At Bethune, which was attacked on eight occasions in the period 30 April to 20 May inclusive, the damage was reported to be equally severe. Thirty freight cars were destroyed and 70 damaged by the attack of 30 April. On the following day essential buildings were destroyed or damaged. The attack of 26 April partially destroyed the locomotive shed and repair shop and inflicted additional damage to buildings, while that of 27 April cratered the sidings, although with little damage to rolling stock. Buildings and facilities were further damaged on 8 May and the main lines to Rouen and to Evreux cut in

[REDACTED]

[REDACTED]

five and three places respectively.

Similar reports, based on strike attack or reconnaissance photographs, were the rule following missions flown against targets at such critical points as Arras, Namur, and Valenciennes; Aulnoye, Mezieres, and Aerschot; Mons, Mantes-Gassicourt, and Busigny. Throughout there was a need for extremely accurate bombing since the rail centers often lay in proximity to built-up areas. This fact caused priorities to be assigned targets of this class which were based on the expected number of civilian casualties. Constant attention given to the improvement of bombing accuracy throughout this period undoubtedly helped to keep the number of gross errors low. The development in May of the practice by the mediums of bombing by flights of six on converging lines of attack played a definite role in assisting improvement which was the more to be desired since "in a short while gross errors [would] mean death for allied soldiers, rather than death for civilians."

It is certain that in many cases repairs to through lines could be effected in a short period of time after an attack on a railway center had been delivered, and that the enemy's skill in employing alternative facilities to those destroyed was great. Nevertheless, the total expenditure of effort for purposes of repair in which he was forced to engage was appreciable, the inconveniences to which he was subjected were distressing to him, and the absolute loss of rolling stock, and particularly of locomotives, one which he could

[REDACTED]

ill afford. Allied air attacks on railway centers were held to have caused the capacity of the railways of the northern half of France, which had previously exceeded by far the enemy's military and economic needs, to fall by D-day below the level with which he had sustained his garrison troops in the preceding period. Together with closely related programs, this of the Ninth Air Force against railway centers assisted in carrying out the mission against communications assigned to it by Field Service Regulations.³

Bridges

Rail Bridges. Closely related to the air attacks on railway centers was a definite program of attacks on rail, and eventually road bridges. This had its inception on 7 May 1944, when, on the initiative of Advanced Headquarters Ninth Air Force, ABEAF agreed that rail bridges on the Seine and the Meuse might be attacked. For the sake of security an equal number over each of the rivers were to be assaulted. Fighter-bombers were to concentrate on two bridges in each area and mediums on one in each, and both were to continue their efforts until the designated targets were destroyed.

That same day fighter-bombers attacked the Seine bridges at Mantes-Gassicourt, Cisseel, Orival, and Vernon. At Vernon eight aircraft completely destroyed the bridge with 16 x 1,000-pound GP bombs in a zero-level attack. On 8 May fighter-bombers sent against a Seine bridge destroyed three of the 11 spans of the railway viaduct at Hircan. Another mission subjected Mantes-Gassicourt to a second

[REDACTED]

assault. The mediums began their attack on Seine bridges on 8 May with the bridge at Oissel as their targets, and repeated the action on the two following days. Hit on 9 May, the Oissel bridge was classed as unserviceable on the 10th.

Meuse bridges were first assaulted on 8 May when dive bombers severed the bridge at Mozieres and mediums covered that at Namur with an excellent pattern. Illus and Sedan were also dive-bombed on this day, while Mahon was attacked on 9 and 10 May.

The program was more narrowly defined by an AEAFF directive dated 10 May 1944. This listed four Meuse bridges as fifth priority targets for the Ninth Air Force and prescribed that no attacks of any kind should be made on Seine bridges until further notice. These restrictions were maintained until 24 May. Under them the bridges at Liege were attacked by fighter-bombers and mediums on 12 May, and those at Heerenthals and Hasselt by fighter-bombers on 12 and 13 May. Decisive results were not obtained except in the case of Heerenthals, where pilots reported the bridge "probably destroyed."

By directive dated 24 May 1944, AEAFF opened for attack seven bridges over the Seine between Paris and Rouen, and added to the target list four road bridges over the same river. On 26 May rail bridges were given "first priority over all other targets with the Seine bridges at the top of the priority." This did not preclude attacks against bridges over the Meuse. The three bridges at Liege were heavily attacked by mediums on 25, 28, and 29 May, and all were reported severed. Hasselt bridge was attacked by fighter-bombers,

[REDACTED]

[REDACTED]

once on 25 May and twice on 28 May, and reported destroyed. However, interest and attention centered upon the Seine rail and road bridges between 24 May and D-day, since these constituted vital targets in the general program designed to isolate the battle area in Normandy.

Rail bridges at 10 points, and road bridges at 14 others over the Seine appeared on the target lists for the period involved. Of the rail bridges, that at Vernon had been destroyed by dive bombing on 7 May. Those at seven other places were rendered impassable by 4 June. The fifth in a series of dive-bombing attacks accounted for the last of the Conflans bridges. Le Manoir was broken as the culmination of four dive bombings, and the bridge at Rouen destroyed as the result of five such assaults.

Mediums destroyed bridges at four other points. At Le Mesnil Ande an attack by two groups produced the desired effect. At Mantecourt two attacks, by two and five groups respectively, denied the enemy the use of the East and South bridges. Oissel bridge succumbed to the attack of a single group of mediums, while that at Orival was reported destroyed after two such attacks, the first by two groups and the second by one group. Bridges at St. Germain and at Maisons Lefitte alone remained standing. Both lay close to Paris and were heavily defended by flak. The first was dive-bombed once without result. The second was twice attacked by mediums, once by four and once by two groups, but damage was limited to the approaches. By D-day all rail bridges over the Seine from Conflans to Rouen (inclusive) had been rendered impassable by Ninth Air Force attacks.

[REDACTED]

Rolling Stock

Strafing attacks on rolling stock by fighter-bombers supplemented the attacks on rail centers and bridges by the destruction of locomotives and other rolling stock on enemy-controlled lines. The most notable of such attacks occurred on 21 May 1944--a day whose results caused it to be given the appropriate title of "Chattanooga Day." No less than 13 group missions were launched against rolling stock in France north of the river Loire. Weather prevented attacks from being delivered by two groups, but a total of over 500 aircraft found and strafed the type of target assigned. Pilots' claims for the day's operations were 46 locomotives destroyed, 11 probably destroyed, 21 damaged, with 30 trains damaged in varying degrees. Nine of our planes were lost in these operations. Five days later, on 23 May, three groups strafed rolling stock--two in the Rhineland and one in northern France. A total of 97 aircraft delivered attacks. Five were lost, but the pilots claimed 51 locomotives destroyed and 14 damaged, in addition to damage done to other rolling stock. At least seven missions of 2, 3, and 4 June, directed against railway targets, indulged in bombing and strafing attacks on trains. Although pilots reported generally good results their claims of rolling stock destroyed were small.

The above attacks on rail and road bridges, together with those upon rolling stock, constitute an essential preamble to the more formal and more fully developed Interdiction Program of June and the months immediately following. The objectives were the same, the over-all purpose was identical, and the reduction of enemy facilities

[REDACTED]

and, more particularly, the destruction of the Seine bridges were the premises upon which the later program was built.

Attacks on Coastal Batteries

Although individual enemy batteries designed to defend the coast of northern France had occasionally served as targets for the Ninth Air Force prior to 13 April 1944, it was not until then that a definite program against them was inaugurated. An AEMF directive dated 13 April 1944 prescribed that the Ninth Air Force and the 2d Tactical Air Force RAF should concentrate the necessary bombardment effort on 12 listed batteries "to the end that the harassing effect of our attacks shall prevent the completion by the enemy of the construction now going on on specified targets." The targets were divided into two groups of six each. In each group two were batteries under construction, and the remainder were completed installations. Nearly all of the targets under construction lay within the invasion area. The others extended as far east as Dunkirk in the Pas de Calais. For security reasons it was stipulated that two attacks should be made upon completed batteries for each one on a battery under construction. These principles were in their essence maintained in later directives which added new targets to those first provided.

Medium bombers of IX Bomber Command monopolized the attacks on these targets. Between 13 and 30 April they bombed gun positions at 24 places in missions of at least one-group strength. Targets in two places were twice bombed. In May gun positions in 24 places were

[REDACTED]

[REDACTED]

bombed by the mediums. Single attacks were delivered against the installations at six places, two at 12 others, three at three points, and four at two more; while Etaples was six times attacked. Only one attack was in more than group strength. In the first five days of June similar targets in 10 localities were attacked at least once each.

The effects of this program are exceedingly difficult to assess. By scattering the attacks beyond the invasion area security in respect to invasion plans may have been strengthened. The targets were small and of a nature which required direct hits to effect demolition. Even an excellent bomb pattern might fail to produce such hits. Since the framers of the directive of 13 April were aware of these facts it is to be assumed that they used the phrase "harassing effect" rather than the word "destruction" advisedly. Pilots' reports of damage inflicted varied greatly, and photographic evidence added but few significant details. Nevertheless, the effect of such a sustained program upon the enemy's mind and morale may well have been considerable.

Reconnaissance Activities--Visual and Photographic

Throughout the period from 15 May through 5 June the reconnaissance groups of the Ninth Air Force were exceedingly active in discharging functions closely related to current operations, and likewise in gathering information relevant to operations associated with the forthcoming invasion. They also had a definite role assigned in connection with the deception or cover plan then in effect.

[REDACTED]

[REDACTED]

Tactical Reconnaissance planned eight missions daily in the area north of the Seine River in connection with the deception plan. Pilots were instructed to report troop movements, concentrations of troops, and activity on railroad yards and airfields. They were also to report suitable fighter-bomber targets by E/T. The routes and times of entering France were varied each ^{day} with the bulk of the reconnaissance laid north of the Somme River to a depth of 100 miles from the coast.

Between 23 February and 20 March 1944 the Tactical Reconnaissance Group flew 83 missions to obtain Herton obliques of 160 miles of the French coast line and of two in-shore strips, each 120 miles long. This usually involved flying at 3,500 feet and at a straight flight line for four minutes. In spite of the size of the task and the dangers involved, 9,500 prints were turned in. No planes were lost. New low-level obliques were obtained of proposed landing and drop zones in the invasion area for study by LX Troop Carrier Command and the airborne divisions. For deception purposes each mission of this type executed in the invasion area was matched by two others, executed in exactly the same manner, in the region of the Pas de Calais.

It should be noted that when weather or cloud base precluded photography on the part of high-altitude photo reconnaissance units accompanying the medium bombers, and when a prompt report of visual observation was required, pilots' visual observations were relayed by E/T to the sector controller, who forwarded them to the reconnaissance center at advanced headquarters. Such information could be furnished within one-half hour from the time of bombing. When possible, bomb-damage assessment photographs were made at the same time.

[REDACTED]

[REDACTED]

A total of 400 tactical reconnaissance sorties were flown by the Ninth Air Force during this period, in addition to the special task of flying 140 weather reconnaissance sorties.

During the same period from 15 May through 6 June, photographic reconnaissance was employed to the maximum to provide the photo coverage required by armies and air forces. This work was closely coordinated with British agencies and equitably divided between the PAF and the American facilities available.

The Ninth Air Force Photographic Group completed the following tasks within this period:

- (1) Mosaic of the area within a 12-mile radius of the Liege bridges for a IX Bomber Command study of the flak defenses in the area prior to bombing operations
 - (2) Coverage of all occupied airdromes and airdromes previously occupied by the German Air Force in northern France
 - (3) Run-in, nose-dicing strips for IX Troop Carrier Command's use in briefing and to assist pilots in making proper landfalls
 - (4) Mosaics of landing and drop zones for IX Troop Carrier Command and the airborne divisions
 - (5) Medium-scale coverage of all main roads in the invasion area every four days from 23 May to D-day
 - (6) Medium-scale coverage of all bridges over the Seine River as far inland as Paris.
 - (7) Medium-scale coverage of all bridges over the Loire River from Nantes to Orleans
 - (8) Special large-scale coverage of landing and drop zones on D minus 1 to enable IX Troop Carrier Command and the airborne divisions to study obstacles which were reported to be under construction in these areas
- [REDACTED]

- (9) Eleven extraordinary sorties flown to obtain low-level obliques of underwater beach defenses. These sorties were flown at zero altitude plus sufficient elevation to clear the obstacles on the beaches. Nose-dicing and side-dicing cameras were used, and the flight path usually maintained midway between high-water and low-water line. These photographs were invaluable in that they provided the details of construction of the obstacles themselves. They also disclosed the teller mines and high explosive shells fastened to the several types of obstacles. Their information assisted the Navy in dealing with the mass of underwater obstacles which the enemy had constructed as a defensive measure.

Supplementary Actions of Fighters and Bombers

Supplementing the work of Tactical Reconnaissance and Photo Reconnaissance in connection with operations in progress in this same period were the reports of returning Ninth Air Force pilots of the medium and fighter-bombers. Acting on the principle that such reports might well constitute a most substantial source of information, all pilots had been specially trained to observe and to report their observations. A conspicuous case where such action paid dividends had occurred on 23 April 1944. Fighter-bomber pilots returning from a mission over Namur marshalling yard reported the largest concentration of rolling stock there which they had ever seen. The information was received at Advanced Headquarters Ninth Air Force at 1440. By 1944 hours a group of fighter-bombers and four groups of mediums had bombed the target with resulting heavy damage to choke points, sidings, and rolling stock. Such a case is obviously exceptional, but the sum total of information brought in by combat pilots was both great and useful. Training in accurate observation and in the establishment of good reporting procedures was bearing good fruit. It was to prove its value in the course of later operations.

[REDACTED]

placed at Charney Down in Wiltshire and at Scorton, Yorkshire.

Headquarters Ninth Air Force and its advanced headquarters were fixed at Sunninghill Park, Berkshire, and at Uxbridge, Buckinghamshire respectively. Headquarters IX Fighter Command was at Middle Wallop, Hampshire, and its advanced headquarters at Uxbridge. Headquarters IX Tactical Air Command was also at Middle Wallop. Headquarters XIX Tactical Air Command was located at Aldermaston Court, Berkshire, and its advanced headquarters at Biggin Hill, Kent. IX Bomber Command Headquarters remained at Marks Hall, Essex. Headquarters of IX Air Force Service Command was located at Sunninghill Park, that of IX Engineer Command at Bray Court, Berkshire, and that of IX Air Defense Command at St. John's Wood, London. IX Troop Carrier Headquarters remained at Grantham, Lincolnshire, but its advanced headquarters was fixed at Eastcote, Middlesex.

The movements incident to this tactical redeployment of the Ninth Air Force afforded an excellent opportunity to give the units involved in the movements experience which it was believed would be of value to them as they made changes of station to, or on, the continent. Mobility exercises, therefore, coincided with the movements made. In addition, groups not scheduled for an immediate change of station were directed to carry out such exercises by leap-frogging between airfields, or by a movement from the station occupied out into the adjacent countryside and back again. Wherever possible the necessary transportation was provided to allow these exercises to be carried out in a manner identical with that of a genuine operation. Where

[REDACTED]

[REDACTED]

transportation was not available it was necessary to simulate the existence of transportation; e.g., to stake out a space on the ground equal to the area of a truck body, and to stack equipment therein. In all cases the mobility exercises involved the movement of all available personnel and materiel, and their reestablishment in readiness for operations. All measures which would be observed in a movement within an active theater of operations were observed in the course of these exercises.⁶

Provision of Facilities for Air-Ground Cooperation

The success of the operations of a tactical air force depends in large measure upon the degree of cooperation which exists between it and the Army units with which it is associated. To achieve such success a variety of measures was taken by the Ninth Air Force.

Conferences

Beginning in December 1943, a series of conferences was held at Ninth Air Force Headquarters, Sunninghill Park. Here high-ranking ground commanders, together with the ground liaison officers who were to operate with Ninth Air Force units, were given full information as to the resources and capabilities of air power. Such conferences were addressed by the Commanding General, Ninth Air Force, by the Commanding Generals, IX Bomber Command, IX Fighter Command, and IX Troop Carrier Command, and by other specially chosen officers.

[REDACTED]

Ground Liaison Officers

It was designed that the ground liaison officers, composed of Army personnel, should assist air force units in developing a full picture of the ground situation, that they should help in the briefing of air crews preparatory to their taking off on missions, and that they should pass on information obtained after missions had been flown to the proper ground headquarters. They were assigned to headquarters and wings of IX Bomber Command, to headquarters, wings, and groups of the IX and XIX Tactical Air Commands, and to the tactical and photographic reconnaissance groups. They functioned in close association with air force S-2's and S-3's.

To supplement the information obtained at the conferences at Sunninghill Park, the ground liaison officers attended a special Command Post Exercise at IX Tactical Air Command designed to demonstrate significant points in the doctrine of air-ground cooperation. They further attended a two-week course at the RAF School of Army Cooperation at Old Sarum.

Air Support Parties

Air Support Parties, composed of air force personnel, were assigned to Army corps, divisions, and regimental combat teams. Their function was to assist the proper Army authorities in formulating requests for air strikes, in which connection their knowledge of the capabilities of air power would be of special value. Each party was provided with mobile ground-to-ground and ground-to-air communications

[REDACTED]

to enable it to send requests for air strikes promptly, and to direct aircraft that were searching for their targets. IX Tactical Air Command furnished the personnel for 15 Air Support Parties.

Cooperation with Units Afloat

To further the cause of air-ground cooperation Ninth Air Force Air Representatives were assigned to the flagships of the Western Naval Task Force and Controllers to three fighter direction tenders. The U.S.S. Augusta was the Western Naval Task Force flagship and for a time carried the Commanding General, First U. S. Army and key members of his staff. The U.S.S. Ancon was the Assault Force Omaha flagship and headquarters ship for V U. S. Corps and 1st U. S. Division. The U.S.S. Bayfield was the flagship for Assault Force Utah and headquarters ship for VII U. S. Corps and the 4th U. S. Division. U.S.S. Henrico was relief ship for U.S.S. Ancon, and U.S.S. Bayfield. One fighter direction tender was located off the American beaches, another off the British beaches, and the third in the shipping lane.

Controllers and Air Representatives

The role of the Controllers in the fighter direction tenders was to assist in the operation of Ninth Air Force aircraft in the essentially defensive operations of shipping and beach cover. The role of the Air Representatives on board the flagships was to assist in the provision of offensive air-ground cooperation by the Ninth Air Force. They were to keep the Commanding General, Ninth Air Force

[REDACTED]

[REDACTED]

informed of the operation's progress at his Uxbridge headquarters. They were to give air advice to the Commanding General, First U. S. Army, to the Naval Commander, Western Task Force, and to the commanding generals of corps and divisions. They were further to examine calls for air coordination passed back to the United Kingdom by the Air Support Parties ashore and to confirm or veto these calls in consultation with the ground force and naval commanders. They were further to originate requests for air-ground cooperation, pass weather information, and give direct to the Commanding General, Ninth Air Force information as to the bomb line. The Air Representatives on the assault force flagships were to rebrief, or redirect if necessary, the fighters or bombers which arrived in response to those calls or in accordance with a set program. They were to request additional reconnaissance if such were required by corps or division commanders, to redirect reconnaissance aircraft if necessary, and to receive radio-telephone reports from these aircraft whenever such reports were made direct. Such devices gave added guarantee that air-ground coordination would be effective.

Coordination Facilities at Uxbridge

By 21st Army Group memorandum, subject Direct Air Support, dated 23 April, it was stated that "The successful application of direct air support depends on two broad principles: (a) That the support afforded conforms with the military plan. (b) That the air support applied achieves the greatest effect. The Army Group Commander will, therefore,

[REDACTED]

[REDACTED]

make his intentions known to the Air Force Commander and the latter will apply the air effort in the best way to further the Army plan."

To give effect to the above policy various organizations were established in close working proximity to one another at Hillington House, Uxbridge, in the period prior to D-day.

Advanced Headquarters Allied Expeditionary Air Force

Advanced Headquarters AAEF was one such organization. It provided the Ninth Air Force and 2d Tactical Air Force RAF with target directives. It resolved any questions which might arise and served to assist in determining the employment of the United States Strategic Air Force in cases where its use appeared necessary.

Advanced Headquarters Ninth Air Force and 2d Tactical Air Force RAF

Advanced Headquarters Ninth Air Force was established at Hillington House in early February 1944 as essentially an operational headquarters. Its operational personnel shared the same operations room with equivalent personnel of 2d Tactical Air Force and developed their actions in cooperation with the latter.

Combined Control Center (Fighter)

In similar fashion Advanced Headquarters IX Fighter Command, in operational control of IX and XIX Tactical Air Commands, took up its residence at Uxbridge by the side of 11 Group RAF in what was known as the Combined Control Center (Fighter).

[REDACTED]

████████████████████

21st Army Group Combined Control Center

The 21st Army Group Combined Control Center also appeared on the scene to give the needed representation to the ground forces. It was headed by a general staff officer (air) of 21st Army Group. Its personnel, derived from 21st Army Group and from the First U. S. Army, were distributed among three subordinate groups or cells.

Reconnaissance Center. The first of these cells was the reconnaissance center. This handled all requests for reconnaissance which were not cared for by reconnaissance units directly assigned to armies. It had the further responsibility of planning reconnaissance missions in advance and of planning missions on its own initiative, if in its judgment such missions were necessitated by the developing situation. It furthermore received reports of all reconnaissance missions. These it forwarded to the information cell which, in turn, transmitted them to the operations cell and to the operations room for their information and possible action. Direct control of American reconnaissance was maintained by the senior U. S. officer in the reconnaissance center.

Operations Cell. The second cell of the 21st Army Group Combined Control Center was denominated the operations cell. This unit received all requests for air participation originating with U. S. Air Support Parties (or British visual control posts) which, as noted above, were assigned to ground troops. These requests conveyed the wishes of

████████████████████

[REDACTED]

ground commanders in respect to such missions. In the assault phase they emanated from the headquarters ships. As the Army units involved moved ashore the requests came from their command posts. Such requests might also come directly from the ground commanders.

The operations cell might reject such requests, or it might pass them on to the appropriate operations room for acceptance or refusal. Refusals on the part of operations room authorities would normally be only on grounds of air necessity. This cell might also develop requests for air-ground cooperation on its own initiative and on the basis of its knowledge of the ground situation. It was kept fully informed on the details of this subject by way of reports received directly or through information cell, ground units in the field, or reconnaissance. A situation map portrayed this information graphically.

Operations cell had two other functions. It assisted in the development of the missions planned in advance for any given day. On the basis of information received from the ground it set the bomb line, altered the same as need arose, and gave prompt information on the subject to operations room and to the ground and air units concerned.

Information Cell. The third element of the 21st Army Group Combined Control Center was the information cell. To it all intelligence concerning the ground situation was reported by the ground units involved. As has been noted above, it also received reports of air reconnaissance, to which sources of information were added the reports of observations made by other air missions. This cell maintained a situation map on

[REDACTED]

[REDACTED]

which the changing positions of friendly and enemy troops were constantly displayed, together with the reported results of reconnaissance. It likewise maintained and circulated to interested units an "Information In Log" in which all items of intelligence received by it were entered.

Once it was determined that an air participation mission should be flown, operations orders were sent, usually by telephone, to the proper air S-3. The same information was likewise given to the ground liaison officer attached to the air formation involved, in order that he might inform the ground commander and personally assist the S-2 in briefing the crews on appropriate details of the ground situation. He was kept currently informed on this subject so that he might properly discharge this briefing function. If a request was refused, the ground commander who originated it was so informed.

Final Instructions to Ground Liaison Officers

Further to inform the ground liaison officers with respect to details of the invasion plan with which they needed to become familiar, a special conference was held for their benefit at Hillingdon on 2 June 1944. These officers of the 21st Army Group Combined Control Center indulged in a full exposition of the plan, repeated earlier statements in respect to the procedures employed in laying on air-ground cooperation missions, and provided each ground liaison officer with a carefully developed set of instructions for his reference in the immediate future. The fact was stressed that while the greater part of air-ground cooperation missions would be prearranged, missions

[REDACTED]

in response to demands arising from unforeseen situations, though smaller in proportion, were exceedingly important.

Later Developments

This plan and organization for the control of air strikes was maintained without substantial modification throughout the period 6 to 18 June. However, as operational bases were established on the far shore in immediate proximity to First U. S. Army, the activities of the 21st Army Group Combined Control Center were progressively limited. A definite stage in this development, so far as U. S. air power was concerned, was reached on the night of 17-18 June 1944. Then, in accordance with an order from Advanced Headquarters IX Tactical Air Command on the far shore, operational control of air-ground coordination missions was assumed by that headquarters. In effect this meant that the control of the fighter-bombers passed to that command. Preplanned air participation missions were still arranged and ordered by Advanced Headquarters Ninth Air Force at Hillington House, and other missions were ordered there in cases where the local resources of IX Tactical Air Command did not permit it to care for them.

Of necessity an elaborate communications net was maintained for the use of 21st Army Group Combined Control Center which gave them direct communications with both ground and air units.⁷

[REDACTED]

Chapter III

OPERATIONS 6 TO 30 JUNE 1944

D-Day Operations

The invasion plans of the Ninth Air Force had been fully elaborated on paper in "Ninth Air Force Plan for Operation 'Neptune'--Tactical Air Plan," issued on 26 April 1944. On D-day, 6 June 1944, the first of these plans was translated into action as the actual invasion of Europe began. All of the Ninth's vast resources had been committed by the plan. All were now employed to the fullest possible extent--troop carriers, medium bombers, and fighter-bombers alike.

IX Troop Carrier Command

Field Order No. 1

IX Troop Carrier Command Field Order No. 1, 31 May 1944, as amended 4 June 1944, determined the role of that organization in the assault phase of Operation NEPTUNE. The assigned mission of Brig. Gen. Paul L. Williams' forces was to "transport and re-supply parachute and glider elements of the 82d Airborne Division and the 101st Airborne division." This was to be accomplished in three phases. The first, to be accomplished in the early hours of D-day, involved the delivery of parachute and glider infantry of the two airborne divisions on a total of six drop or landing zones in close proximity to Ste. Mere Eglise, where they were to be used to assist the inland progress of the assault troops landed on Utah beach. The second, involving the

[REDACTED]

support of the two divisions with glider-borne headquarters, medical, signal, and engineer detachments, together with field artillery, anti-aircraft artillery, and infantry units, was to be accomplished late on D-day and in the early hours of D plus 1 at two landing zones, one of which had not been previously employed. The third, to be carried out early on D plus 1, involved parachute resupply of the airborne divisions at two drop zones earlier employed.

Take-Off, Course, and Formations

In the closing hours of D minus 1, C-47's and C-53's of IX Troop Carrier Command began to take off, some serving as tugs for CG-4A's. No less than 15 airfields, distributed in three major areas from Lincolnshire to Devon, were employed in the operation, which was directed from the Combined British American Operations Room and Command Post at Eastcote, in proximity to Advanced Headquarters Ninth Air Force and Headquarters Allied Expeditionary Air Force.

Aircraft proceeded to three wing assembly areas and thence to the command departure point on the coast. From that point the air trains proceeded along a command channel 10 miles wide, passing between the islands of Guernsey and Alderney to a turning point off the west coast of the Cherbourg peninsula. The course was planned to avoid the heavy anti-aircraft fire of the Channel Islands and northern portion of the Cherbourg peninsula. Three naval craft, provided with visual and radar beacons and carrying Signal personnel of IX Troop Carrier Command, marked the course and turning point.

[REDACTED]

[REDACTED]

Aircraft carrying paratroops proceeded in nine-ship column Vee of Vees, while glider tug and their tows were formed in pairs of pairs echeloned to the right. The former observed a speed of 140 m.p.h., the latter a speed of 130 m.p.h. en route; and both were to return to 150 m.p.h. To avoid excessive casualties paratroop drop speed was fixed at not over 110 m.p.h.

Pathfinders

Six pathfinder serials of three planes each were directed to proceed to six drop and landing zones. Their navigators were the most experienced members of the IX Troop Carrier Command Pathfinder School, where their crews had also been trained. This school had provided intensive training in the use of all navigational aids since its establishment on 1 March 1944, and its members had participated in frequent wing and command exercises. The pathfinders' mission was to drop at least one of three airborne pathfinder teams on each of the six drop zones assigned, the teams to mark the zone with lighted beacons and radar beacons one-half hour before the arrival of the main body. The pathfinders were also to drop at least one of two airborne pathfinder teams to mark a special glider landing zone.

All 18 pathfinder aircraft which made landfall completed their missions, and all drops were made at approximately the correct times, although some difficulties were encountered at the turn and immediately after landfall. All planes were equipped with Gee, with Rebecca (to receive Eureka beacons), and with SCR-717-C radar, so that in case one or more of the devices failed the mission could still be

[REDACTED]

[REDACTED]

carried out. All of the equipment worked satisfactorily with the exception of the SOE-117-C reception of signals from Eups beacons. SOE-117-C was used to determine the exact landfall on passing the British coast, to fix course exactly midway between Alderney and Guernsey islands, and as a check to Gee in reaching the drop zones and on returning to base. Rebecca received Eureka signals at all check points and at three drop zones. At no time was Gee unreadable. In two cases, the actual drops were made by its use alone, while in three others Gee was supplemented with good visual checks. In the remaining two instances the pathfinder teams were dropped on visual identification of the target. In one instance three teams were dropped within 500 yards of the center of the assigned drop zone.

Diversion

A force of RAF Stirlings flew a diversionary mission in connection with the first phase of troop carrier operations. They paralleled the course of the main column and continued beyond the turning point towards the enemy coast, dropping window to simulate a second troop carrier force going to a different area in serials of approximately 40 aircraft each. Dummy paratroops and noisemakers were also dropped in the course of this diversion.

Escort

Escort was provided by night fighters of 11 Group RAF which provided covering for the column, while RAF intruders assisted in providing cover and attacked enemy guns and searchlights. No enemy aircraft were

[REDACTED]

encountered in this or any subsequent phase of the operations.

Progress of the Operation

First Phase. Over 900 C-47's and C-53's of IX Troop Carrier Command, together with more than 100 CG-4a gliders, participated in the first phase of the operation in 28 serials. Thanks to intensive training in night flying, all formations were effected without air accident. Transport navigation problems were usually solved in a satisfactory manner. Two crews per group had been specially trained in the Pathfinder School to lead their groups within visual distance of the drop-zone aids established by the airborne pathfinder units. All formations reached the targets at approximately the time designated without receiving any gunfire from Allied ships. Navigational aids functioned satisfactorily with the exception of the lighted teas on three drop zones. There, however, the Lureka beacons worked well. Heavy cloud formations obscured vision and rendered the special run-in maps of little value. The aircraft reached the drop zones between 0016 and 0404 hours on D-day.

Surprise was possible only in the case of the leading aircraft; all subsequent serials were under practically continuous ground and antiaircraft fire in crossing the peninsula and on landing. While receiving such fire the transport serials were usually unable to maintain close formation with the result that airborne units were scattered and intermingled on landing. Nevertheless results differed from the plan in detail rather than in mass, and the ground observer's report

[REDACTED]

indicates that the units of the 101st Airborne Division were dropped without major loss and that only one unit of the 82d Airborne Division was badly dropped. The same observer remarked that the successful conclusion of the glider phase of the mission was "little short of a miracle," since the landing fields were small and often obstructed by heavy posts. Parachute and glider landings alike had to be made in the midst of a strongly organized defensive position. This fact was emphasized in the case of the 82d Airborne Division, which landed squarely on the German 91st Infantry Division and other defense troops engaged in maneuvers and occupying their assigned defense positions.

Second Phase. Over 400 C-47's and C-53's towing as many CG-4A and Horsa gliders participated in the support missions (nine serials) on the afternoon of D-day and on the morning of D plus 1. They were escorted by fighter groups of IX Fighter Command which gave close cover.

The results were much the same as those recorded for previous missions. CG-4A's had been employed for the night glider landings since it was held that their size would keep night losses to a minimum. Two hundred and twenty Horsas were assigned to this phase, their pay loads of 6,900 pounds making them particularly valuable for the transport of heavy equipment. Small landing fields again occasioned many crash landings, the high landing speed of the Horsas placing them at a special disadvantage. Again formations were considerably scattered by ground fire. Some of the landings were made in the midst of the battle which was raging in the Ste. Mere Eglise area. Under

[REDACTED]

[REDACTED]

these circumstances considerable heavy equipment was lost, there being little opportunity to secure that which was safely landed; but casualties were reported as "amazingly light." The aircraft arrived over their targets between 2053 and 2250 on D-day and between 0700 and 0855 on D plus 1.

Third Phase. The work of IX Troop Carrier Command in the assault on Utah beach was concluded by phase three of its operation. Paralleling some of the support missions above described, more than 320 C-47's and C-53's were dispatched to resupply the 82d and 101st Airborne Divisions on the morning of D plus 1. Ground conditions and enemy reactions were averse to the successful accomplishment of resupply. In addition, this phase was carried out as preplanned and not on orders framed in accordance with the actual ground situation. These facts in combination caused many bundles of the mass drop to fall in enemy territory, while the location and distribution of others by the ground troops constituted a difficult problem.

Accomplishments

The difficulties attendant upon an operation of this magnitude were serious and many. Planning had anticipated many. Others had been reduced to a minimum by the navigational and other technical training afforded by the IX Troop Carrier Command Pathfinder School. Furthermore, no less than 30 wing and three command exercises had been conducted by IX Troop Carrier Command between 15 March and 27 May

[REDACTED]

to give its air crews operational experience. Airborne troops participated in all of these exercises which culminated on 12 May 1944 in Exercise Eagle--a full-scale and realistic rehearsal of invasion operations. The fruits of such planning and training were gathered in the course of the troop carrier operations of D minus 1 to D plus 1. These operations were a success. The following tables constitute a record of their size, cost, and accomplishment.¹

IX Troop Carrier Command: Operational Summary

Aircraft

Dispatched	1,660
Sorties	1,606
Completing mission	1,581
Abortive	76
Missing and destroyed	41
Damaged	449
Troops dropped on objective	13,215
Artillery weapons dropped	223
Pounds of combat equipment and supplies dropped	1,641,448
Flying time (hours)	7,092

Gliders

Dispatched	512
Sorties	512
Released at LZ	503
Not released at LZ (lost)	9
Troops landed on objective	4,047
Troops not landed on objective	43
Artillery weapons landed	110
Jeeps landed	231
Pounds of combat equipment and supplies landed	412,477
Flying time (hours)	1,118

Percentages

Aircraft abortive	4.6%
Aircraft destroyed and missing	2.5%
Aircraft damaged	27.0%
Gliders not released at LZ (lost)	1.5%

Troops dropped or landed

Aircraft	13,215
Gliders	<u>4,047</u>
Total	17,262

25-25 [REDACTED]

Pounds of freight dropped or landed

Aircraft	1,641,448
Gliders	<u>412,477</u>
Total	2,053,925

Analysis of combat equipment dropped or landed

	<u>Aircraft</u>	<u>Gliders</u>	<u>Total</u>
Number of jeeps	0	291	291
Number of artillery weapons or mortars	233	110	333
Gallons of gasoline	1,667	230	1,947
Pounds of mines and explosives	16,237	10,355	26,652
Pounds of ammunition	596,621	202,062	798,683
Pounds of rations	81,701	5,672	87,373
Pounds of other combat equipment	946,929	194,333	1,141,217

Bomber and Fighter Commands

Operations Order No. 168A

The assault phase operations of IX Bomber Command and of IX Fighter Command for D-Day were determined by Advanced Headquarters Ninth Air Force Operations Order No. 168A (no date). Its essential provisions, based upon the Joint Fire Plan of 8 April as subsequently revised and amended, were as follows:

IX Bomber Command, under the command of Brig. Gen. Samuel D. Anderson, was to attack three coastal batteries in the 21st Army Group area, one near Benerville and two in the vicinity of Ouistreham. Eighteen aircraft were to bomb each target at or near civil twilight as possible.

Three other coastal batteries at Pointe du Hoc, just west of Omaha beach, at Maisy I on the eastern shore of the Vire estuary, and at Montfarville, south of Barfleur on the northeast tip of the Cherbourg peninsula were to be attacked by 18 mediums each between H-hour minus 20 and U-hour minus five minutes. All these batteries

[REDACTED]

were capable of interfering with the landings on Utah beach.

In addition the mediums were to bomb seven defended localities in the Utah beach area in the vicinity of Les Dunes de Varreville, St. Martin de Varreville, La Madeleine, and Beau Guillot. Three were to be attacked by 36 and the remainder by 54 aircraft each. The attacks were to be delivered between H-hour minus 20 and H-hour minus five minutes. The medium-bomber effort was concentrated in this area to eliminate, so far as possible, air traffic problems.

The strength of groups during the assault missions was fixed at the maximum of 54 aircraft. Medium formations were to have no direct fighter support, but were to be under area cover.

IX Fighter Command was in operational control of all IX and XIX Tactical Air Command units, and was under the command of Maj. Gen. Elwood R. Quesada. Five groups were assigned to beach high cover, two (supplemented by four from VIII Fighter Command) to convoy cover. Five other groups constituted a striking force, and six were held for support (air-ground cooperation). Two fighter-bomber squadrons, designated from the striking force, were assigned to fly one air alert mission each, in support of the U. S. V and VII Corps, as directed by the Combined (Fighter) Control Center in direct coordination with the commanders of those corps.

In addition the fighter-bombers were to attack two coastal batteries in squadron strength. These were Maisy II and Gefosse, both on the eastern shore of the Vire estuary and both capable of delivering fire on Utah beach. The attacks were to be made between H-hour and H-hour plus 10.

[REDACTED]

With the purpose of blocking movement into the Utah area, fighter-bombers were assigned six bridges and a rail embankment in the general area southwest of Ste. Marie Eglise and in proximity to St. Sauveur le Vicomte. The embankment was at La Sangaurière, the bridges at Bouzeville, Ebiannville, Courpeville, St. Sauveur de Pierre Pont, St. Sauveur le Vicomte, and Nohou.

Intelligence Appreciation of Assault Phase Targets

The nature of these targets is exhibited by Intelligence Section's "Appreciation of Scheduled Targets for 6 June 1944," which follows.

IX Bomber Command

GUN BARRIERS

Farfleur (Montfarville)

Casemates under construction for four 170 mm. guns with range of 32,000 yards. Previously attacked 12, 19, 22 and 24 May by IX Bomber Command, resulting in damage to all four casemates. One of the four guns was possibly destroyed and another may be out of action. The remaining two guns may be able to fire but probably from adjacent sites and not from the incomplete emplacements.

Weak to moderate heavy flak is anticipated.

Maisy I

Four emplacements for 155 mm. howitzers consisting of open circular pits 35 in diameter with concrete platform. Attacked 23 May by IX B.O. by blind bombing methods, causing no damage. Casemates are under construction in the vicinity.

Weak heavy flak may be encountered.

Pointe du Hoc

Emplacements with six 155 mm. guns. Also casemates under construction. Attacked by IX Bomber Command on 16 April, 22 May and 4 June have damaged all but No. 2 and No. 3 position.

Weak heavy flak may be encountered.

Benterville

Six gun 155 mm. battery with 4 casemates under construction. Attacks of 23 April and 12, 19 and 20 May effected only minor damage. Weak heavy flak may be encountered.

Quistrakha I

Six 155 mm. guns with 4 casemates under construction. Attacks of 27 April and 4 May severely damaged No. 1 and No. 2 casemates. Weak to moderate heavy flak is anticipated.

Quistrakha II

Six 155 mm. guns with 4 casemates under construction. No damage from prior attack. Weak to moderate heavy flak is anticipated.

DETACHED LOCALITIES IN ULAZ BEACH AREA

Les Dunes de Yarraville

Infantry position on coast. Two pillboxes, five shelters, possibly one anti-tank gun. Protected by anti-tank ditch and wire on landward side.

La Geleina

Infantry position on coast. Two pillboxes, three shelters, possibly two 150 mm. guns. Protected by wire on landward side.

St. Martin de Yarraville

Infantry position on coast. Four pillboxes, one shelter, three anti-tank guns, one light gun, probably 75 mm. protected by wire on landward side.

St. Martin de Yarraville

Infantry position on coast. Three pillboxes, six shelters. Protected by wire on landward side.

La Madleine

Small infantry position slightly inland, surrounded by wire.

Recu Guillot

Small infantry position inland from coast. Probable platoon Headquarters.

Beau Guillet

Infantry position on coast in front of dyke. Two pillboxes. No heavy flak is anticipated at any of these beach targets. Light flak and small arm fire will be encountered if low flight is necessary.

IX NIGELLE COMMANDGUN BATTERIESGefosse-Montsarrat

A new four-gun battery emplaced in a row of trees lining a road. On 26 May 1944 no minor defenses or wire had yet been installed. It is believed to be a field battery.

Weak heavy flak may be encountered.

Mairix II a

Probable 75 mm. field guns in rough open earthen emplacements 20-25 feet in diameter sited in an open field. Range of guns about 13,000 yards.

Weak heavy flak may be encountered.

SEIBOESNeuzeville--Road Bridge

Single span through lattice girder bridge with masonry abutments. Span is 50 feet long over Douve River.

Thierneville--Road Bridge

Three bridges in succession over Douve River and two branch streams. (1) Brick arch, single span, 45 ft; (2) Decked steel lattice girder, 2 span, 30 ft; masonry arch single span, 45 ft.

Courpaville--Railroad Bridge

Single track railroad bridge on Carentan-La Hoge du Puits-Carteret line.

St. Sauveur de Pierre Pont--Railroad Bridge

Single track railroad bridge.

St. Sauveur le Vicomte--Road Bridge

Reinforced concrete, two span bridge 100 feet long, over Donne River.

Nahou--Road Bridge

Masonry arch, 3 span bridge, 70 feet long, over Douve River.

Sancsaurien--Barricament on main road on west side of Cherbourg peninsula.

Light flare only is anticipated at any of these bridge targets.

Note:

Of the gun batteries listed above as targets, the following have portions of both Utah and Omaha beaches within range:

Maisy I - Maisy II - Gefosse - Pointe du Hoc.
The Barfleur Battery can reach Utah beach.

IX Bomber Command Operations in the Assault Phase

All of the assignments to IX Bomber Command for the assault phase were carried out. Zero hour had been fixed at 0630. Accordingly the first aircraft involved took off at 0643, the last at 0800 on 6 June. Under these circumstances it was well that much effort had been expended in training flying personnel in formatting just before dawn.

Weather and pathfinder difficulties reduced the attack on the targets in the 21st Army Group area. Only one aircraft was over Benerville and 11 were over the two batteries at Ouistrehem. The attacks took place between 0517 and 0850, with 1,000- and 2,000-pound bombs being used.

The attack on the batteries at Pointe du Hoc, Montfarville, and Maisy I took place between 0625 and 0645. The results in the first instance were unobserved; in the other two the targets were well covered by the bursts of 1,000- and 2,000-pound bombs dropped visually by single boxes accompanied by pathfinder aircraft.

[REDACTED]

Owing to weather conditions the visual attacks on the seven defended localities in the Utah beach area were made at unusual levels between 3,500 and 7,000 feet. They were delivered by 18 boxes, distributed as planned, and took place between 0605 and 0624. To avoid heavy cratering, 250-pound bombs were employed. Calculations based upon experimental bombing at Dracaster on 11 and 23 May had determined this selection. A total of 269 aircraft dropped 523.63 tons of 250-pound bombs.

Assessment of the results of these bombing attacks is extremely difficult. Poor photographic conditions prevailed which limited the results to be obtained from strike photographs. Later examination on the ground yielded rather unsatisfactory conclusions since the small craters were obscured by the effects of naval gunfire, by later fighting, and by still later cleaning-up operations. Operational Research Section, however, calculated on the basis of 28 located bomb-falls in the Utah beach area that 10 per cent of the bombs fell in the target areas of the seven defended localities, 43 per cent within 500 feet of the target areas, 60 per cent on land, and 34 per cent between high tide and water line. It should be remembered that in an attack by two boxes of 18 aircraft each on such targets the chances of a machine gun's being put out of action are .054. The chance of a direct hit on a pillbox is less than 2 per cent. It is to be observed, however, that reports from the ground commander in the Utah area stated that the pin-point bombing of the beach targets was excellent, and that he later transmitted a commendation to IX Bomber

[REDACTED]

[REDACTED]

Command. In particular the light resistance encountered by a unit of the 101st Airborne Division in occupying a battery west of St. Martin de Varreville was declared by a ground observer to be "due to the excellent air force bombing."

In attacks against coastal batteries, usually housed in heavy concrete emplacements, hits were reported in the vicinity of the guns, but no physical damage attributable to the bombing was discovered at a later date. It is noteworthy that in all bombing of such targets the effect of other than direct hits may have disrupted controls and communications and demoralized personnel, thus effectively neutralizing the gun position at a critical period.

IX Fighter Command Operations in the Assault Phase

Fighter-bombers of the IX and XIX Tactical Air Commands, functioning under the operational control of IX Fighter Command, provided the required convoy and high beach cover throughout the day. They also supported the daylight operations of IX Troop Carrier Command by providing escorts and by carrying out area sweeps. These operations were amazingly uneventful, the only report recording the presence of enemy planes being from aircraft engaged in convoy cover. These reported fighting and chasing off three FW-190's. In fact no claims were made by fighter-bombers in the course of the whole day's operations--the only claims for the Ninth Air Force on D-day being two enemy aircraft destroyed by mediums and three destroyed and one damaged by reconnaissance aircraft.

[REDACTED]

[REDACTED]

Such a record, notably in respect to shipping lane and beach cover, is tribute to the efficient execution of the plans for the provision of such cover by the three air forces participating. It also reflects the success of preliminary operations against the German Air Force which resulted in the destruction of its aircraft in the air and on the ground, and in the destruction of and damage to its ground installations and production facilities. To this success the Ninth Air Force had made its contribution, although major credit belongs to the Eighth Air Force and the RAF. The net result of preliminary operations and the efficient execution of D-day plans was that Allied air supremacy over the vital shipping lane and the equally vital beach area was complete.

In addition to their provision of cover and escort, the fighter-bombers of the Ninth Air Force performed a considerable variety of other missions on D-day. Of the nine special targets assigned to them in the assault phase, five were definitely hit. In the remaining cases reports do not exactly specify the target bombed, but indicate that an equivalent target was attacked. The attacks, usually in squadron strength, were delivered between 0550 and 0633.

The coastal batteries of Naisy II and Gefosse were hit with results reported "good" and "excellent." The attacks were by 13 and 15 aircraft, dropping 27 and 59.5 tons respectively.

Bridges at St. Suvard de Pierre Font, Deuceville, and Courpeville were bombed as assigned. Two others in the same area were also hit,

[REDACTED]

[REDACTED]

while railway installations at Carentan were attacked. Results were reported generally as "fair." A total of 133 planes shared in these assaults on communications and dropped 83.75 tons of bombs.

Other Operations of IX Bomber Command

IX Bomber Command continued its activities throughout the day, dispatching a total of 1,011 aircraft, of which 833 made attacks. This averaged five-plus boxes per group. The best rate of performance hitherto achieved had been an average of four boxes per day. For the first time, more aircraft were dispatched than there were crews available. Hence many crews flew on two missions.

Coastal batteries again served as objectives for the missions. In the British area 100 craters were produced in the target area at Fenerville, and hits were scored near the emplacements of the batteries at Houlgate and Trouville. At Gatteville, on the northwest tip of the Cherbourg peninsula, equally good results were reported. Two boxes attacked in each instance.

Road junctions or highway bridges were attacked at Caen and Falaise in the British area by a total of 83 aircraft dropping 164.25 tons with but small results. In the U. S. area, similar targets in proximity to the battle area were hit at Valognes, Argentan, Epouche, and Carentan. A total of 130 aircraft dropped 165.5 tons on these targets, inflicting appreciable damage.

The missions also attacked four marshalling yards east of the Seine in afternoon missions. Twenty-five B-26's dropped 49.5 tons

[REDACTED]

[REDACTED]

on Amiens with damage to rolling stock and buildings. A-20's bombed Longpre les Corps Saints, Abancourt, and Serqueux. The results of the A-20 attacks by 32, 7, and 25 aircraft are not known.

Other Operations of IX Fighter Command

After flying their assigned missions in the first assault phase the fighter-bombers continued active. In pursuance of the interdiction program the bridge at Oissel, under repair by the enemy, was twice attacked. In the first bombing by 31 aircraft 30.5 tons were dropped, while 36 tons were dropped by 47 aircraft in the second. The bridge remained standing, in spite of six direct hits after the first attack, but it was claimed that the northern half of the south span was in the river after the second.

Eleven missions were flown by fighter-bombers in response to eight Army requests submitted to headquarters by the Combined Control Center. Three of these missions were armed reconnaissance along the roads leading from Contanceux to Garenton, St. Lo, and La Haye du Puits. Railway targets and a highway bridge were bombed. A motor transport column was requested attacked. It was not found by the aircraft dispatched, which however strafed a train at Aircel. Similarly the request that another motor transport column northeast of St. Lo be attacked led to no action against the primary target, but targets of opportunity were hit. An urgent request for dive-bombing gun emplacements north of Isigny resulted in claims of hits in the target area. Other batteries shelling the beaches from the vicinity

[REDACTED]

[REDACTED]

of Carentan were attacked, and 12 direct hits were claimed on six gun emplacements, with three other like targets claimed destroyed. Scattered targets, including six gun positions, were hit between Isigny and Bayeux. The reported site of a heavy gun near Fontenay was bombed with supposedly good results. Batteries at Haisy which were firing on Utah beach were also hit by dive bombers. The call for an artillery adjustment mission was answered.

Thus out of a total of 13 requests for air-ground cooperation submitted at advanced headquarters, eight were accepted and acted upon. One was refused on the ground that no aircraft were available. Weather and the lateness of the hour led to no action in three instances, while in another case the request was held up, pending a report on a mission which was in the air at the time it was submitted.

It should be noted that the experience of D-day led to a slight but significant change in the plan for fighter direction. It was found that there was need for a number of squadrons to be available on short notice for missions against targets of opportunity and for armed reconnaissance at the direction of the Senior Air Representative for Force "O" on board U.S.S. Angan. The procedure of laying on such missions through Advanced Headquarters AAF and the Combined Control Center had proved slow. Accordingly, at fixed intervals squadrons were made available to the Senior Air Representative for use against targets of opportunity and for armed reconnaissance behind the enemy's lines. Such targets were reported to the Senior Air Representative by the Air Support Party on shore or determined by reconnaissance whose

[REDACTED]



reports were intercepted by the Ancon. Since U.S.S. Earfield occasionally experienced difficulty in communicating with fighters but could usually contact the Ancon, whose facilities were good, the Senior Air Representative for Force "U" occasionally made use of the Ancon's facilities in laying on missions in support of that force.

Ninth Air Force Total Effort on D-day

The full effort of the Ninth Air Force on D-day appears in the following summary:²

<u>Medium Bombers</u>	<u>Dis-</u> <u>patched</u>	<u>Attac-</u> <u>ing</u>	<u>Tons on</u> <u>Target</u>	<u>Missing in</u> <u>Action</u>
Medium-altitude visual bombing	1,005	817	1,435.605	11
Pathfinders	<u>6</u>	<u>6</u>	<u>6.00</u>	<u>—</u>
Total	1,011	823	1,441.605	11
<u>Lighter-bombers</u>				
Assault area cover	1,016	976		
Troop carrier escort	314	497		
Dive bombing escort	32	32		
Dive bombing	<u>577</u>	<u>562</u>	<u>336.16</u>	<u>9</u>
Total	2,139	2,065	336.16	9
<u>Troop Carrier</u>				
Glider tugs	104	103		2
Troop carriers	821	805		21
Gliders	<u>104</u>	<u>104</u>	<u>—</u>	<u>104</u>
Total	1,029	1,012		127
<u>Reconnaissance</u>				
Photo reconnaissance	80	52		
Visual reconnaissance	89	67		2
Weather reconnaissance	14	14		
Artillery liaison	2	2		
Photo reconnaissance escort	<u>7</u>	<u>7</u>	<u>—</u>	<u>—</u>
Total	192	162		2
Grand Total	4,371	4,062	1,827.765	149



Road Bridges. Ninth Air Force attacks on road bridges over the Seine produced equally good results. Those nearest Paris at St. Germain and Maisons Lafitte were not attacked. The bridge at Bennecourt was attacked twice by fighter-bombers and once by mediums. A medium attack led to the destruction of one span and the remainder were destroyed by the last dive-bombing mission of 3 June. Courcelles was first attacked by mediums which caused one span to sag. Two attacks by fighter-bombers and another by two groups of mediums led to the destruction of three spans as reported 3 June. A single dive bombing broke the bridge at Conflans, while two similar attacks on 30 May rendered that at Elbocuf impassible. Single missions by mediums in two-group strength broke two spans of the road bridges at Lantes-Cassicourt and Vernon, and demolished eight and nine spans respectively of the bridges at Meulan and Poissy.

Half of the road bridge at Pont de l'Arche was destroyed by dive bombing, while a like mission against Langport caused the structure there to sag. Two road bridges at Rouen were the objectives of three fighter-bomber missions and of two medium attacks. Since these bridges had been given first priority on 27 May the mediums attacked with three groups on 30 May and with four on 31 May. By the latter date the East bridge had been rendered impassable. The West bridge suffered a similar fate as the result of dive bombings on 2, 3, and 4 June. Although dive-bombed twice on 30 May the structure at St. Pierre du Vauvray was reported standing. It was the only listed target of this type which remained intact between Conflans and Rouen (inclusive) when D-day came.⁴

Air-Ground Cooperation

Request Missions

As V Corps extended its original Omaha beachheads in the period 7 to 10 June, the Ninth Air Force frequently cooperated. Joint action was never more evident than on D plus 1. Late on 6 June the commanding general of V Corps requested "continuous fighter bomber support to search out and attack enemy artillery firing on [Omaha] beaches." In response IX Fighter Command directed that beginning at 0600 on 7 June and continuing until 2200, one of its squadrons should always be over targets in the Aure River-Sayeux-Airel area. The squadrons, furnished by 365th, 366th, and 369th Fighter Groups, were to remain in the area for 30 minutes, or to the limit of their endurance, and to give gun positions target priority "as they have taken heavy toll on beach Omaha." Pursuant to these orders, ~~333~~ ³³³ Squadron-strength missions were flown in the designated area on 7 June, 487 planes attacking targets of opportunity with 1,000-pound GP bombs and frag clusters. Highway and railway targets (including HI and rolling stock), together with those furnished by enemy concentrations and stores in the forests of Gerisy and Dalleroy, were those most frequently singled out for attack in the course of these missions. However, five gun positions, including one of 82-millimeter guns camouflaged under straw stacks, were discovered and bombed with unknown results.³ Fighter-bombers also attacked six bridges in the Carentan area on 7 June and another on the 8th. They reported that gyps were torn in three of the bridges

[REDACTED]

bombed on the 7th. On the following day tracks were cut which forced the rerouting of traffic.⁴ On 10 June mediums bombed concentrations in the Forêt de Carisy with unknown results. Suspected enemy headquarters were also attacked. The mediums missed the building at Littry (7 June), but hit those at St. Martin des Boscqs and Jurgues (10 June), while fighter-bombers partially destroyed a headquarter chateau southwest of Montreuil (7 June). The signal communications repeater station at St. Lo was so well hit on 13 June that the enemy abandoned its use.⁵

Nearby VII Corps was enlarging its Utah beachhead, and as it moved north against Montebourg and west through St. Sauveur le Vicomte to the coast at Burneville, air-ground cooperation was even more in evidence than in the Omaha area. Mediums struck at five military installations in the Cotentin region between 7 and 14 June, but the heavy concrete structures which constituted their targets at such points as La Penneville and Montfarville were not materially damaged even by 3,000-pound G2 bombs.

Fighter-bombers silenced a battery at Littry on 7 June and between that date and the 17th attacked some 18 gun positions in the northern Cotentin area with special emphasis on those in the Barfleur and Montebourg areas. Clear evidence is lacking of results obtained with the exception of the attacks on Quineville (7 June) and Crisbecq (10 June). In both of these cases ground forces reported excellent results.⁶ On 10 June fighter-bomber groups flew four request missions, one against strong points north of Montebourg, the others with some nine bridges in the Ericquebec-La Hage du Points area as their targets. All were

[REDACTED]

[REDACTED]

associated with the northward and westward advance of VII Corps. The strong points were hit with results reported good, and ground observers confirmed the destruction of two bridges, with possible damage to rails in their vicinity.⁷

Troop concentrations reported in the area from St. Lo to Barfleur and St. Saviour le Vicomte were attacked by fighter-bombers on five occasions between 10 and 18 June with unknown results.

Highway Bridges and Road Blocks

Highway targets appear frequently in the operational records of 7 to 18 June. Nearly all of the objectives lay north of the line Couterances-St. Lo-Lunay surOLON and in such proximity to the battle lines as to cause missions against them to fall into the category of joint air-ground operations. Fighter-bombers attacked them on occasion, either as specified targets or as those selected by the leaders of area missions. Incident to such attacks the incomplete reports for this period specify fighter-bomber claims of over 1,000 M2 and M4 tanks destroyed. But the mediums, which flew nearly 40 missions against highway targets in the nine days 7 to 15 June, played the more conspicuous role.

It was the intent of the mediums to disrupt enemy movements by the destruction of bridges and the establishment of road blocks. IX Bomber Command demolished the highway bridge at Vermon (8 June), destroyed another at St. Saviour le Vicomte (10 June), and claimed to have destroyed two more at Conde sur Noireau (15 June).⁸ Those

[REDACTED]

[REDACTED]

attached at Volognes (10 June), at Argentan (14, 15 June), and at Lessay (15 June) appear to have remained intact although buildings in the area were demolished. The results of the bombing of Glen bridge (8 June) were the same, although the Commanding General, 21st Army Group commended the attack then delivered.

To produce substantial road blocks the Germans as a rule attacked highway junctions within towns in the expectation that rubble from destroyed buildings would obstruct them. Such blocks were created in many instances; excellent examples are Irigny, attacked by two groups on 6 June, Volognes, bombed by single groups on 8, 10, and 12 June, Periers, hit by a single group on 8 June, Juncy sur Odon, attacked by one group on the 12th and by another on the 14th, and St. Sauveur la Vicomte, which experienced attack by one and one-half groups on 10 June and by a single group on the 13th. In all cases highway obstacles were created by debris from demolished buildings. However, later ground investigation indicated that the road net in the area listed was generally such as to permit the detour of road blocks, although at some possible inconvenience to enemy movements.⁹

Interdiction Program to Isolate the Battlefield

After D-day the Ninth Air Force was more than ever mindful of the requirement that a tactical air force should prevent the movement of hostile troops and supplies into the theater of operations or within the theater. In the course of actions preparatory to the invasion it had participated in attacks on enemy rail centers, and in the month

[REDACTED]

[REDACTED]

prior to the assault it had succeeded in destroying the rail bridges over the Seine from Conflans to Rouen. Had the enemy been in unrestricted control of the rail system of northern France he would have been able to outpace the Allied rate of build-up in the lodgment area once invasion took place.

With the invasion under way it was no longer necessary to observe secrecy in attacking vital rail points, and the "cover" plan had no longer to be maintained. With an enlarged and more obvious plan for rail interdiction than before, the Ninth Air Force devoted a considerable proportion of its resources to this program which was designed to isolate the battle-field and deny to the enemy the use of communications leading into it and existing within it. The program was built upon earlier accomplishments and was very closely related to the heavy attacks on rail bridges over the Seine.

The Plan

The destruction of the rail bridges over the Seine denied enemy access to the battle area from the east. It was desirable that access to it from the south be restricted by the destruction of rail bridges over the Loire from Orleans to the east. This task was assigned to and executed by other British and American air forces. Other assignments to the Ninth, together with the distances at which the targets lay from its bases, precluded its general participation in this feature of the rail interdiction program.

[REDACTED]

[REDACTED]

A gap, variously described as the Paris-Orleans or the Seine-Loire gap, existed between the two rivers. It too must be closed to rail traffic if the program were to be fully developed in the manner now greatly to be desired. In the region of the gap were some eight bridges of critical importance since they controlled all liner loading into the battle area. They were Mantou-leucocast, Cherisy, Nogent le Roi, Maintenon, Chartres (Orne), Chartres (Southeast), Oloyes, and Beaugency. In the list of such bridges as first compiled, that at Epervre appeared in place of the two at Maintenon and Nogent le Roi. The substitution of these two for Epervre was made because the embankments at Epervre could be so easily repaired. Eventually secondary points were to be attacked to supplement the blocking of the gap, prominent among them being Bourth, Epon, Meziere, and St. Emy sur Lore. This was the more necessary since it early became evident that only if all available through lines were blocked could the maximum effect of the program be realized.

It was desirable, however, not merely to destroy bridges over the Seine and the Loire and within the gap, but also to deny the enemy the use of communications within the area between them and the sea. Within that area, and controlling movement to the battle line, lay a number of "ladders" of communication running generally north and south. The westernmost of these ladders was that of Avranches-Sarthe-Meung; the easternmost that of Erreux-Chartres-Voves. For the purpose of determining actions against these lines of communication

[REDACTED]

each ladder was divided into a northern and a southern section. In all there came to be six northern sections and twelve southern as follows:

Northern Sections

1. Rennes-Dol.
2. Vitre-Fougères-St. Hilaire
3. La Chapelle-Magnanne-Domfront
4. La Hutte Colombières-Allenton-Argentan
5. Montagne-Laigle
6. Conde sur Eulze-La Loupe-Vernouil

Southern Sections

1. Ploernel-Dinan
2. Messac-Rennes
3. Chateaubriant-Vitry
4. Craon-Laval
5. Grez-Laval
6. Sablé-Gille le Guillaume
7. Lellans-Gille le Guillaume
8. Lellans-La Hutte Colombières
9. Lellans-Mamers
10. Beille-Nogent le Rotrou
11. Courtelain-Nogent le Rotrou
12. Courtelains-Brou

The program was elaborate because the rail network was intricate. Rail centers, bridges, rail lines, and rolling stock all constituted appropriate targets.¹⁰

In carrying out this general program of rail interdiction in the period 6 to 13 June 1944 the Fifth Air Force made full use of both its major weapons. The nature and results of the heavy medium and fighter-bomber missions which ensued are best displayed in summary form.

Attacks on Marshalling Yards

The Fifth Air Force attacked more than 20 different marshalling

[REDACTED]

yards or sidings between 7 and 18 June, no less than 10 being bombed on the first day of the period. A few of the targets such as Valognes and La Haye du Puits were proximate to the battle area of the time; all were related to rail lines in the interdiction zone. Reported results vary greatly. On 7 June fair results were reported at Mont Secret and Le Mans and possible damage at Ericourt; but most of the tracks were cut at Eiers and at Argentan, through traffic was blocked at Vire and Avranches, while at Valognes one line was damaged. The next day all lines were cut when the yard at St. Lo was destroyed. At Dretigny (12 June) concentrations fell in the target area but the through lines remained open. Two attacks (8, 15 June) struck Laval, the first probably blowing through traffic, the second destroying 13 locomotives and 30 cars, together with rails and buildings.¹¹ La Haye du Puits was also hit twice (7, 12 June) and severe damage inflicted to the marshalling yard.¹² Folligny, hit by mediums on 7 June and by fighter-bombers on 12 and 14 June, was later found to have had all tracks effectively broken by over 40 cuts. The mediums' bombing had also caught two troop trains in the yards, en route from Rennes to Coutances. Both were destroyed with credibly reported casualties of 300 killed and 800 wounded.¹³ Ground investigation also reported maximum effects at Rennes produced by medium attacks on 12 and 13 June in one- and two-group strength respectively, and by dive bombing on the 14th and 18th. It is of interest to observe that the last named attack was delivered by the fighter-bombers which escorted the B-29's. Together they put the yard out of action. The passenger station was

[REDACTED]

[REDACTED]

75 per cent demolished, and 50 per cent damage was inflicted on the freight station and shops. The turn-table was destroyed, and 12 locomotives out of 23, together with 150 out of 400 cars, damaged or destroyed.¹⁴ Nearly all of the medium attacks had been delivered by single groups. On occasion, as at Flers (7 June), La Haye du Puits (7, 12 June), Meridon (14 June), and Conde sur Noireau (15 June), some bomb concentrations struck business and residential areas with dire results.

In the same period fighter-bombers attacked marshalling yards on more than 15 occasions. Targets at Le Molay (7 June), Aired (7 June), Lisnes (7, 8 June), St. Sauveur le Vicomte (11 June), La Haye du Puits (15 June), and Sottevast (15 June) lay within the battle zone. Colligny (13, 14 June) and Granville (14 June) were proximate to it. Fontenay (7 June), Alencen (13 June), Chateaudun (14 June), Rennes (14, 18 June), Mayenne (15 June), and Fougeres (15 June) were farther removed, but still within the interdiction area. Pilots' reports are not particularly informing, but in two cases among those mentioned above ground observers recorded the effects of dive-bombing and strafing missions. At Lisnes (7, 8 June) the attacks stopped all rail traffic and destroyed the empty coaches of the Cherbourg-Laris express.¹⁵ At St. Sauveur le Vicomte (11 June) all tracks and through lines were cut, an ammunition train destroyed, and heavy damage done to rolling stock.¹⁶

The net results of these attacks on marshalling yards are difficult to assess. Notable damage was inflicted on rails, but traffic on

[REDACTED]

Broken down by types of aircraft the same figures present the

following record:

	Type	Dis-	Atta-	Tons on	Missing in
	<u>A/C</u>	<u>patched</u>	<u>cking</u>	<u>Target</u>	<u>Action</u>
Medium-altitude visual bombing	P-26	733	511	1,175.605	6
Pathfinder	B-26	6	6	6.00	-
Medium-altitude visual bombing	A-20	269	236	260.00	5
Assault area cover	P-23	207	203	-	-
Troop carrier escort	P-23	129	127		
Dive bombing	P-39	49	46	33.50	2
Photo reconnaissance	P-39	59	33		
Photo reconnaissance escort	P-39	7	7		
Photo reconnaissance (night)	P-39	1			
Assault area cover	P-47	909	773		
Troop carrier escort	P-47	238	231		
Dive bombing	P-47	481	457	307.16	7
Dive bombing (night)	P-47	47	47	45.50	
Dive bombing escort	P-47	32	32		
Troop carrier escort	P-51	97	89		
Visual reconnaissance	P-51	89	87		2
Photo reconnaissance	P-51	20	19		
Weather reconnaissance	P-51	14	14		
Artillery liaison	P-51	2	2		
Glider tug	C-47/E3	104	103		2
Troop carrier	C-47/E3	321	305		21
Troop carrier	C3-44	104	104		104
Totals		4,371	4,062	1,826.765	149

The Period 7 to 18 June 1944

On D-day American forces went ashore at Omaha and Utah beaches. Between that time and 18 June the original beachheads were in general improved and consolidated; while, in particular, American ground forces pushed through to the west coast of the Cotentin peninsula in the vicinity of Exneville. When these actions were completed a lodgment area on the continent had been secured, and one part of the Ninth Air Force invasion mission had been accomplished.

[REDACTED]

battle area by forcing the use of long road detours, and aggravated the maintenance problem for armor and motor vehicles which had to take to the roads. In addition, the destruction of bridges created temporary blocks behind which traffic piled up, thus affording admirable targets for fighter-bombers.

Fail Cutting and Felling Stock

Two groups of medium bombers were assigned the mission of cutting rails on the line St. Lubin-Laigle-Merlerault on 17 June, and their bomb patterns were reported to have fallen across the tracks. Aside from that one action, fighter-bombers had a monopoly of such attacks. The records of the period 7 to 18 June indicate that they flew at least 15 group missions and 15 squadron-strength missions with rail cutting as their primary specified task. In addition leaders of armed reconnaissance frequently included rails and rolling stock among the targets selected for attack in the course of their area missions. As a result even the incomplete list of claims for this period includes specific claims of at least 23 cuts effected and some 60 locomotives and 600 cars destroyed. The results reported for some individual missions are of interest. A train was claimed destroyed between Granville and Tiro on 7 June, and on the same day 10 ammunition cars spaced at intervals on the line north of Alencon were attacked. Photographs showed that at least two exploded, cutting the rails for a distance of 200 feet. One mission on 10 June left a 50-car train in flames at Avranches and damaged others at Villedieu. By such actions

[REDACTED]

the enemy was allowed only restricted use of the elaborate rail network west of the Seine and north of the Loire which had such conspicuous centers as Vire, Bernay, Laval, Le Mans, Nogent le Roi, Chartres, Alençon, Le Mans, and Evreux. The actions ranged over much of this area from Vire and Evreux in the north to Chateaufort, Sable sur Sille, and Chateaufort in the south; and from Fleury in the west to the Paris area in the east.

Such rail cutting, which supplemented the attacks on bridges, intensified all the results produced by bridge breaking. It aggravated the enemy's problems of repair and, through multiple cuts on many lines, rendered rail movement hazardous if not impossible.

Enemy Commentary

In mid-June 1944 Allied commanders could merely estimate the over-all results of the interdiction program. The enemy, however, knew them intimately as is shown by evidence derived from the "War Diary of the 7th German Army." As early as D plus 1 its entries begin to record the difficulties arising from our insistent attacks on transportation targets. Notations under the date of 11 June indicate that at that time many were in evidence. "Railway transportation is impossible because the trains are observed and attacked in short order." "Troop movements and all supply traffic by rail to the army and within the army sector must be considered as completely cut off." Entry after entry fits into the picture of an exceedingly vicious circle, the relationship of whose parts the enemy was at pains to explain. Damage to

railways forced "the conversion of the entire supply and transportation system to motor transport." This led to "an extreme strain on motorized shipping space which is only available to the army in very limited quantity." Such strain was increased by the "constant attack" of American air forces at the front and in rear areas which "has led to delays and unavoidable losses in vehicles." Not merely was the movement of personnel affected and "the calculations of the time needed for any movement" by them rendered hopelessly incorrect, but lack of rail transport caused armor units to wear out their machines in moving to the battle zone, while once they were committed to action their mobility was restricted "due to the lack of fuel and the unreliability of the ammunition supply."¹⁸ At a much later date Field Marshal von Rundstedt was to declare that the condition of the heavily bombed French roads and rail lines around D-Day--particularly those in the Furi. area--prevented him from bringing up troops to counterattack.¹⁹

Attacks on Tank Supplies

In an effort to accentuate the enemy's shortage of fuel and ammunition, dumps containing such supplies were attacked by mediums and fighter-bombers of the USAB Air Force from 7 to 18 June. Three such targets bombed by mediums lay in the Doufront-Marcen area: at Doufront itself (15, 16 June), in the Forêt d'Andaine (17, 15, 18 June), and in the Forêt d'Escurves (15 June). All three were also subjected to fighter-bomber attack (15 June). Mediums also struck dumps close to the battle area in the Forêt de Grimberg (8 June), at Vilevres (15 June), and at

Deix du Harast (16 June), and others further removed at La Loupe (17 June) and Conches (18 June). Fighter-bombers attacked dumps in the Cherbourg area (13, 16 June) and one near Vire (15 June). With the targets well located in forest areas it is not to be expected that immediate reports of results would be very enlightening, although fires and explosions followed one of the three media attacks on the Forêt d'Ardrine (13 June), and fighter-bombers reported a tremendous explosion in a dump southwest of Cherbourg (16 June). Some further evidence is furnished by ground observers' reports, but since these record the cumulative effect of the attacks in this and later periods their consideration is postponed.

Special Targets

A tactical air force is nothing if not versatile. While concentrating their attention on such obviously high priorities as air-ground cooperation, the interdiction program, and attacks on enemy stores, the aircraft of the Ninth on occasion performed special missions in this period. They strafed the power house at Vire (15 June) and dive-bombed radar installations at Cap Frehel and Pointe du Grouin (16 June) and one near St. Pierre Eglise (16 June). Mediums bombed three pilotless aircraft-launching sites (18 June) on STB, while fighter-bombers, returning to their bases in England, destroyed three "flying bombs" in the air on the same day.

The Period 19 to 30 June 1944

The Ground Situation

From the time when American troops reached the west coast of the

[REDACTED]

Cotentin peninsula (18 June) until the Cherbourg peninsula was fully in their hands (1 July), operations of the Ninth Air Force maintained the essential characteristics which they had displayed in the earlier period of the Battle of Normandy. Prominent among these was air-ground cooperation which was exhibited on a notable scale in the course of the movement against Cherbourg (22 to 30 June) and elsewhere to a lesser degree. Attacks on communications targets related to the interdiction program were almost continuous. Fuel dumps were subjected to further attacks, and on occasion enemy airfields were the targets chosen. All of these activities were related to the second feature of the Ninth Air Force invasion mission as defined in the Tactical Air Plan--"to support the armies of the First U. S. Army Group in the development of the lodgment on the continent. . . ."

In respect to air-ground cooperation it should be observed that two developments assumed notable proportions in the period 19 to 30 June 1944: first, the provision of new instruments for the direction and control of fighter-bombers of the Ninth Air Force, and second, the movement of fighter-bomber units to permanent bases on the continent which had been constructed by IX Engineer Command.

Air-Ground Cooperation

From 6 to 17 June direction of air-ground cooperation missions had been in the hands of Headquarters Ninth Air Force at Unbridge which functioned in close association with the Combined Control Center of 21st Army Group. Such direction was limited only by the control provided by the Senior Air Representative on board U.S.S. Arden from 6 to

[REDACTED]

~~TOP SECRET~~

10 June and by 70th Fighter Wing from 10 June forward. On 10 June, however, under General Order No. 153, Headquarters Ninth Air Force, IX TAC was charged with operational control of all fighter-bombers arriving on the continent. IX TAC was in a position to assume this responsibility since its first mobile operations echelon had arrived at Au Gay on the 9th and established IX TAC Headquarters there the following day in close proximity to Headquarters First U. S. Army (FUSA). On 13 June the newly established headquarters began to exercise operational control through 70th Fighter Wing, which had been set up at Criquetville 9 to 11 June. A further and more significant step in the provision of continental controls was taken at midnight 17-18 June when Headquarters IX TAC, in conjunction with FUSA, assumed responsibility for designating base lines and for operating the Air Support Net. It was to submit those requests which it could not meet with its own resources to Headquarters Ninth Air Force at Uxbridge. This action meant that as far as fighter-bombers were concerned, effective direction of Ninth Air Force air-ground cooperation was placed in the hands of IX TAC. It was to remain there until operational functions were redistributed after Headquarters Ninth Air Force itself became operational on the continent. Symbolic of their common interest and joint participation in current air-ground operations was the presence in IX Tactical Air Command's operations tent of G-3 Air and G-3 Air of FUSA and the intimate association of IX Tactical Air Command's A-3 and FUSA's G-3 sections.²⁰

~~TOP SECRET~~

Combat Units on Continental Bases

The movement of fighter-bomber units to permanent bases on the continent depended on the ability of IX Engineer Command to construct new airfields or to restore enemy fields to operational use. In turn, IX Engineer Command's ability to provide such bases depended upon the ability of the ground forces to capture the intended sites. In general the construction schedule drawn up prior to D-day was not fulfilled due to the simple fact that few of the airfield sites were in our possession at the time originally estimated. The achievement of the engineers in the month of June was nevertheless notable, as is indicated by the following table.

PROVISION OF CONTINENTAL AIRFIELDS, JUNE 1944

No.	Location	Constr.	Opn. as	Constr.	Used as	FB Co.
		Started June	ACG June	Completed June	Permanent Base June	
HS 1	Fouppesville	6	-	6	-	-
A-1	St. Pierre du Mont	8	20	21	20	368
2	Griquesville	10	16	-	23	354
3	Cardonville	10	23	23	19	368
4	Deux Jumeaux	14	26	30	23	42
5	Chippelle	16	-	-	-	-
6	Fouzeville	8	11	17	23	371
7	Asceville	16	20	-	29	365
8	Picourville	20	-	-	-	-
9	Le Molay	21	30	-	-	-
10	Carentan	15	20	30	25	50
14	Creteville	23	27	-	-	-
15	Mampertus	27	-	-	-	-

The initial Engineer detachments were speedily followed by others and reinforced by Ninth Air Force Quartermaster track companies, and although the work was somewhat heavier than expected, the rate of construction of advanced landing grounds was greater than that which had

been anticipated. On occasion, as at Fouppesville, St. Laurent, and Carleton, enemy ground opposition was encountered. Air attack was likewise experienced, although slit trenches prevented casualties from bombing and strafing. The greatest obstacle was dust arising from the silty and excessively dry soil. This impeded the construction work of the engineers and was later to cause maintenance problems to the air units in spite of the use of straw or Hessian under square steel-track matting.

In spite of all obstacles IX Engineer Command began construction in June of 12 airfields which were to be used as permanent bases by fighter-bombers. Even prior to the completion of full operational facilities on them, many fields were used for crash landings, supply and evacuation, administrative traffic, and most notably, for reulapant by fighter-bomber units operating from English bases. By the end of the month nine airfields were reported operational as HQ's. As early as 13 June air units based on Britain began their operational use, and on 19 June the first operational use was made of an airfield (Cardonville) by fighter-bombers permanently based there. By the end of the month, as shown by the above table, no less than seven fighter-bomber groups were operating from newly built airfields on the continent. The efficiency of the fighter-bombers was greatly enhanced by their ability to use continental fields for reulapant and, more particularly, as permanent bases. Furthermore IX Tactical Air Command had a constantly increasing number of aircraft immediately available for its use in air-ground cooperation. ³³

The story of such action in the operations against Cherbourg is of such significance that it must be accorded first place in the operational narrative of this period and must be presented in full detail. The narrative of other actions of the same type in the latter part of June may be postponed for later and less summary treatment.

The Cherbourg Campaign, 22 to 23 June 1944

The Plan for the Initial Operation

The plan for air-ground cooperation in the projected attack which had Cherbourg as its final objective began to take form in a morning conference at VII Corps Headquarters on 21 June 1944. General Brereton (Ninth Air Force), Casada (IX AF), and Collins (VII Corps) were present.

The attack, with the 9th and the 79th Division participating, was to be launched on 22 June and had the high ground overlooking the city and the port as its immediate objective. General Collins indicated that he could mount it as late as 1600 to 1700 if early weather conditions were not propitious for the air assault. It was held that the enemy was disorganized and it was believed that a heavy air attack immediately preceding the ground attack would greatly facilitate the advance of the VII Corps by reducing the strength of enemy batteries and strong points along the lines of advance. Generals Brereton and Casada were ready to employ all available Ninth Air Force bombers and fighter-bomber in the delivery of the air attack.

Circumstances demanded that the air plan be rushed through its later stages. Further conferences with Generals Bradley, Spotts, and Vandenberg, Air Marshal Conington, and Air Vice Marshal Greene followed in swift succession on the continent and in Britain. In the final stages no USA representatives were present. The completed plan, flown to the continent in the early morning hours of 22 June, called for a very closely coordinated attack on that same day.

The area included within the coordinates O-167524, O-167163, O-108163, O-91134, O-068232, O-053213, O-003214, and O-144334 was marked out for the general air attack, with certain localities within it assigned priorities. The south and southwest boundaries of the attack area were to be marked by white smoke laid down by artillery. Before H minus 80, U. S. artillery was to engage in counter battery fire upon enemy fire positions. Between H minus 80 and H minus 71, four squadrons of rocket-firing typhoons from 21 Tactical Air Force were to strafe the northern half of the attack area, giving particular attention to fire positions. Six squadrons of 21 Tactical Air Force Mustangs were to follow and ground-straft the attack area from H minus 70 to H minus 61. No bombs were to be dropped by 21 Tactical Air Force units.

11th Air Force fighter-bombers were to come into action at H minus 60. From that hour until H minus 5 minutes, 13 groups were to attack from west to east at five-minute intervals. P-51's and F-51's were to carry two 500-pound and P-47's three 500-pound GP bombs. They were to bomb and strafe military installations, troops, and transport

[REDACTED]

in the attack area and give special attention to six pin-pointed localities.

At H-hour, fixed at 1400, the ground forces were to begin their assault as Ninth Air Force medium bombers began delivering a series of attacks designed to form an aerial barrage moving northward in anticipation of the ground forces. All 11 groups of IX Bomber Command were to participate and to bomb 11 different pin-pointed localities. Three of these coincided with localities singled out for special attention by fighter-bombers. Two groups were to carry 50 x 100-pound frags, seven were to be loaded with eight 500-pound and two with six 500-pound GP bombs. Nine targets were, according to the final order, to be bombed visually, the balance on PNT. The attacks were to be delivered at intervals ranging from two and one-half to 10 minutes.

Taken as a whole, the plan involved the first large-scale and closely coordinated air-ground attack since D-day.

Air Striker, 20 June

Fighters. The air strikes proceeded as planned. The attack by 2d Tactical Air Force aircraft covered the period between 1810 and 1800 hours. Between 1802 and 1805 some 507 Ninth Air Force fighter-bombers were over the target area. They strafed ground targets and, employing dive-, glide-, and slip-bombing techniques, dropped a total of 500.5 tons of bombs. Only one group sighted enemy aircraft--which, however, refused encounter. Twenty-four fighter-bombers were lost in attacks

[REDACTED]

[REDACTED]

which carried them down to 200 feet. At Octeville the marshalling yard and adjacent tracks were heavily hit; a single 50-foot crater, estimated to require 500 yards of earth for filling, completely destroyed 200 feet of rail line.²⁰⁸ Precise results of other attacks are impossible to assess. Some direct hits were made on gun or machine gun emplacements, seven of which were claimed to have been neutralized. A fuel dump was hit and exploded. In addition a radio station, two flash towers, and 20 buildings were claimed destroyed. It should be borne in mind, on the one hand, that General Collins thoroughly understood that no great material damage could be expected, and on the other that the demoralizing effect upon troops, already disorganized in some degree, was very great. Prisoner of war statements, even when taken with reservation, indicate that low-level fighter-bomber attacks produced a psychological effect far greater than the actual destruction or casualties caused, and one which on occasion made it impossible for officers to hold their formations together. Such psychological shock passes, and can only advantage attacking troops if they attack immediately after the fighter-bombers have delivered their assault. Some confusion was caused in marking the target area with smoke shells which are difficult to distinguish from other bursts, friendly or enemy. Their efficiency was further reduced by the dust and smoke produced by the first air attacks. Three instances occurred of attacks by small numbers of friendly aircraft upon our own troops, with little damage reported.

[REDACTED]

~~SECRET~~

Attack by medium bombers upon 11 defended localities were delivered between 1101 and 1455. Approximately 300 planes were dispatched, 13 carrying windows. Of these some 375 attacked, dropping a total of over 500 tons of bombs. Available evidence suggests that the material damage to the designated targets was small. Four localities were well hit; and in these cases where precise off-air could be determined, gun positions, barracks, tank traps, and the defense systems were found to have suffered. In one instance (O-111214) later ground investigation disclosed that heavy damage was done to guns, to the fire control center, and to personnel. There was no evidence of damage to the targets in the remaining seven group attacks. In four instances results were negative or undetermined. In three cases the bombs fell off the targets but damaged roads, buildings, and gun emplacements in other areas.

Only a small portion of the area marked out for air attack was occupied by friendly troops up to 0600 on 23 June. However, this included valuable high ground in the vicinity of Cherver. This was an area to which both medium and fighter-bombers had devoted special attention on the 22d, and it was to serve as the base for further penetration of enemy positions south of Chartoung on the following day. Not until 23 June was the air-attack area largely overrun.

Nevertheless, division commanders and the corps commander concerned expressed themselves as well satisfied with air-ground cooperation on 22 June. Headquarters Fifth Air Force felt that the operation was justified, although inclined to believe that the attack upon

~~SECRET~~

~~CONFIDENTIAL~~

selected pin-point targets by medium bombers night well have preceded the air strikes by fighter-bombers whose attacks immediately in front of friendly troops would assist their steady and uninterrupted advance.

These operations of 22 June had not been without cost to the Ninth Air Force, as is shown by the following table:

<u>Type</u>	<u>Destroyed</u>	<u>Det. "B"</u>	<u>Det. "C"</u>	<u>Det. "A"</u>	<u>Det. "D"</u>
Bomber	1	1	3	0	07
Fighter	<u>24</u>	<u>4</u>	<u>0</u>	<u>0</u>	<u>51</u>
Total	25	5	3	8	131

Operations, 23 to 20 June

During the balance of the action which led to the reduction of Cherbourg and the occupation of the peninsula, the Ninth Air Force continued its air strikes in cooperation with the ground forces. On 23 June two groups of fighter-bombers attacked strong points in the battle area with results reported as good and excellent. The following day saw a larger-scale effort. Four groups of mediums were assigned four targets consisting of gun batteries and strong points in the immediate vicinity of the port. Among them was Fort du Foule. They attacked with 2,000-pound CP bombs, and in all cases the bulk of their loads fell within the target areas in a fashion which warranted assessment of destruction or damage to casemates or gun positions in three instances. Ground force officers cited these attacks as particularly good examples of air-ground cooperation resulting in quick movement by the infantry with comparatively little trouble. On the

~~CONFIDENTIAL~~

~~CONFIDENTIAL~~

107

same day fighter-bombers delivered attacks against seven other strong points. All were successful, that by two squadrons on La Mare es Comards (0-152199) offering a remarkable example of air-ground cooperation since 18 direct hits on the encircled position assisted the infantry in occupying their objective.^{25b} Another attack on a strong point east of Cherbourg was later found to have been exceedingly well hit. It had contained seven guns of various types and calibers. A 75-millimeter field gun had been destroyed and two 89-millimeter M1 guns had been damaged, although a hit 75 feet from an 89-millimeter gun produced no damage.²⁵

On 25 June three squadrons of fighter-bombers attacked similar targets west and southwest of the city in a manner which won the approval of ground force officers. Again on 27 June two squadrons of fighter-bombers attacked batteries to the west of Cherbourg and in the Cap de la Hague region. Their claim of two batteries destroyed and two damaged were later verified.²⁶ On 29 June three fighter-bomber squadrons gave their attention to batteries near Cap de la Hague, while another bombed Fort Central on the Cherbourg breakwater. This fort had held out against heavy artillery fire, but immediately after the air attack it ran up the white flag. The bombs had done little physical damage to the fort's massive granite construction, but prisoners were unanimous in their statement that dive bombing rather than the fire of 155's caused their surrender. On this same day (29 June) three groups of mediums bombarded heavily defended positions in

~~CONFIDENTIAL~~

[REDACTED]

the Cap de la Hague region. No hits were registered on those at La Pel or Martins and Digulleville. At Auderville and Lye the heavy guns were themselves undamaged, but their operation was largely neutralized by direct hits on emplacements, traversing rings, and tracks leading to the ammunition storage area. Explosions were caused by the bombs falling on Lye.

Organized resistance within Cherbourg itself ceased on 27 June, and the peninsula was fully in our possession by 1 July. Air-ground cooperation by the Fifth Air Force, whether on a large scale, as on 22 June, or on a small scale, as in the attacks of 23 to 29 June, had assisted in producing this result.²⁵

Other Air-Ground Cooperation Activities

With the exception of the actions against Cherbourg (22 to 29 June) air-ground cooperation appeared on a limited scale between 19 and 29 June. On the 20th, however, three fighter-bomber missions were flown against enemy gun positions in the vicinity of Barfleur, Cherbourg, and La Pernelle. In only one case are results certain. Enemy ground observers found that while the gun positions at Termanville were not hit, the concrete buildings housing personnel had been destroyed.²⁶ Gun positions in the St. Is area were also attacked by fighter-bombers on the 21th, 27th, and 29th, while on the 29th similar targets on Alderney and at Granville were dive-bombed. On 25 June a tank and motor park south of Carantun was struck. Such missions are, however, to be rated as incidental. At the end of the month, as ground forces

[REDACTED]

[REDACTED]

began to move south against limited objectives, there was a rather greater concentration of effort. In this connection six request missions were directed against enemy positions in the Villodieu, La Haye du Puits, and Lessey areas on 29 July, followed by another on the 30th. Pilots reported hits or the neutralization of the targets in all cases. In the case of one attack of the 39th, which had two gun positions assigned as targets, the ground forces reported that the dive-bombing attacks had kept the enemy's observation posts from operating. As Fifth Air Force planes approached, the enemy ducked into fox holes and remained there while they were in the vicinity, while heavy gunfire ceased after the dive bombing. Such results of air action enabled our troops to take positions south of St. Sauveur la Plaine without too much interference. This testimony by ground was of peculiar value since scattered markers on the hilltop targets were the only material evidence available to supplement the flyers' claims.²⁷

Attacks on highway targets on 30 June were related to the ground forces' thrust against Caen. Mediums attacked road junctions at Elmy, Harcourt and Conde sur Noireau with two groups each, but with indefinite results. Dive bombers claimed good results on road at Amay sur Cdon and Jurgues. Hits were scored by the mediums which attacked the coastal battery at Houlgate (29 June) and a reputed headquarters at Saxon (27 June), but none resulted from a fighter-bomber attack on another headquarters (29 June).

[REDACTED]

[REDACTED]

through lines was in most instances interrupted for only a short space of time. Nor can it be claimed that injury done to rolling stock reduced the number of locomotives and cars below the enemy's essential requirements.

Attacks on Bridges.

In the development of interdiction in this period, three Seine bridges in close proximity to Paris, together with six bridges or embankments in the Paris-Orleans gap, were subjected to a total of 12 attacks by IX Bomber Command. Only at Chartres (15 June), where traffic was blocked, was any considerable success achieved by the group attacks. Within the interdiction zone the medians bombed six similar targets in the course of nine attacks. At Lessay, attacked by one group on the 7th and by two on the 8th, the embankment was damaged. A first attack on Pontaubault (8 June) only damaged the embankment, but on the 11th a span was brought down.¹⁷ The center span of the Coutances viaduct fell under the attack of 10 June, and two spans of a similar structure at Laval were demolished on the 16th. The most significant of the fighter-bomber attacks on bridges associated with the interdiction program were those directed against the Seine bridge at Orléans which was reported destroyed by attacks on 7 and 8 June. They delivered many attacks on minor bridges in the course of their missions and claimed the destruction of at least 10.

The air attack on bridges imposed a maximum of delay on the movement of German forces and supplies, increased the fuel shortage in the

[REDACTED]

Interdiction Program

Marshalling Yards

IX Bomber Command devoted much of its attention to the interdiction program of fighter-bombers under the control of IX Tactical Air Command and IX Fighter Command. Marshalling yards were frequent targets. On four different days, the medium bomber force hit a total of six separate targets. At Hazebrouck (24 June), Valenciennes (18, 23 June), and Bourges (27 June) there was no evidence of any considerable damage done. Bomb concentrations fell in the yards at Valenciennes (22 June) and Bourges (24 June), but in each case damage was done also to business and residential areas. The bombing of the yard at St. Quentin (22 June) hit all east and west tracks.

Fighter-bombers were assigned to, or themselves selected, 29 different marshalling yard targets between 19 and 30 July. They ranged over a wide area from Granville to Lyon, and from Orleans to Evreux and St. Quentin, and the attacks on them varied greatly in strength and results. Outstanding results accrued in some instances. Five hits at Chantilly (20 June) produced a large explosion and flames. Fires likewise followed the attacks at Granville (20 June), La Loupe (21 June), and Chartres (25, 29 June). Four trains of eight cars each were claimed destroyed at Gisors (22 June), cars exploded and were left burning at Soissons (27 June), and a total of 50 cars were claimed destroyed in the four yards of Clermont, Lyon, Compiègne, and St. Quentin (21 June). Pilots reported heavy damage at Evreux (21 June) which was confirmed by later ground investigation. However, the ground

[REDACTED]

observers also discovered that the Germans had a large repair crew available, and by using alternative sidings and switches, restored through traffic in a day's time.²⁸

Rail Cutting and Rolling Stock

The cutting of rail lines and the destruction of rolling stock were continued in this period. On a single occasion (30 June) one group of mediums was assigned to cut rails between Dol and Rennes and another, those between St. Hilaire and Vitre. The results of their attacks, made on short runs out of clouds, were indefinite. Inevitably the bulk of these tasks was assumed by the fighter-bombers which attacked rails and rolling stock with an almost monotonous regularity in the course of area sweeps or on missions where such targets were specifically assigned. Reports of these many missions often fail to detail their claims, but those which are specified afford a picture of the approximate results of these operations. Eighty-nine rail cuts were claimed. In addition, excluding all indefinite reports and all claims of rolling stock probably destroyed or merely damaged, fighter-bomber pilots reported a minimum of over 50 locomotives and more than 900 cars destroyed. Incident to these same operations against railway targets pilots submitted claims of more than 250 ME and some 15 tanks destroyed.

Where unusual targets were found, the results of individual missions were striking. A direct hit on an ammunition train (21 June) blew up four others of about 25 cars each on the line Paris-Chartres-Nogent. A train loaded with tanks was strafed and damaged (23 June); an attack directed against tanks on trains near Nantes

[REDACTED]

Gasricourt (21 June) achieved notable success. Locomotives, cars, and tanks were hit by direct attack and the firing of the tank cars which formed part of the trains completed the work of destruction. In the same area and on the same day a locomotive and 30 flat cars carrying 10 tanks and as many 15 were strafed and claimed destroyed. When a stationary line of freight cars was found near La Ferté St. Aubin (21 June) 200 tank cars as a result of strafing. Some cars burst into flame after 100 had been strafed between May and Vitry (20 June), while another mission (27 June), which claimed the destruction of four locomotives and 74 cars, left the roundhouse at Chateaugiron in flames. Two tunnels were dive-bombed on 23 June and pilots reported the destruction of both. Ground observers, however, later found that in one case (E-5105) the bombs missed the target, while in the other (E-2928) the objective was demolished.²³ A hit on top of the tunnel near its western entrance caused a cave-in, while other hits over the tunnel produced cracks in the masonry arches which resulted in leaks and a general weakening of the structure.²³

Bridges

Key bridges over the Seine or in the region of the Paris-Orleans line afforded targets for both mediums and fighter-bombers in the second half of June. Those which had not been broken earlier required action. Those which had been effectively hit earlier were being repaired by German engineers and demanded further attention. The mediums attacked five, each in group strength. Two spans of a

Antiaircraft defenses of marshalling yards and bridges, notably of those over the Seine, had been increased throughout the month and account for the heavier losses and battle damage experienced in attacks on such targets.³³

The over-all results of interdiction were in line with those earlier noted, but since the program was to be continued intensively throughout July, their full consideration is deferred until the end of that month.

Bumpy Supplies

IX Bomber Command struck at seven different fuel dumps in the period 19 to 30 June. An attack by three groups on ammunition stores in the Forêt de Senonches (25 June) resulted in large-scale explosions, subsequently confirmed.³⁴ The Forêt d'Andaine was bombed on the 22d and 23d by two and three groups respectively. Fires of flame followed one attack (25 June), but the majority of the bombs dropped on the 22d fell in the target area. The dump in the Forêt de Conches was likewise attacked three times (22, 24, 29 June) and that at Baguelles de l'Orne twice (22, 24 June), single groups attacking in each case. Erus, the Forêt d'Esourves, and Conde sur Vire were the objectives of one mission each on 24, 25, and 29 June respectively. Reasonably effective bombing of the target area was reported in most of these cases. Fighter-bombers attacked similar targets on two occasions. No results were observed in the attack on St. Sever (19 June), and no explosions followed the direct hit scored on Chabrier (25 June).

[REDACTED]

Enemy Airfields

On 21, 22, and 23 June fighter-bombers were directed against one or more enemy airfields. The attack on St. Andre de l'Eure (22 June) produced no substantial results. At Chartres (21 June) dispersal areas suffered damage, while a total of four planes were destroyed on three fields near Dreuil (23 June). Hits were scored on the runway at Greil and an explosion produced (22 June), while concentrated hits on the hangars at Peronne were followed by a large explosion.

[REDACTED]



Chapter IV

OPERATIONS IN JULY 1944

Air-Ground Cooperation

Relationship to Ground Operations

Throughout the month of July the Ninth Air Force continued its active cooperation with the ground forces. Fighter-bombers still maintained their patrol over the assault areas and furnished escort to IX Bomber Command, but air-ground cooperation was one of their two major activities. IX Tactical Air Command, with its headquarters and many of its groups on the continent, devoted the bulk of the aircraft under its operational control to missions closely coordinated with the ground effort of FUSA. Only on infrequent occasions did it share in the interdiction program. On the other hand, the headquarters of IX Fighter Command continued at Uxbridge, and the aircraft under its control coordinated their efforts with that of the Allied ground forces only in exceptional cases. Interdiction engrossed the attention of IX Fighter Command and called for the employment of nearly all of its available strength. The same was true of IX Bomber Command. Nevertheless, a complete picture of air-ground cooperation on the part of the Ninth Air Force demands a consideration of the work of all three of the commands above mentioned.

The narrative of such operations can well be divided into three parts. The first embraces the period 1 to 24 July when the ground



forces were regrouping, reorganizing, and seeking positions from Caen to the west of the Cotentin which would favor their major assault. The second involves the dramatic contribution of air power to the break-through west of St. Lo on 25 July. The third must concern itself with air's share in the full exploitation of that initial victory during the rush south to Avranches and beyond.

The Period 1 to 24 July

IX Tactical Air Command

In the period 1 to 24 July, as throughout the month, IX TAC made its most substantial contribution by way of air strikes coordinated with ground effort. Characteristic of its many air-ground cooperation targets in these days were enemy strong points, troop concentrations, headquarters, and command and observation posts. Three strong points east of La Haye du Puits were attacked on 2 July with good results, a violent explosion resulting in one. Explosions likewise occurred when three positions occupied by dug-in tanks, MG's, or artillery in the St. Lo-Periers area were subjected to as many fighter-bomber attacks on 23 July. On 6, 8, and 23 July targets furnished by troop concentrations were well hit southwest of Carentan, near Beny Bocage, and close to Periers. An attack on a reputed headquarters at St. Germain sur Ay demolished a building on 2 July. A church tower, used as an observation post southwest of Carentan, was destroyed by the second of two attacks the following day, while buildings housing command posts in the Periers area were smashed by dive bombings on the 5th and 8th.

Although related to the interdiction program, attacks by IX TAC on bridges in the Vire valley, south of enemy positions at St. Lo, are properly classified as air-ground cooperation missions. Eight such attacks were delivered in squadron strength on 16 July. Two bridges were destroyed or rendered unserviceable, while direct hits were scored on two others. On the following day 17 bridges over the Vire and the Sienne were listed for attack. Two were made unserviceable and others damaged in varying degree. On the eve of the great assault (24 July) two other bridges in the same area were attacked with inconclusive results.

An interesting commentary on the air strikes of IX TAC is afforded by the letter of commendation written on 20 July by Maj. Gen. Charles H. Corlett, Commanding General, XIX Corps. On the 16th IX TAC had flown four missions at the specific request of XIX Corps and on the 17th six more. General Corlett expressed his thanks for the cooperation thus afforded his troops in the fight for St. Lo. He declared that air strikes arrived on time and on the target and added that they had broken up an enemy counterattack on the afternoon of 17 July. In conclusion he stated that "The presence of our aircraft over the front line troops has had an immeasurable effect upon their morale. When our aircraft are over the front line the use of close in artillery and mortars by the enemy stops."¹

IX Fighter Command flew air-ground cooperation missions on only five different days from 1 to 24 July. On four days such missions were coordinated with the ground force movements west of Carentan. On the

3d five missions, ranging in strength from group to squadron, were flown against gun positions and defended localities in the Lessay-Periers area. Bombs fell in all the target areas, but the results were unobserved. The next day troop concentrations were bombed with unobserved results in the Lessay, La Haye du Puits, and St. Sauveur le Vicomte areas. Weather prevented most of the aircraft assigned to bomb gun positions in the bottleneck along the Carentan-Periers road from executing their missions on 10 July. The attacks were repeated on the 11th when gun positions southeast of Lessay and at Creances were reported neutralized and an ammunition dump destroyed. On that same day squadrons of 366th Fighter-Bomber Group, operating in the rain with a 1,000-foot ceiling, struck at tanks close to friendly lines in the vicinity of St. Lo. Three consecutive missions spoiled an enemy counterattack.² Six groups were assigned targets in the St. Lo area on 24 July, but weather forced the recall of three. The balance bombed the target area with results unobserved.

IX Bomber Command

In this same period IX Bomber Command frequently coordinated missions with FUSA and British 21st Army Group. As American troops moved down the Cotentin peninsula they were expected to reach points on the coast near Lessay by the evening of 4 July. In conjunction with this effort a group of mediums attacked each of the defended localities at La Moriniere and La Barberie with unknown results. Later, as a preliminary to projected ground operations, two groups were given three

enemy positions for attack in the St. Lo area on 15 July. As was frequent in this period, the attacks could not be carried through. Rescheduled the following day, the targets were attacked by two full groups. Some 25 craters were produced in one position, but little damage was done to the others.

IX Bomber Command laid on several missions from 5 to 8 July, all designed to assist 21st Army Group in its advance into Caen and beyond. A first attack (5 July) by a single group on two Caen bridges did not achieve their destruction, but both were rendered unserviceable by a repeat mission on the ensuing day. No less than seven groups were dispatched on 7 July against enemy troop concentrations in woods near Ussy, but only one group and part of another could attack. Fires followed their bombing, but other results were indefinite. On the following day, as the British developed their full-scale attack in the Caen area, five targets (strong points or bridges) were set up for attack by mediums. The results of the bombings by two full groups and parts of two others were not ascertained.

Further coordination with the British was evident on 18 July when 21st Army Group sought to consolidate its positions between Caen and Falaise. In cooperation all 11 groups of IX Bomber Command attacked a total of five gun positions in the Demouville-Giberville area, eight B-26 groups using 260-pound frags and three A-20 groups dropping 500-pound GP's. Again, results were indefinite or unobserved.

Weather, generally adverse from 1 to 24 July, rendered many of IX Bomber Command's air strikes abortive or caused them to be made with less strength than planned. It likewise made its contribution to the difficulties in determining the results of attacks delivered.

Evaluation of Air-Ground Cooperation

The commentary of the "War Diary of the 7th German Army" on the air activities chronicled above is brief but full of interest. It asserts on 1 July that "The enemy is conducting a thorough air reconnaissance both day and night, before and during the attacks. His artillery fire is directed by numerous artillery observation planes. Troop concentrations, movements and supply traffic are being bombed and strafed and, with some measure of losses, badly disrupted." With reference to our attacks being pressed in the La Haye du Puits area on the 4th it observes that "the enemy air force has made any movement by us impossible." On 7 July, while insisting that the fighting of the 84th Corps was "a considerable defensive achievement," it makes a remarkable admission: "the situation here must be viewed as particularly critical for the enemy artillery fire and the continual air attacks against our troops are causing heavy losses in men and materiel, and sooner or later the time will come when the steady decrease in manpower will make our positions untenable. So far our own fighter planes and antiaircraft artillery have not been able to ease the pressure." The next day the statement of 1 July is repeated, almost verbatim. Admission is made on the 15th that during the previous week air attacks had been unusually strong, with heavy casualties resulting

from fighter-bomber actions. Finally, on the 17th, following two days of IX TAC missions against bridges in the Vire valley, the German record states, "the destruction of all Vire bridges west and south of St. Lo threatens to cut off the 352nd Inf. Div. and to make it impossible to move the heavy weapons in time." A withdrawal was therefore planned and executed that same night. Such observations constitute an excellent gauge of the efficacy of Ninth Air Force air-ground cooperation in the first 24 days of July 1944.³

Further evidence as to the effective role of air power in the invasion of Europe is found in letters of Allied commanders. Sir Bernard L. Montgomery, General Commander in Chief of the Allied Armies in France, declared,⁴

We soldiers know very well that if the Allied air forces had not been able to dominate the Luftwaffe, then the armies could have achieved little. You did dominate the Luftwaffe, and you continue to do so, and we know that this state of affairs will continue to the end--of that we are certain. We know that much of your effort is best applied far afield; but we also know that in our hour of need you are always very ready to apply the whole might of your power to help us in the tactical battle in Normandy.

To this Sir Trafford Leigh-Mallory, Air Commander in Chief of the Allied Expeditionary Air Force, added,

I would like to take this opportunity of expressing my thanks to the Ninth Air Force for the enthusiasm and efficiency with which they have carried out the innumerable tasks assigned to them both during the preparatory phase and since the battle has started. They have already made a tremendous contribution to the winning of the battle of Normandy. . . ."

Operation COBRA, 25 July

The focal point in the story of air-ground cooperation in July is

[REDACTED]

found in Operation COBRA--the closely coordinated air-ground effort, designed to break through the enemy's positions west of St. Lo--which was delivered on 25 July 1944. It had been planned originally for 21 July, but weather on that and the two following days had caused its postponement. On the 24th the Eighth Air Force inaugurated the air phase of the attack, but weather closed in and prevented further operations. On 25 July, however, the air strikes were executed essentially as planned, and the ground forces began their advance.

H-hour had been set at 1100. Between 0938 and 0957 eight groups of Ninth Air Force fighter-bombers delivered a first bombing and strafing attack from low level against an area some 7,000 yards long and 250 yards wide, just south of the St. Lo-Periers road. The aircraft flew to their initial point over site A-10, checked with the Controller there, and then flew directly to St. Lo, where they made an approximate 90 degree right turn to their target. The target area had been divided into an eastern and a western area, the diving line as well as the extremities being marked with red smoke. The first of the assaulting groups attacked the eastern area, the second the western, and so on in alternation at three-minute intervals.

Over 1,500 Eighth Air Force heavy bombers delivered an attack between 1000 and 1100 upon a large area destined for ground assault.

At 1100 seven groups of Ninth Air Force fighter-bombers resumed their low-level assaults upon the area marked out for their attack and continued them until 1118.

[REDACTED]

[REDACTED]

All 11 groups of IX Bomber Command's mediums then joined the assault. Three groups of Bostons concentrated their attacks upon the St. Gilles area, while eight Marauder groups bombed pin-pointed and area targets in the vicinity of St. Lo, Hebecrevon, La Chapelle en Jager, and Montreuil. The planes bombed between the hours of 1132 and 1223.

Area cover was provided by VIII Fighter Command, while P-51's of the Ninth Air Force flew deep defensive sweeps in support of the air operations.

All available Ninth Air Force fighter-bombers had participated in the two attacks upon the area just south of the St. Lo-Perliers road. The weight of their effort is indicated by the following figures:

	<u>Sorties</u>	<u>Tons (GP)</u>	<u>Tons (frags)</u>
Continent-based a/c	333	72.25	54.7
U.K.-based a/c	<u>216</u>	<u>71.25</u>	<u>14.0</u>
	559	143.5	68.7

Nine groups carried 500-pound GP bombs, three carried 260-pound frags, and two more a combination of 500-pound GP and frags. One P-38 group carried two belly tanks of Napalm on each of its attacking planes. With the exception of one bomb which was hung up, all bombs were dropped in the target area. There were no losses and no encounters with enemy aircraft.

Ninth Air Force mediums had likewise exerted their full strength. Approximately 580 aircraft attacked. The Bostons delivered 137 tons of 500-pound GP's on their St. Gilles targets while over 4,000 x 260-pound frags were dropped from the Marauders. Again no exact estimate

[REDACTED]

[REDACTED]

of results is possible although a large proportion of the bombs were reported to have fallen on the targets. One bomber was lost to flak. Unfortunately 42 B-26's dropped short on the 30th Infantry Division, causing casualties and delaying its advance.

Fighter-bombers under the operational control of IX TAC delivered further air strikes in cooperation with the ground forces after sharing in the assault phase of the 25 July operations. Between 1135 and 2104, 13 armed reconnaissance missions of squadron strength or less were flown over the battle area to attack a great variety of targets selected by their leaders. Other squadron-strength missions were directed against specified targets. These struck communications centers, observation posts, and enemy headquarters and troop concentrations. Direct hits were made on important buildings, one church tower used for observation was destroyed and another damaged, tanks in a wood near Coutances were hit, while the dive bombing of roads in St. Gilles produced two large explosions. Before the day's end fighter-bombers had destroyed a bridge east of Gavray and, in evening missions, planted delayed action bombs (fused at 1 to 12 hours) on cross roads in the vicinity of Coutances to render night traffic hazardous to the enemy.

The Effect of Air Assaults by the Ninth Air Force

The immediately visible result of the combined air offensive of 25 July was the appearance of a pall of smoke over the entire area. This was reported to be about 8/10ths, rising up to 2,000 feet and

[REDACTED]

[REDACTED]

funneling out towards the north and beyond Carentan. Its northward movement tended to obscure target areas. As viewed from the air the effect of bombing upon the general area appeared devastating. More specific evidence was later derived from the interrogation of prisoners of war. These declared that communications were shattered with resulting confusion and that the heavy air bombardment caused troops exposed to it to be badly shaken, at least for a time. Both inexperienced and experienced troops appear to have suffered equally from shock, the younger among them being the quickest to recover. On the other hand casualties were reported to have been very light in proportion to the scale of effort. Dispersion, or even withdrawal, together with the slit trench or fox hole, prevented casualties except on occasions of a relatively few direct hits. Some materiel was destroyed or damaged by hits or fragments, but much heavy equipment was withdrawn in the intervals between successive air attacks. Apparently the enemy's avenues of retreat were not closed by the early assaults.

The "War Diary of the 7th German Army" exhibits further evidence regarding the air action on 25 July. Its observations, made on a high command level, are not entirely in accord with the evidence of prisoners of war. They insisted on the 25th that a break-through had⁵ been prevented, but stated that

our troops suffered heavy losses in the MLR and in the artillery positions. These casualties were caused mainly by the tremendous commitment of the enemy's air forces and the artillery barrages which lasted for hours. . . . In the over-all picture the enemy was repulsed on all fronts and he succeeded in penetrating only where our troops were hampered in the defense or completely eliminated by concentration of artillery or pattern bombing.

[REDACTED]

On the 26th a break-through was admitted and air's share in it indicated.

The enemy's unimpeded and concentrated employment of the air force proved, in the clear weather, a powerful check on our own defense and on the concentration of our reserves. The various penetrations effected by the enemy, which could not be checked for the time being because of our lack of reserves, created a serious break-through on this part of the front.

Some additional evidence as to the results of the air attack is derived from U. S. Army sources. On the 4th Division front the enemy's communications were so disrupted that he was forced to resort to runners exclusively, a fact which contributed to the disorganization of the defense. Only small-arm fire was there encountered. Advancing U. S. armor was delayed in its progress until engineers could fill craters in the roads produced by 500-pound GP bombs without instantaneous fuzing. Three regiments of the 9th Division attacked immediately after the aerial bombardment, gained appreciable ground, and ultimately won their objectives. The 47th Regiment, however, had been disorganized by short bombing and its attack was delayed for one to one and one-half hours. In the interval SS and paratroops organized the most serious resistance which the division encountered. The 30th Division had been hit by short bombing both on the 24th and 25th. It suffered from resulting disorganization and from artillery fire coming from positions to the southeast of our troops, which gave trouble for the first 12 hours of the attack. It appears that after the partial attack on 24 July the enemy had removed heavy machine guns and almost all his artillery as far back as Marigny. Enemy infantry, however, offered little resistance.⁶

[REDACTED]

On the basis of such evidence it is difficult to assess the exact extent of air power's contribution to the success of the operation which its bombardment initiated on 25 July. Nevertheless, there is ground for the confident assertion that the air strikes of the Eighth and Ninth Air Forces on 25 July were the critical factor in enabling the infantry to breach enemy positions west of St. Lo on the 25th and 26th and to open the way for armor to swing into action.

The Period 26 to 31 July

The break-through west of St. Lo was negotiated on 25 July. In the six days from 26 to 31 July the assault front was extended westward and armored columns spear-headed a rapid advance to the south through Marigny, St. Gilles and Canisy, Lessay and Periers. By the 28th they had penetrated Coutances and reached points near Brehal, Gavray, Percy, and Tessy sur Vire. Resistance continued strongest on the right flank of the advance in the areas about Villedieu, Percy, and Tessy, but progress continued in the coastal area. By the 31st, Granville had been taken, and the advance south had passed through Avranches to Pontaubault and Ducey.

IX Tactical Air Command

As armor and infantry thus exploited the break-through the Ninth Air Force was given its first considerable opportunity to coordinate its efforts with those of the ground forces in warfare involving rapid movement. As had long since been planned, IX TAC, under the command of Maj. Gen. Elwood R. Quesada and functioning in the closest

[REDACTED]

collaboration with FUSA, remained fully responsible for the provision and direction of fighter-bombers participating in air-ground cooperation missions. The tremendous scale of its effort from 25 through 31 July is shown by the following table.⁷

<u>Date</u> <u>July</u>	<u>Sorties</u>	<u>Tons of</u> <u>Bombs</u>	<u>E/A Claims</u>	<u>Lost</u> <u>(Air)</u>	<u>Total</u> <u>Lost</u>	<u>Total</u> <u>Damaged</u>	<u>Recce</u> <u>Sorties</u>
25	1,546	451.5	7-0-7	1	4	24	79
26	1,561	507	17-1-6	2	16	43	122
27	1,451	344	11-0-5	0	17	43	104
28	1,250	157.6	12-3-1	2	10	18	96
29	1,038	285.8	0-0-0	0	8	17	29
30	1,320	294	15-7-6	2	14	67	84
31	<u>1,019</u>	<u>241.25</u>	<u>5-0-2</u>	<u>3</u>	<u>9</u>	<u>6</u>	<u>141</u>
Totals	9,185	2,281.15	67-11-27	10	78	218	655
Total Recce	<u>655</u>						
Total Sorties	9,840						

Armored Column Cover. The most characteristic and significant type of mission flown in this period was that described in the records as "Armored Column Cover." Such missions began on 26 July, as armor began its swift movement in three columns which soon fanned out to drive against Coutances, Granville, and Villedieu. Constant cover was provided by relays of four fighter-bombers armed with bombs or rockets and flying half-hour shifts over the head of a given column. Air-ground communication between flight leaders and tank commanders was effected by VHF radio, IX Air Force Service Command having installed air force type SCR-522 sets in the armored vehicles for the use of the column commanders. On occasion pilots accompanied the ground commander to advise him concerning the capabilities of air. If the armored column required cooperation it could call for air action and

specify its nature. In addition the flight leader was in a position to convey useful intelligence to the column commander and could attack profitable targets of his own selection, after coordination with ground control.

On 26 July four plane flights flew more than 70 of these armored column cover missions; on the following day 100 such missions were flown by IX TAC units. The other days of the period saw like actions on a varying scale.

Reports of air action of this type for 26 and 27 July give useful examples of the work accomplished in the course of the drive from St. Lo to Avranches and beyond. On the 26th individual flights included in their reports such items as: 15 rockets fired, 2 tanks destroyed, 1 probably destroyed, 1 tank destroyed by strafing; 14 rockets fired at tanks, 2 destroyed, 2 damaged; 2 tanks destroyed by rockets, 2 by strafing; 8 bombs on 2 Mark VI tanks, left burning; 7 bombs on 4 tanks, no hits; 8 bombs on Tiger tanks, 1 destroyed, 1 probably destroyed; 2 Tigers holding up our advance, dive-bombed with poor results, then strafed and destroyed. Bombs were likewise reported dropped on gun positions, AA installations, road junctions, and a hedgerow on a road northeast of Coutances. The records for the 27th exhibit evidence equivalent to that afforded by the actions of the previous day and add other types of targets: command post southwest of St. Lo left in flames; 8 bombs on convoy south of Canisy, 4 tanks, 2 MT, 1 staff car destroyed, 8 trucks damaged, entire convoy dispersed; 8 bombs on

strong point near Quibehou, church and 4 buildings destroyed, town strafed, full of troops and guns; 8 bombs on target marked by white smoke; 8 bombs on convoy of 50-plus southwest of Coutances, 1 tank and 7 MT destroyed, 7 tanks and 8 MT damaged.

Targets like those attacked on 26 and 27 July appear in the records of the succeeding days' actions by armored column cover, notable additions being horse-drawn artillery and vehicles. One mission on the 28th claimed to have killed all horses drawing five guns and to have hit the guns and killed six horses drawing MT, while another strafed 40-plus horse-drawn vehicles, killing 90 horses. A mission on 30 July struck a three-fourths-mile column of horse-drawn artillery and men on the Villedieu-Granville road. Its claims were 65 horses killed, 20 artillery pieces destroyed, and many troops killed and wounded. Taken together, results of the sort indicated by the above selections from mission reports demonstrate the fact that armored column cover assisted the armor to advance by removing opposition, and suggest that by clogging traffic on roads it provided profitable targets for later armored attack.

Only on occasion is detailed evidence available of cooperation between tanks and their covering planes; hence the following episodes which occurred within this period should be cited. A single Sherman was surrounded by 13 German tanks. It was saved from threatened destruction by the covering flight which was directed to its assistance and dispersed the enemy. "Is the road ahead safe for us to proceed?" was the question radioed by a tank commander to a flight leader. The

[REDACTED]

answer came, "Stand by and we'll find out." In their ensuing search the four P-47's spotted four enemy tanks down the road which they attacked and put out of action. Returning to the friendly column the flight leader radioed, "All clear, proceed at will."⁸ When radio was jammed the bombardment of a railroad station by the tanks served as a signal for a dive-bombing attack on the same objective on the part of the accompanying planes. Tracer bullets from tanks served to indicate targets to the P-47's in another case.⁹ In response to a column commanders' request aircraft swept the road ahead with fire. They radioed, "Go ahead," but recalled that direction immediately. "There's one we missed. Tank at right side of road next building up 200 yds. ahead of you." The camouflaged tank was dive-bombed.¹⁰ On another occasion a Tiger tank was discovered hidden among trees. Strafing set it on fire and its crew were seen leaving the tank and surrendering to the armored column.¹¹

Armed Reconnaissance in the Battle Area. Armed reconnaissance within the battle area was another characteristic type of mission flown by IX TAC from 26 through 30 July. On the 26th, 16 such missions were flown, eight aircraft participating in each. The 27th saw 11 missions of squadron strength and seven of eight aircraft each; five were undertaken by squadrons and five more by eight aircraft each on the following day, while six of squadron strength were flown on the 29th and a single one, again of squadron strength, on 30 July. Their individual and gross results were of a substantial order, none more so than those of the

[REDACTED]

[REDACTED]

10 missions flown by 405th Fighter Group between 1510 and 2140 on 28 July.

The 405th Group had been assigned to fly armed reconnaissance all day, but weather did not allow its planes to take off before the afternoon. They then proceeded to Villedieu, where they found few targets. However, as they widened the area of their search they discovered a mass of traffic moving south on the roads in the vicinity of Brehal, Gavray, and Percy. In places transport was moving bumper to bumper. From the very start the damage inflicted upon these enemy targets was enormous. In the case of one long column the head and tail were first attacked so that the whole was soon immobilized, allowing its elements to be systematically blasted. One pilot and his wingman asserted that they had set fire to 35 MT in one long pass before they lost count. The first squadron to attack radioed the news to the Controller with the result that the group rotated its squadrons in the area throughout the afternoon, returning planes being rearmed and refuelled and taking off again. For more than six hours these attacks on transportation targets continued with a total of approximately 100 aircraft participating. In the midst of the mele¹ a general radioed from a tank, "Go to it! Get one for me!"¹² The pilots' claims would appear fantastic had the assault not been sustained in such strength for so long a time, and had the targets not been of so extraordinary a nature. As it was, pilots asserted that they had seen over 400 MT in flames plus 12 tanks and sundry other vehicles. A ground check, effected after much debris had been cleared from the

[REDACTED]

[REDACTED]

roads, tended to substantiate the reports. The effect of this successful action upon the group was exhilarating. As one returning pilot declared, "I have been to two church socials and a county fair, but I never saw anything like this before."¹³

Summary of Activities. Armored column cover and armed reconnaissance missions on any given day were usually planned in advance by IX TAC and FUSA. Other significant air-ground cooperation missions in the period were the result of action taken on requests from ground units for air strikes, which if successful would assist their advance. Such requests usually emanated from Army corps and called for attacks on targets on their immediate front. Enemy artillery positions, command and observation posts, strong points and supply dumps were characteristic of the targets thus designated for attack. It is interesting to observe that the ground forces canceled a number of such strikes. They had been scheduled promptly after receipt of the requests, but the swift advance on the ground placed troops too near the targets to permit the delivery of the attacks at the times scheduled.

Other air-ground cooperation missions during the drive to Avranches need only to be mentioned. The practice of dropping delayed action bombs on road junctions in an effort to hamper enemy movement by night, begun on the evening of 25 July, was repeated on the 27th and 28th. While related to the general interdiction program the 10 attacks on bridges within the battle area on 30 July were determined by IX TAC and FUSA, which fact warrants their inclusion in the long

[REDACTED]

list of air-ground cooperation missions. Five other attacks, made the same day against targets in proximity to the battle area and by order of Headquarters Ninth Air Force fall into another category, as do the armed reconnaissance missions beyond the zone of battle--e.g., those of 27 and 28 July and IX TAC's 16 strikes against fuel dumps on 31 July. In spite of such requirements and the occasional call to furnish escort to IX Bomber Command, IX TAC concentrated by far the greater part of its effort on air-ground cooperation missions from 25 to 31 July. Some of the results of such actions appear in its total ground target claims for the period.¹⁴

Tanks	384
Motor transport	2,287
Railroad and highway bridges	33
Railroad lines cut	46
Railroad cars	194
Locomotives	14
Road junctions damaged	85
Horsedrawn vehicles	125
Troop concentrations successfully attacked	38
Gun emplacements successfully attacked	71
Artillery	71
Military-occupied buildings	45
Dumps	12

On two occasions after 25 July, mediums of IX Bomber Command cooperated directly with the ground forces at the latter's request. Following the break-through at St. Lo three areas near Marigny were marked out for attack by two groups each on 26 July. Weather was again bad and only one group was able to carry out its attack, claiming heavy damage to a single installation. On 30 July British armor was reported to have been aided in its advance through enemy positions near Caumont by the bombing of three areas by IX Bomber Command mediums.

[REDACTED]

Two groups assigned to one area carried through their attacks. In the seven-group mission against a second area 195 bombed out of 252 dispatched. Later in the day in a six-group attack upon a third area, 243 aircraft were dispatched, of which number 199 bombed. Weather was adverse, and pathfinders led all attacks. The exact nature of the damage done to the targets is unknown.

Planning Air-Ground Cooperation. Such extensive air-ground cooperation as has been described above required the closest possible coordination of the ground and air elements involved. To assist in providing such coordination it was desirable that the intimate association earlier developed between IX TAC and FUSA be maintained and perfected. Some air strikes, chiefly beyond the battle zone, might still be determined at Ninth Air Force Headquarters, but the planning of the bulk of such missions was IX TAC's responsibility. To discharge that responsibility in this period its headquarters were established in close proximity to those of FUSA, first at Au Gay and later at Les Oubezux. There the close cooperation between air and ground reached its highest point in the joint conference held at 1930 hours daily, the purpose of which was to plan tactical air operations for the following day. Weather submitted its forecast; air and ground intelligence reported the results of the day's air and ground operations. A-2 then presented information from a variety of sources pertinent to current operations, and suggested targets for preplanned missions on the next day. G-3 (Air) then described the Army plan for

[REDACTED]

[REDACTED]

operations and presented requests for preplanned air missions, filtered from the requests submitted by Army corps. On the basis of the information provided, the air operations officer then proceeded to allot available air elements to various tasks--i.e., to air-ground cooperation, bomber escort, and targets deep in enemy territory--holding, as a rule, a small force as a reserve to meet unforeseen developments. Following this allocation of forces, specific missions were assigned to them, such assignments constituting a firm plan and the basis for the issuance of operational orders for the ensuing day. Such collective planning was essential to successful air-ground cooperation. It was reinforced by the continued activity of Air Support Parties with ground troops which assisted in formulating requests and in directing aircraft to their targets, and by ground liaison officers with air units who provided them with special ground intelligence, assisted in the briefing of pilots, and arranged for the marking of targets and the positions of friendly troops. The various elements involved in the provision of air-ground cooperation were so well integrated that in the extreme case of requests for missions to be flown "S[oon] A[s] P[ossible]," only 60 to 80 minutes normally elapsed from the time the request was initiated until the aircraft were over the target. When such requests for immediate action were anticipated, this time could be reduced by having crews alerted on the runway with their commander in the briefing room to receive the targets. Such teamwork ripened into a habit with IX TAC and FUSA. It ripened the more rapidly because of their joint participation in the fast moving

[REDACTED]

and critical air-ground operations from 25 to 31 July 1944.¹⁵

The Interdiction Program

IX Bomber Command

The Ninth Air Force steadfastly maintained its support of the interdiction program throughout July 1944 and, as previously, employed both its mediums and its fighter-bombers in the effort. IX Bomber Command continued its attacks on rail bridges, flying missions against such targets on 13 days. In all cases the attacks were delivered by single groups.

Seine Bridges

The enemy had been active in repairing or replacing Seine bridges which had been destroyed in May and June, and the progress of his work caused five to be attacked by the mediums in July. That at Courcelles was cut by a bombing on 28 July, and the center span of the new bridge at Le Manoir was destroyed on the 31st.¹⁶ Three attacks on Mantes-Gassicourt resulted in damage to rails and approaches only. No damage was produced by the bombing of Conflans, St. Honorine and Oissel. It should be added here that the repaired highway bridge at Rouen was destroyed by a bombing on 18 July.

Loire Bridges

Loire bridges, still intact or repaired after earlier bombings by other air forces, were now attacked. Missions against them involved operational flights of some 750 miles from the Essex bases of

bridge at Maison Lafitte lay in the river after an attack on 24 June. The following day the northern viaduct at Chartres³¹ was completely covered by the medium demolition of three piers. Attacks on Cherisy (25 June) and Thiron (25 June) failed to do more than damage the latter's approaches, while no results were observed at Giscel (22 June).

Fighter-bombers claimed hits in the course of 11 six missions flown against major bridges (21, 22, 23 June). A second attack on one at Montreuil-Bellay resulted in the claim of its destruction by glide bombing (21 June), and two supporting columns of one at Chartres were reported destroyed on the same day. Fighter-bombers on area missions included in their reports claims of some 20 subsidiary bridges destroyed. That at Coltonville, in the Cherisy area, was reported broken in four places. Ground observers substantiated the claim that the bridge at Dueil had been demolished. Its spans had earlier been destroyed by a heavy-bomber attack, but had been repaired with steel beams. Direct hits destroyed these and the interdiction was reinforced by hits on the approaches and by rail cuts in the vicinity.³²

The interdiction program had been steadily maintained throughout the month of June 1944. The scale of the effort and the minimum cost at which impressive results were obtained is exhibited by the following table:

	<u>Aircraft</u> <u>Attacks</u>	<u>Medium Bombers</u> <u>Lost</u>	<u>Fighter-Bombers</u> <u>Lost</u>	<u>Total</u> <u>Lost</u>
Marshalling yards	2,557	5	3	8
Bridges	2,923	6	6	12
Rail cutting	2,204	1	5	6

[REDACTED]

IX Bomber Command, but the bridges' value to the enemy in bringing his divisions from the south into the battle zone required that they be flown. Such extreme-range missions forced many planes to refuel on continental airfields before returning home, or to accept the risk of flying to their base on the minimum supply which remained. Other aircraft were compelled to land on the continent because of flak damage. Nevertheless, the attacks went on. Between 7 and 31 July seven Loire bridges, from Nantes on the west to Tours on the east, were bombed in the course of 16 assaults.

The first four attacks on Nantes produced only incidental damage, but the fifth (31 July) destroyed the center of the bridge. Only one bombing (19 July) was required to destroy five spans of the structure at La Poissoniere. Two attacks on Les Ponts du Ce were inconclusive, but the second of two at Saumur (12 July) dropped the center section of the bridge into the water. The single assault on the Cinq Mars bridges destroyed the middle span of the East, and damaged the West bridge. Tours la Riche was four times bombed, three attacks (7, 9, and 31 July) producing substantial damage by destroying spans. The enemy's repair activities account for the repeated attacks and serve as a useful indication of the interdiction program's value. So strenuous were his efforts to keep this valuable bridge open that after one attack he repaired two broken spans in the extraordinarily short space of six days. Finally, the bridge at La Frilliere was cut in four places in a single attack (31 July). During the month six out of the seven selected bridge targets were put out of action, at least temporarily, by IX Bomber Command.

[REDACTED]

[REDACTED]

The Paris-Orleans Gap

Thirteen medium-bomber missions had as their objectives like targets in the Paris-Orleans gap, where six bridges and a viaduct were bombed. Damage to tracks or approaches resulted from single attacks at St. Remy sur Avre, Cherisy, and Epernon. The last of three attacks on Nogent le Roi (18 July) rendered the bridge there unserviceable. Bombing of a bridge at Chartres on 25 July placed it in the same category, but another attack on the 31st produced no definite results. A first bombing of the vital structure at Cloyes destroyed half of it (6 July), and a return visit (25 July) completed the job. Probable severe damage was reported following the first assault on the Maintenon viaduct (6 July); but none was recorded after that on 25 July. In consequence of July attacks three bridges in the gap had been put out of action.

Bridges within the Interdiction Zone

In July, as in the earlier phase of the interdiction program, attacks on the rim of the interdiction zone (Seine and Loire river bridges and those in the Paris-Orleans gap), were supplemented by bombings of bridges within the zone itself, the total of 27 such attacks by IX Bomber Command involving 16 different targets scattered over a wide area. Results were rather less conclusive than those produced by the interdiction program bombings treated above. In eight cases the targets were destroyed or rendered unserviceable. The last of three attacks on St. Hilaire du Harcourt destroyed the bridge spanning a road (19 July), and the third of four bombings at Ambrieres (24 July)

[REDACTED]

[REDACTED]

resulted in a cut of 500 yards. At Boissei la Lande, Mirville, Souvigny, and Serguigny one attack rendered the bridges unserviceable. Although reported completely destroyed by the bombing on 16 July, Laigle was again struck with inconclusive results a week later, while the reconstructed span at Laval was destroyed on the 24th.¹⁷ Damage to rails or approaches was the most that could be reported as the result of attacks on the remaining eight of these bridge targets, although one was bombed twice and another three times. It is to be observed, however, that such damage could be extremely significant. In one instance (Grosley sur Fisle, 28 July) ground observers later reported that damage to approaches blocked traffic as effectively as the destruction of the bridge would have done.¹⁸

Thus a total of at least 19 bridges of special importance to the interdiction program had been effectively broken or blocked by IX Bomber Command's actions in July 1944. A total of 35 such targets had been subjected to 64 attacks of group strength, 55 delivered by B-26's and 9 by A-20's. In 27 attacks pathfinders had been employed, in 23 instances for bombing targets inside the periphery of the interdiction zone. Available evidence indicates that in all attacks GP bombs were used, the B-26's dropping 1,000-pound GP's in 35 of their assaults, 2,000-pound GP's in 17 other instances, and 500-pound GP's in two more. They dropped some 260-pound frags with their 2,000-pound GP's in one case, and 1,100-pound GP's with 1,000-pound GP's in another. A-20's used 500-pound GP's in all their attacks, while

[REDACTED]

[REDACTED]

pathfinders employed a variety of GP's ranging from 300 to 2,000 pounds. The B-26's were responsible for the destruction of 16 bridges, the A-20's for that of the remaining three.

Attacks on Rail Lines and Embankments

On 6 July an earlier experiment was repeated in the use of IX Bomber Command aircraft for a series of attacks against rail lines. Six sections of lines within the interdiction zone were assigned to as many groups. On each section six pin-pointed targets, chiefly minor railway bridges, were marked out for attack. Five-hundred-pound GP bombs were to be carried; and two, six, or eight, as specified in the field order, were to be dropped on individual targets. The experiment was unsuccessful. Cuts were reported in rail lines at seven points, the most effective being in the vicinity of the Alencon bridge, a secondary target where six bombs cut all lines. There was no reported damage to the bridges which figured so prominently in the target lists. The experiment in bombing of scattered targets by portions of B-26 and A-20 formations was not repeated.

On the other hand, the interdiction program was effectively reinforced by attacks delivered by the mediums upon railway embankments in July. Such targets were assigned to single groups and successful results were reported following each of the nine attacks delivered from 11 to 31 July. The embankment at Bourth was bombed four times and those at Chaulnes, Evreux, La Croisille, Argentan, and Forges once

[REDACTED]

[REDACTED]

each. The blocks thus established were substantial, although the attacks on Bourth at three-, eight-, and six-day intervals suggest that they were effective only for brief periods.

Fighter-Bomber Attacks upon Rail Targets

The interdiction program had been conceived and developed on a grand scale. As previously noted, its success depended not merely upon breaking down the bridges within the interdiction zone and on its periphery, but also upon cutting the lines and destroying rolling stock within the zone. Fighter-bombers were the weapons chosen to cut the rails and blast locomotives and railway cars, their actions in July as in the preceding months being directed by Ninth Air Force Headquarters at Uxbridge. Missions flown against such objectives were seldom aimed at specified targets. Almost without exception they were described either as "armed reconnaissance" of given areas or as "rail cutting" along assigned sections of railway lines. It is to be observed that no useful distinction can be drawn between the "Armed Recce. Alencon, Chartres, Cloyes, Le Mans," and "Rail Cutting La Hutte Colombieres-Le Mans." The mission leaders were in both cases free to determine the precise objectives of their bombing and strafing attacks. In each case the chosen targets were certain to include bridges, rails, or rolling stock, alone, or more usually, in combination.

IX Tactical Air Command

Aircraft under the operational control of IX TAC were used to support the interdiction program only on rare occasions in July, since they were so heavily committed to the work of air-ground cooperation.

[REDACTED]

[REDACTED]

But on 16 July they cut tracks and destroyed rolling stock west of Angers. On the 16th, in the course of missions against five specified bridge targets, they hit the bridge at Cherisy, damaged that at La Loupe, and destroyed the one at Andaevillers. Again on 30 July Ninth Air Force Headquarters directed that IX Tactical Air Command attack bridges named in orders. All targets were hit; that at Nantes and one of the two at Tours were claimed destroyed.

IX Fighter Command

In marked contrast to those under IX TAC, the aircraft under IX FC's operational control concentrated their energies upon interdiction. The plans for such actions were developed by the headquarters of IX FC and Ninth Air Force whose joint action was facilitated by the location of both at Uxbridge. IX FC reported over 150 interdiction missions on a total of 24 days in July. Twenty appeared in the record of 4 July and 15 and 12 in those of the 6th and the 20th respectively. The average number for the 24 days of activity was 6.3. Almost without exception a group was assigned to each mission, although the attacks were delivered by squadrons.

The area subjected to most intensive and most frequent attack lay between the Seine, the Paris-Orleans gap, and the Loire on the one hand, and the battle zone on the other. It is of interest to observe, however, that as July wore on, attacks reached beyond these boundaries on the east and on the south. As early as the 6th, missions were directed to areas south of the Loire in an effort to discover and

[REDACTED]

destroy enemy reinforcements moving north. Areas as far east of Paris as Chalons appear in the assignments for the 12th, while interdiction was extended to Clamecy, southeast of the capital, by the 16th. On the 19th, areas in western Belgium appeared for the first time in the July interdiction program in connection with an effort to destroy supply trains.

Bridges, which constituted the usual targets for IX Bomber Command's interdiction activities, were but infrequently attacked by IX FC's fighter-bombers. Such attacks as were made were reported successful. A Seine bridge at Mantes-Gassicourt was claimed destroyed by a bombing on 4 July, and Nogent le Roi was cut by one on the 14th. In both of these cases the structures were marked for special attack. A pontoon bridge near Louviers was destroyed on 8 July in the course of a mission directed against such targets over the Seine, while in area missions bridges at Segre (12 July), at Chateauneuf (13 July), and near Montfort (18 July) were singled out and broken by attack. A bridge at Chartres was reported destroyed on the 29th.

The detailed results of fighter-bomber attacks delivered against rail lines and rolling stock at high speed and low level can better be estimated than precisely defined. A good idea of their character and extent may, however, be gained from an examination of the records of days of marked interdiction activity and outstanding individual missions.

Leaving out of consideration such vague reports as "bombs on tracks," "train strafed," and "marshalling yard hit," the claims for

[REDACTED]

the days of unusual activity were¹⁹

	<u>Rail cuts</u>	<u>Locomotives</u>	<u>Cars</u>
4 July (20 missions)	30	5	113
6 July (15 missions)	23	13	51
20 July (12 missions)	35	11	69

High scores of 103, 75, and 70 cars destroyed figure among the claims reported by individual missions on 23, 4, and 14 July respectively. Among the results of a mission on 23 July was a claim of 43 rail cuts, while another on 8 July included 33 in its listings, in addition to an ammunition train which exploded under attack near Tours. A single mission on the 13th claimed 25 tanks and armored cars on a siding in the Nogent-Mamers area, in addition to 1 locomotive, 34 cars, and 3 rail cuts. Trains loaded with equipment were caught in western Belgium (20 July) and claims of 7 locomotives and 26 cars reported by the group attacking. Fuel tanks containing Napalm hit a steel train on 23 July, while rockets were employed in a mission which reported the destruction of 51 cars on the 17th. More typical records read "14 hits on railway Le Mans-Coulommieres" (4 July); "2 cuts, 2 locomotives, 24 cars (16 July)"; "3 cuts, 3 locomotives, 10 cars" (20 July); and "3 cuts, 1 locomotive, 24 cars" (30 July). In no case did a mission which reached its assigned area fail to inflict some damage. Because of the varied, and at times vague, reporting of missions of this type during the month it would be profitless to attempt to present the totals of the various claims for the period. It is evident, however, that they were impressive.



Two further items in respect to the interdiction program require mention. First, while some claims appear of motor transport destroyed in the course of area attacks, such claims were infrequent and small, possibly because of the enemy's restriction of road traffic to the hours of darkness but more probably because our aircraft concentrated their attention on rail targets. Second, in a few instances interdiction missions encountered enemy aircraft. When they did so, their actions contributed to the maintenance of our air superiority as the following table shows.²⁰

<u>July</u>	<u>Enemy Aircraft in Air Encounters</u>	<u>Losses</u>
4	5-5-3	0
4	0-1-1	2
4	1-0-0	0
6	3-1-4	2
13	4-0-0	0
14	6-1-2	5 (missing)
18	10-6-14	3 (2 missing)
25	4-0-5	1 (unknown)
26	2-0-3	2 (unknown)
27	5-0-0	0
27	0-0-2	0
Totals	40-14-34	15 (11 missing or unknown)

Planning Interdiction Operations

In July, as in all other periods of the interdiction program, it was essential that the rail bridges on the periphery of the area be denied to the enemy in spite of his vigorous efforts to effect their repair. It was likewise essential that he be denied the use of as much as possible of the rail complex within the interdiction zone through the destruction of bridges and the cutting of vital lines.



To achieve such ends extreme vigilance was required on the part of those who planned and directed the operations. It was comparatively simple to determine the main bridges to be brought down. It was more difficult to select those lines on which cuts should be made. But most difficult of all were the closely allied tasks of assessing the damage done to bridges and rails by attacks which had been carried through, and of planning further attacks to offset the enemy's repair work on bridge structures and to maintain constantly the requisite number of cuts on rail lines. In other words, constant vigilance was essential on the part of the planners if bridges were to be not merely brought down but kept down, and if rail cuts were to be kept at the desired level.

Reports rendered immediately following missions were of uneven quality; hence effective photographic reconnaissance became a matter of prime importance to the planners. Under favorable circumstances the task of obtaining such evidence in respect to bridge structures was comparatively simple, although the great number of rail cuts scattered over a wide area made their complete reconnaissance coverage extremely difficult. In July, however, the situation was not favorable, for adverse weather severely restricted photo reconnaissance as well as other air missions. In its absence, therefore, the planners had to reassign some bridge targets for attack after the lapse of the estimated time needed to effect the repair of damage earlier inflicted, and without definite knowledge of their status. Similarly, since the stakes were high and since the principle that "when in doubt, take

[REDACTED]

the trick" applied, they heavily accented the work of rail cutting even though exact knowledge of the number of effective cuts was lacking at the moment when further attacks on rails were ordered. Meticulous planning under difficult conditions, coupled with the skill and daring of pilots and the ability of ground crews to keep the requisite number of aircraft on the job, caused the interdiction program to achieve a notable over-all success.

Evaluation of Results

As has been frequently observed, the results of individual interdiction missions are hard to assess, and the assessment of the work done by the different types of planes employed is almost equally difficult. Enemy sources, however, pay tribute to the cumulative effects produced by the mediums and fighter-bombers which shared in the great work of interdiction.

Enemy Evidence

Such evidence is available in the shape of the captured "War Diary of the 7th German Army." Its observations speak for themselves. On 6 July the Diary states that "the transportation situation makes it impossible to forecast when the 275th Inf. Div., one combat team of which is already committed, can be brought up." Two days later entries declare that "enemy bombing and strafing attacks against troop concentrations and movements, as well as against supply traffic, continue and are inflicting noticeable loss," and assert that the prevailing scarcity of transport facilities is "attributable for the most

[REDACTED]

[REDACTED]

part to the overwhelming and constant air superiority of the enemy."

The point is again stressed on the 10th:

These units [portions of the 343d, 265th, and 266th Infantry Divisions in Brittany] no longer possess any motorized transportation since everything available was used to motorize the combat groups that were taken out. The remaining vehicles, both our own and those requisitioned locally, must remain with the divisions to bring up supplies, especially since the latter has become extremely difficult due to the large size of the sectors and the destruction of railway facilities. The 2nd Paratroop Div. which is being formed is likewise completely non-motorized.

A statement on 15 July declares that the battle of supply as waged from the air by the Americans "was unprecedented in its severity."

Those which appear on the 19th and 20th elaborate this text:

The army supply situation must still be regarded as strained. It is true that there has been a slight decrease in the rate of gasoline consumption at the present time among the troops fighting in Normandy. However, since we cannot count on any supply worth mentioning for the next few days, and since the gasoline trains have not yet arrived, we must figure on a decreased supply. In consequence of the failure of rail transportation because of the long periods of heavy fighting, a decrease in ammunition supply below the basic quota was inevitable. . . . If the ammunition trains do not appear, a serious ammunition crisis must be expected within three or four days.

Only if several ammunition and fuel trains arrive, will the tense supply situation be eased. The difficulty is caused by the increased interruption in railway lines and the lack of sufficient motor transport space. If it is not possible to bring up the supply trains, a further deterioration of the supply situation must be expected.

One cause of the crisis thus emphasized is given in the Diary entry for 20 July. "On the evening of July 19, four bridges over the Loire were eliminated because of the lack of antiaircraft protection." Actually the bridges had been "eliminated" by positive action on the part of IX Bomber Command which attacked bridges at Nantes, La Poissoniere,

[REDACTED]

[REDACTED]

Les Ponts du Ce, and Tours la Riche between 1952 and 2002 on 19 July and gave a lower estimate of damage done than that contained in the German statement. An entry on 20 July rounds out the enemy's commentary on the interdiction program as affecting supply. Commanding General West and Field Marshal von Kluge then held that among "urgent measures" to be taken was "the assurance of increased munition and fuel supply by means of supply replacement transports, the security of which is to be effected through fighter and antiaircraft protection, particularly for the Loire bridges so important to the [7th] Army."

On 25 July the effect of interdiction on reinforcement of the battle lines is suggested by the comment that an agreement was then reached to make a withdrawal which, by shortening the front, would free troops for use elsewhere. It was made "only because it was impossible within eight days to bring up fresh forces to the Army."

The above entries are all of unusual significance. Collectively they establish the fact that interdiction was in July, as previously, a cause of major difficulties to the enemy. Those of 19 and 20 July, describing the enemy situation in the days preceding the great American assault of the 25th, afford conclusive evidence that the long continued work of interdiction on the part of the Ninth Air Force was one of the fundamental causes for the break-through west of St. Lo and for its rapid exploitation in the remaining days of July.²¹

[REDACTED]

American Evidence

An official study by the Economic Objectives Unit, Economic Warfare Division, Embassy of the U.S.A. (London) reinforces the general conclusions drawn from German sources and adds pertinent details concerning the effects of the interdiction program on enemy troop movements in the period 6 June to 26 July 1944.

Destruction of bridges over the Seine forced elements of five enemy divisions to make the crossing by ferry. Some divisions coming from Holland, Rumania, or the U.S.S.R. detrained in the Paris area and moved on foot to the battle area. Six to seven days were required by the 16th GAF Division to make a march of 150 miles in late June, while the 9th and 10th SS Panzer Divisions detrained at Versailles and other points just west of Paris and proceeded by night marches on secondary roads. There was little uniformity in the time their units required to reach the battlefield: one arrived after two days, while others consumed two weeks in their movement.

The broken bridges over the Loire "for most of the time constituted an impassible barrier . . . More than half of the troops detrained at the Loire and marched six to 12 days into battle." Even those which did cross on bridges which were temporarily in operation did not advance more than 50 miles before detraining and subsequently moved on foot for four to 10 days, the extent of their march depending on the availability of motor transport for part of the distance which they had to cover. In consequence three divisions coming from

[REDACTED]

the Bayonne and Harbonne areas averaged from 120 to 130 miles per day south of the river, and only 75 to 90 miles per day north of that barrier. The movement of one of these divisions (276th Infantry Division) from Bayonne to the battle area began on 11 June and spread over a month's time, largely because of delays caused by the changing status of Loire bridges. "Had even one bridge been open over the whole period, the move could have been accomplished in a considerably shorter time."

The American, like the German report indicates that movement from Brittany to the battle zone was seriously restricted. The 266th Infantry Division required the full 15 days from 11 to 25 June to negotiate 140 miles, limiting their marches to hours of darkness and keeping as far as possible to side roads. In the same period the 353d Infantry Division took between 14 and 15 days to cover 150 miles. Both divisions utilized any available transport--e.g., bicycles and horse-drawn vehicles--to assist their movement. It is significant that elements of each were forced to detour around such places as Vire, Avranches, Villedieu, and Tessy because of bomb damage to highways within those towns.

Attacks on bridges, rail cutting, and the destruction of rail transport forced virtually all troop movements within the Seine-Loire arc to take to the roads. Continued attacks on daylight road movements by fighter-bombers forced the enemy to limit his marches to the hours of darkness and to disperse his columns over secondary roads. But the adoption of such procedures cost the enemy dear.

[REDACTED]

[REDACTED]

March timetables were perforce lengthened because the nights were short and night movement is slower than that by day. Moreover, dispersed movement by company or platoon units meant that their arrival at their destination was disorderly, and caused units to be committed piecemeal with inadequate organization of commands.

Thanks to enemy repair activities, it was inevitable that all lines should not be simultaneously blocked and that, after the first two weeks had passed, careful routing of trains should neutralize in part some of the effects of the interdiction program. However, in spite of the enemy's energy and skill, attacks on troop trains in transit and the systematic interdiction of all available through lines affected divisional movements significantly.

The general conclusions drawn from such evidence by the American authorities are both clear and valuable. Because of interdiction "the enemy was unable to use the rail system inside the Seine Loire area for any large scale movement of troops. . . ." Furthermore, "the decisive reduction in the speed of movement to the front was that caused by detrainment at the rim of the Seine-Loire arc, and movement therefrom by MT and on foot." The net result of the effort is summarized in the emphatic statement that "It is now evident that the enemy failed to match the Allied build-up in the lodgment area, and that the continued attacks on his transport facilities played a large part in that failure."²² The concentration of the Ninth Air Force upon the interdiction program entitles it to a considerable

[REDACTED]

share of credit for the results evident in the months of June and July 1944.

Attacks on Enemy Supplies

The Ninth Air Force frequently attacked fuel and ammunition dumps through July. A variety of intelligence, chiefly that derived from prisoners of war, indicated that enemy shortages of these two essentials were often of a critical nature. With a view to reducing the enemy's stocks, already depleted through the success of the interdiction program, the Ninth Air Force repeatedly attacked such dumps, particularly those in close proximity to the battle zone.

In the course of the month IX Bomber Command attacked 12 different targets of this type at least once, a total of 24 attacks being delivered against three ammunition dumps, a fuel storage depot, and eight fuel dumps. Since the dumps were usually located in dense woods it was seldom possible to gauge the results of bombings with any real accuracy. The appearance of craters in the target area was almost the only evidence immediately available, but the desire that already critical shortages should be rendered more acute caused IX Bomber Command to assault six installations twice, two three times, and one on four occasions within the period. The attacks were made by single groups in 12 instances, by two groups in seven others, and by three groups in four cases. The size of the attacking force was partly determined by the necessity of assuring reasonable success in area bombing.

[REDACTED]

In nearly all cases the target areas were well hit, out as noted above, no precise assessment of damage is possible with the exception of five targets where ground observers' reports cast light on the situation. In two cases results were negative. All three of the attacks on the fuel dump at Foret de Conches (6, 22, 23 July) were made after the enemy had evacuated it.²³ Some tank trucks in the Foret d'Ecourves (11, 13 July) had been destroyed, but it too was probably evacuated when the two attacks of this period were delivered.²⁴ In other cases positive results are established. The Foret de la Guerche was attacked on 16 and 31 July. There 100-pound GP bombs had been used with marked effect on the drums stored in bunkers or trenchers. Many were ruptured by internal expansion and all were burned or scorched.²⁵ The gasoline storage depot at Rennes was likewise twice attacked by the mediums, and also by fighter-bombers in July, but the attacks of the mediums on 9 and 17 July seem to have been responsible for most of the damage done. This included not merely 75 per cent damage to offices and warehouses, but also the destruction of some 2,000,000 liters of gasoline for which the Wehrmacht hungered.²⁶ The observers' report on their findings at the ammunition dump at the Foret de Senonches (20, 26, 28 July) includes the effects of the mediums' repeated attacks in June as well as of their three attacks by three groups each in July. Here the stores were ranged in over 600 stacks well dispersed over an area of two square miles. Seventy of these stacks had been destroyed, some by casual strafing on the part of fighter-bombers, involving the loss of

[REDACTED]

some 10 per cent of the stores. Much of this damage, however, was apparently caused by an attack on 25 June.²⁷

Fighter-bombers also attacked fuel and ammunition dumps in the course of the month. On occasion IX TAC struck at such targets. Four were hit in the St. Lo-Ferriers area between 5 and 16 July with fires or explosions resulting. Similar results were produced by attacks of 18 and 19 July on two like targets in the same area, while black smoke indicated that some measure of success attended the attack on a dump at Vitre on the 17th. IX TAC's most concentrated effort against targets of this type was made on the last day of the month when no less than 16 strikes were scheduled on some 11 targets selected by Headquarters Ninth Air Force. Fuel tanks at Tours were twice attacked and left burning. At Rennes fires and smoke followed two bombings of the target area. Since no fires resulted after direct hits on tanks at Pontorson and Angers, the containers there were believed to have been empty. Six other targets were hit with less definite results observed. Fighter-bombers on armed reconnaissance under the operational direction of IX FO selected such targets on occasion, as when they hit a fuel dump at Sens (13 July), destroyed an ammunition dump southeast of Bueil (16 July), damaged oil tanks at Orleans (20 July), and destroyed one in the Amiens marshalling yard (26 July).

In the case of attacks by the mediums, available evidence suggests that where the dumps were stocked at the time of the bombings the results were the best that could be expected in view of the type of target attacked and the force employed. Furthermore, in

[REDACTED]

attempting to measure the success of any attack, whether by mediums or fighter-bombers, two questions arise. First, did the destruction of supplies contribute to the over-all shortage which we know existed? Here the answer is in the affirmative, although the extent of the contribution can but seldom be established. Second, did the damage done produce a local shortage of critical proportions? To this question no definite answer is possible. It can merely be suggested that, under prevailing conditions, even a small loss, particularly in the battle area, could well be the straw that broke the camel's back.²⁸

[REDACTED]



Chapter V

OPERATIONS IN AUGUST 1944

The General Situation

The Changing Battlefronts

August 1944 was a most notable month in the invasion of Europe. The extent of the accomplishments is clearly shown by the contrasting situations which existed at its beginning and at its end. On 1 August the territory held by Allied armies was small, although the break-through at St. Lo was being rapidly exploited. The lines ran west and east through positions south of Caen and St. Lo and then dipped south, paralleling the coast a short distance inland as far as the area of Avranches. By 1 September Brittany had been overrun with the exception of its ports at Brest, Lorient, and St. Nazaire, and American lines had reached the Loire from the region of Nantes in the west to Gien in the east. By that same date American forces had crossed the Seine above and below Paris and overrun a great area to the east of the liberated capital. Compiègne, Laon, and Reims had been taken on the northern flank; to the east they had reached the Meuse at Verdun and crossed the upper Marne at St. Dizier; in the south they had occupied the regions of Troyes and Sens. On 1 August the Battle of France was only a week old. On 1 September it was rapidly drawing to a close.



Such were the over-all gains registered on the ground by the Twelfth U. S. Army Group. The most dramatic action was that of the Third Army, which became operational on 1 August. It first drove its mobile columns through the Avranches bottleneck west into Brittany and south towards the Loire, cutting off the Breton peninsula. Then, with startling speed, some of its units swung northeast towards Argentan, tightening the noose about the Norman pocket, while others raced east to Paris and beyond to points within 60 miles of the German frontier. Meanwhile the First Army pushed south from St. Lo and fought to widen the coastal corridor by an eastward advance. In the early days of the month it stopped, in the Mortain region, the German counterattack which was designed to cut through to the coast at Avranches and so sever the communications upon which the Third Army depended. That done, it, with the British, the Canadians, and the Third U. S. Army closed in upon the enemy, and as it swept east to and beyond the Seine, destroyed a large portion of his army in Normandy. The over-all results were phenomenal, and never had the joint responsibility of ground and air for the achievements recorded been more clearly evident. The Ninth Air Force was teamed up with the Twelfth Army Group, IX TAC acted in cooperation with the First U. S. Army, and XIX TAC cooperated with the Third. Throughout the month mediums and fighter-bombers of the Ninth were constantly employed to help win the Battle of France by missions involving air-ground cooperation, whose tactical worth was obvious, and likewise by missions whose bearing upon current operations was equally forceful--missions to

[REDACTED]

isolate the battlefield and to destroy enemy communications and supplies. The Ninth was continuing to function as a Tactical Air Force.

Ninth Air Force Organization and Movements

On 8 August 1944 Maj. Gen. Hoyt S. Vandenberg assumed command of the Ninth Air Force vice Lt. Gen. Lewis H. Brereton, relieved. A new hand was at the helm, but many earlier traditions were maintained, none more vigorously than that set forth in General Brereton's oft-repeated slogan "Keep Mobile."¹

For the proper performance of its tasks, mobility on the part of the Ninth Air Force was a prime requisite. To operate efficiently Ninth Air Force combat units must be based on the continent and as close to the fighting fronts as possible. The movement of fighter-bombers from Britain to France had been begun in June when seven groups became operational on the continent. It continued through July, and by early August all were based in France.² With the rapid advance of the ground forces, changes of location in France were necessary, and movements from the original bases in Normandy and the Cotentin to others in the vicinity of Rennes, Le Mans, Chateaudun, and Paris were effected. Not every move was of immediate advantage. Airfield construction had been planned in accordance with estimated movements of ground forces, which in August advanced at a greater speed and at times in other directions than had been anticipated. On occasion a move might bring the fighter-bombers no nearer the fighting

[REDACTED]

[REDACTED]

than they had been in a previous location, and operational difficulties were often in evidence throughout the month as the front accelerated its eastward movement.³ Mediums had begun to shift from their Essex bases between 18 July and 5 August when the four groups of 98th Wing established themselves in the Bournemouth area. As continental fields previously employed by fighter-bombers became available, these same groups moved across the Channel (16 to 30 August). IX Bomber Command was itself alerted for such movement at the end of the month. Upon its arrival on the continent operational control of the groups based there devolved upon 98th Wing, which was furnished with a list of IX Bomber Command priority targets from which it prepared its missions.⁴

Association of Air and Ground Headquarters

Mobility was likewise demanded of Ninth Air Force Headquarters and headquarters of IX and XIX TAC. It was essential that the operations controlled by Ninth Air Force Headquarters be developed in the closest association with Headquarters Twelfth Army Group, which had immediate tactical command of all American ground forces. Accordingly headquarters at Uxbridge in Britain and at Grandcamp les Bains on the far shore were both closed at 2400, 5 August, and a single headquarters opened at St. Sauveur Lendelin at 0001 on 6 August. It was there placed beside Advanced Headquarters Twelfth Army Group whose G-2 Air and G-3 Air were established in the Ninth Air Force Operations Center. Advanced Headquarters ABAF was located at the same spot. A

[REDACTED]

[REDACTED]

later move (23 August) to a position east of Laval maintained this close association of ground and air, in the main, although the immediate connection with Headquarters Twelfth Army Group was severed.⁵

IX TAC strove to continue its intimacy with FUSA in its successive moves to Canisy (2 August), to Coutouvray (12 August), and to Haine (22 August).⁶ XIX TAC had established an advanced headquarters between Lessay and Coutances on 31 July, in proximity to Headquarters Third U. S. Army (TUSA). In an effort to maintain this association, later moves were negotiated to Beauchamps, east of Granville (3 August), to St. James (7 August), to Les Chenes Secs, north of Laval (15 August), and to Autainville, near the Forêt de Marchenoire, south of Chateaudun (30 August).⁷ If any headquarters was to maintain effective operational control of its components, complete wire communications with them were necessary, but as the armies raced eastward their headquarters moved with almost equal speed and at a rate which air force communications could not hope to equal. This was particularly true of TAC Headquarters. As early as 7 August, therefore, IX TAC constituted a flying column, and XIX TAC an advanced echelon to accompany Advanced Headquarters FUSA and TUSA, respectively. Completely mobile, the operations officers who composed these units maintained contact with the armies and with their own operational headquarters which, perforce, lagged behind. They were powerfully reinforced in their effort to effect full air-ground cooperation by the frequent presence of their respective commanding generals

[REDACTED]

[REDACTED]

at the advanced headquarters of the army with which they were associated.⁸

The association of Ninth Air Force Headquarters with that of Twelfth Army Group was imperative throughout this critical period. At best it was difficult to lay on preplanned missions. Bomb lines established by the armies were difficult to ascertain in days when the front was advancing at great speed and when communications were often improvised or inadequate. Intelligence was often none too plentiful, and the use of the combined resources of air and ground was required for the proper information of both. Moreover, German deception through the use of VHF required the provision of counter-measures and safeguards. Only through the full utilization of all available resources, those of air complementing those of ground, was it possible to plan and execute the extraordinary ground-air operations of August 1944.

IX Tactical Air Command

IX TAC flew 378 missions, aggregating a total of 12,305 sorties in the month of August 1944.⁹ The records for the period use the phrases "Armored Column Cover" and "Armed Reconnaissance" as descriptive titles for the greater part of these missions, the balance being special tasks undertaken at the direction of superior headquarters or at Army request. With very few exceptions, the areas or targets assigned to all missions lay west of the Seine or north of the Loire. Moreover, by far the greater part of these areas and

[REDACTED]

[REDACTED]

targets were within or very close to the battle lines of the moment, notably as the lines drew nearer the great rivers. All operations were of a tactical nature, but because of the above facts it is difficult to distinguish between those which should be classed as direct air-ground cooperation in association with the battlefield effort of ground troops and those whose tactical relationship with such effort is to be classed as indirect rather than immediate. Such distinctions must, however, be attempted.

Armored Column Cover in August

Armored column cover missions, obviously involving close cooperation with FUSA's operations, were flown on 21 days of the month, aircraft from one to four groups being assigned each day. Largely because the GAF tended to be more aggressive than in the earlier period, eight aircraft now constituted the usual patrol, remaining in the area for one and one-half hours and conducting reconnaissance some 20 miles in advance of the column when requests had been accomplished or if no requests were forthcoming. The techniques earlier employed were continued and perfected. In one case the A-3 of 368th Fighter-Bomber Group spent five days with the 3d Armored Division in order that the latter's selection of appropriate targets for air attack might be improved. Towards the end of the month, as the distance separating air bases from the heads of columns increased, aircraft on armored column cover had to employ belly tanks in the execution

[REDACTED]

[REDACTED]

of their missions.¹⁰ A few examples serve to indicate that, as previously, these missions were effective.

The most notable of these occurred on the second day of the month when "Foodie" (a combat command of 3d Armored Division) was held up by guns in buildings northwest of Mortain. Aircraft of 368th Fighter-Bomber Group were called upon to bomb, which they did, scoring direct hits which allowed the column to proceed. It was again held up at the next town, St. Barthelamy, but escorting aircraft again blasted the fortified positions and received their reward in seeing our armor enter Mortain at 1815 hours. On 5 August ground requested that both ends of a bridge be bombed to explode mines, but asked that the bridge itself not be attacked. This was done. The next day a mission bombed a road northeast of Vire and destroyed a steeple (possible CP), an antiaircraft emplacement, and other gun positions. On 7 August planes of 368th Fighter-Bomber Group bombed woods south of Brecey and produced a terrific explosion. "Murphy" (2d Armored Division) then directed them against 88-millimeter guns located in woods. The results were good, since many gun flashes were seen in the area before the bombing and none after it. "Murphy's" report was that the aircraft had done a fine job. The following day aircraft of 366th FB Group distinguished themselves when one formation destroyed 5 tanks and damaged 8 others, and another claimed 12 tanks, 8 M1 (5 carrying ammunition), 5 horse-drawn vehicles, and 3 horse-drawn flak guns. The crews of six flak guns on a road west of Mortain were wiped out by one formation on the 9th; another on the 10th attacked

[REDACTED]

[REDACTED]

gun positions near Sourdeval, which ground forces knocked out so completely as to deserve commendation. On 15 August aircraft of 404th FB Group, escorting the 3d Armored Division, twice bombed the town of Ranee at ground's request, and strafed near-by roads with marked effect. A single formation listed 15 tanks, 4 armored vehicles, and 2 gun positions among its claims; while the claims of the 11 formations of 404th FB Group, which furnished "flying interference" during the day, totaled 29 tanks, 12 armored vehicles, 5 half-tracks, 35 MT, and 5 gun positions destroyed. The following day a formation affording cover destroyed two tanks, 11 MT, and an ambulance which was towing an 88-millimeter gun. Fifty MT were claimed by an escorting formation of 368th FB Group on 25 August. On the 27th 16 of 404th FB Group's P-47's engaged in escort were jumped by over 40 enemy aircraft. Their claims were 11-4-1 for a loss of four. Other armored column cover missions produced less striking effects individually, although the aggregate result of the sustained endeavor was great.

Air-Ground Cooperation, 1 to 7 August

Many area missions described as armed reconnaissance, many others undertaken as the result of joint plans developed by IX TAC and FUSA, and such few as were flown in this period at the request of Army corps and divisions likewise fall under the heading of direct air-ground cooperation. In these missions pilots had to exercise unusual care in bombing as the month of August wore on. On the one hand, enemy pockets of resistance remained within territory which was for

[REDACTED]

[REDACTED]

the most part occupied by American troops, while on the other hand friendly units were operating deep in enemy territory. "Know your target before you hit it" became the current motto by prescription. Selected examples must again serve to exhibit the nature and the results of these activities.

Air-ground cooperation missions of this type were but few in the first week of August since most armed reconnaissance was concerned with areas somewhat removed from the existing battle lines. However, on the 4th, ground control directed one armed recon against four tanks, two of which were destroyed. The remaining two were damaged and troops strafed. On the same day "Murphy" gave another armed recon a target in the shape of a troop concentration in woods southwest of Vire. Twenty-four bombs fell in the area and produced a large explosion. On 7 August a divisional command post at Vengeons was hit as requested by XIX Corps, which marked the target with red smoke.

Air-Ground Cooperation in Critical Days, 8 to 14 August

Air-ground cooperation missions on the part of IX TAC became an outstanding feature of its operations beginning with 8 August. On the night of 7-8 August the enemy launched his counterattack from the Mortain area with Avranches as its objective. This action, designed to cut the American communications in the bottleneck, had been determined on the 4th. It was vigorously pursued in the days which followed, but the joint resistance of ground and air was such that on 14 August the enemy was forced to plan a general withdrawal, and on

[REDACTED]

[REDACTED]

the 16th to order retirement beyond the Orne.¹¹ British armies joined in the Allied countermeasures, and RAF's 3d Tactical Air Force likewise cooperated.

IX TAC exerted its maximum effort in the battle area. In the seven days 8 to 14 August it flew a total of 4,012 sorties, nearly all of them in direct air-ground cooperation. On the 12th, 675 were flown, dropping 310.8 tons of bombs. Daily claims, most of them derived from actions in the battle area, stand in direct relation to the effort expended and the targets offered. For example, on 8 August 532 sorties resulted in the destruction of 47 tanks and 122 MT; on the 13th, 649 sorties accounted for 106 armored vehicles and 570 MT; and on the 14th, 614 sorties gave rise to claims of 56 armored vehicles and 348 MT destroyed. Fourteen squadron-strength missions in the La Ferte-Falaise-Argentan area claimed 18 tanks and 70 MT on the 13th. The actions of individual groups possess a like interest. On 14 August 72 aircraft of 368th FB Group claimed the destruction of 5 tanks and 94 MT; on the 16th, 30 aircraft claimed 16 tanks and 53 MT; while the next day 40 aircraft listed 24 tanks and 37 MT among the enemy materiel destroyed. One mission by the 366th FB Group in the Argentan area demolished 6 tanks, damaged 4 others, and destroyed 12 MT on 12 August, while a squadron of 368th Group destroyed two guns towed by ambulances near Ger, and then at "Murphy's" direction bombed the town and left it burning. That same day the 366th Group's claims of 8 tanks, 5 self-propelled guns, 1 gun

[REDACTED]

[REDACTED]

emplacement, and 89 MT earned a commendation from the Commanding General, IX TAC. A formation from the same group did a notable job the following day (13 August). It first sighted two trucks under trees on a road near Carrouges and almost immediately noted what appeared to be trees in the middle of the road. Closer examination disclosed that some 30 gas trucks were parked in the area, and that at least six tanks were refueling from them. The area was both bombed and strafed; fires appeared along a line one and a half miles long, and explosions of ammunition trucks were observed.

In accordance with the joint plans of IX TAC and FUSA three gun positions and two tank concentrations in the Sourdeval-Mortain area were attacked on 8 August. A total of at least 14 guns and six tanks were claimed destroyed. At the request of VII Corps a troop concentration near Juvigny was attacked on the 9th, and bombs fell in the smoke-marked target area. The next day a request by VII Corps for the bombing of tanks and MT west of Sourdeval was answered with resulting fires in the area attacked. On 12 August the 2d Infantry Division requested that some five infantry positions be dealt with. All were attacked with reported results of "good" or "excellent."

In this same period (8 to 14 August) IX TAC and FUSA planned air attacks on road junctions in the Eiers-Domfront-Mortain-Sourdeval area. On the 9th four such targets were hit with bombs carrying the usual fuzes. In the evening attacks against like targets on each of the four following days, some instantaneous fuzings were employed, but

[REDACTED]

[REDACTED]

for the most part the bombs were armed with fuzes providing delays of from six to 12 hours with the hope, as when such fuzings had been previously used, of impeding enemy movement at night. Several targets were assigned to each of the missions thus flown in at least squadron strength. Four took place on the 10th, four more on the 11th, three on the 12th, and one on the 13th. The origin and the location of the targets of these missions cause them to be recorded here rather than under the heading of interdiction.

Some unusual direct air-ground cooperation missions were flown in this period. Aircraft of IX TAC, flying escort to the C-47's of IX TCC which sought to resupply the 2d Battalion of 120th Infantry Regiment isolated east of Mortain on 10 August, incidentally scored hits on three enemy gun positions. The following day a squadron of P-47's themselves dropped supplies. On 14 August 3d Armored Division requested that plasma be dropped for the use of one of their advancing units. Within two and one-half hours after the origin of the request the plasma was dropped and pilots saw it picked up by U. S. ground troops.

Air-Ground Cooperation, 15 to 31 August

Direct Cooperation

The developing ground situation determined that direct air-ground cooperation on the part of IX TAC should continue as a prominent feature of its activities during the remainder of the month (15 to 31 August). The German lunge against Avranches had been stopped and

[REDACTED]

[REDACTED]

Allied countermeasures threatened to annihilate his armies in Normandy. The advance of the Third U. S. Army to the vicinity of Argentan, coupled with the British movement south in the Falaise area, steadily narrowed the only corridor through which enemy troops west of those points could hope to escape from the pocket thus created. By 17 August a fighter-bomber pilot reported that "the whole goddam German Army was moving through this gap," while the pocket had been so reduced that bomb lines within it were eliminated. Two days later, patrols of the 90th U. S. Infantry Division and the Polish Armored Division, operating with the Canadians, met. The pocket was mopped up in the days which followed, and Allied armies, advancing to the east, crossed the Seine at Mantes-Gassicourt and at Vernon by 23 August and compressed the remnants of the German forces in Normandy into a narrow area on the west bank of the Seine between Vernon and the sea.

Armed Reconnaissance

In this period, 15 to 31 August, armed reconnaissance missions were of frequent occurrence and the areas assigned usually lay within the battle zone or in its immediate rear. The "Deep" area assigned on 17 August ranged from Mantes-Gassicourt to Houdan to Breteuil, and hence lay west of the Seine. "Seine River Area" is the title employed in describing armed recces on 18 August and later. Not until the end of the month were areas assigned east of the Seine-Beims-Herpy-Juvincourt; those of Rouen-Beauvais-Soissons were prescribed on 27

[REDACTED]

[REDACTED]

August, and Amiens-St. Quentin-Compiègne-Beauvais on the 31st. The tangled transport of the disorganized enemy columns and their means of escape across the Seine constituted the chief targets for IX TAC's fighter-bombers in a constantly shrinking area. IX TAC's total claims of 612 IAF destroyed on 17 August, 419 on the 23d, and 227 and 294 on the 28th and 31st, respectively, indicate the extent of damage done on days when the hunting was particularly good. Armored vehicles were also hard hit--72 were claimed destroyed on the 15th, 34 on the following day, 69 on the 25th, and 24 on the 28th.^{11e} On 15 August one formation of 367th FB Group assisted tanks shelling Le Tremblay le Vicomte by bombing the town; while another, blocking a column of 30 vehicles and tanks by hitting its head and tail, scored 24 hits. Barges on the Seine or its tributaries appear in the claims of 18 August, when some 17 formations over the Seine River Area reported 58 barges, one lock, and a pontoon bridge (Les Andelys) destroyed. On the 20th seven missions of squadron strength accounted for 13 barges and damaged docks and a steamer. On the same day, and once again in the Seine area, an unusual episode occurred when 75-plus IAF marked with the Red Cross symbol were seen clustered about a ferry terminal near Venables on the west bank. They were first identified as military vehicles, and then bombed and strafed. Black smoke and violent explosions proved that the identification was correct. Ferries and their terminals were also hit on the 23d and 25th. It is noteworthy that on occasion leaflet bombs were dropped on the pocket and on the withdrawal areas (e.g., 15, 18 August) in the hope of lowering enemy morale.

[REDACTED]

[REDACTED]

Air Strikes on Communications Targets

Attacks on specified communications targets supplemented armed reconnaissance and were, in most cases, of a nature which causes them to be rated as air strikes in air-ground cooperation. Five MT were destroyed by Napalm on the road between Briouze and Falaise (16 August). An attack on the bridge at Tbcuf (18 August) resulted in four hits on the approaches. A bridge under construction over the lower Seine was heavily bombed (22 August) with 15 hits reported in the target area; and a new wooden bridge near Oissel was destroyed (25 August), together with 50-plus MT which stood bumper to bumper. Earlier (20 August) six squadron-strength missions had dropped delayed-action bombs on Seine ferry crossings which the enemy was using at night.

St. Malo and the Ile de Cezebre

Direct air-ground cooperation on the part of IX TAC was further in evidence in the reduction of St. Malo and the Ile de Cezebre. On 17 August 35 planes of 370th FB Group dropped two Napalm bombs on the citadel before they received word from ground that its surrender had been effected; they then delivered the balance of their load on the obstinate Ile de Cezebre. Again on 31 August IX Tactical Air Command attacked the latter stronghold, this time as part of an air, ground, and sea attack which had been carefully coordinated. Mediums of IX Bomber Command and Lancasters of RAF Bomber Command opened the aerial assault as H.M.S. Warspite, covered by planes of

[REDACTED]

[REDACTED]

50th FB Group, delivered salvos of 15-inch armor-piercing projectiles. At intervals field artillery directed the fire of 165's and 8-inch and 240-millimeter guns at embrasures, ports, and tunnel entrances. Finally, 33 P-38's of 370th FB Group rained down Napalm bombs. G-3 Air of Twelfth Army Group reported that veteran artillerymen were lost in admiration as the Ninth Air Force planes circled the target, waited for the smoke to clear, and then peeled off and bombed. At 1800 a demand was made for the island's surrender, but no capitulation resulted until 2 September, since the German commander lacked the necessary permission of higher headquarters.¹²

Other Tactical Operations

The above narrative of IX EAC's effort by way of air-ground cooperation in direct relationship to the ground effort indicates that such actions absorbed the bulk of its resources and energies throughout August 1944. Certain other activities must, however, be recorded to complete the picture. They, too, are tactical in nature and related to the ground effort, but their connection therewith appears to be rather less direct than the actions already chronicled. Their purposes were varied: to destroy enemy materiel, particularly by the attrition of his critical supplies, to disrupt his powers of command by attacks on headquarters, to delay his retreat, and by continued attacks so to harass his personnel as to reduce their morale.

Transportation Targets

During the first week of August missions in the nature of armed

[REDACTED]

reconnaissance occasionally carried aircraft of IX TAC as far afield as Cambrai, Soissons, Nevers, and Poitiers (1, 2, 4, 5 August). Some damage was done to rail targets, as when the locomotive and 10 cars of a troop train were hit and tracks cut in the St. Cyr-Orleans-Nevers area and when three trains were destroyed near Saumur (5 August). Again in the closing days of the month some armed reces flew to the east of Paris. On 27 August two missions in the Reims-Beauvais-Soissons area listed 117 and horse-drawn vehicles, together with 13 barges among their claims. A third mission in the same area and on the same day concentrated on rail targets and claimed three locomotives and 50 cars destroyed, while a fourth claimed the destruction of over 100 tank cars in the yards at Chantilly. On 31 August two missions, each of group strength, in the Arians-St. Quentin-Beauvais area claimed 123 117, 9 armored vehicles, and 92 horse-drawn vehicles as their contribution to the afflictions of the retreating enemy. Such actions as these were obviously related both to the activities of American ground forces and to the interdiction program.

Dumps

In an effort further to cripple the enemy, IX Tactical Air Command continued to attack fuel, ammunition, and supply dumps. Attacks on fuel distribution points had the greatest significance because the Eighth Air Force was engaged in bombing the sources of such supplies. In the opening days of the month dumps at Domfront, Rennes, and Angers, and in the vicinity of Orleans, Tours, and Troyes were attacked with

satisfactory results (1, 4 August); while the familiar targets in the Foret d'Andaine were hit again (6 August) with no results observed. In the period of the German counterattack further missions were directed against like targets on each day from 8 through 13 August. Dumps in the Domfront area, in the Foret de Coevran, Foret d'Ecouves, Foret d'Andaine, Foret de Senonches, and Foret de Rambouillet were hit, as were others east of Dreux and near Maintenon and Briouze. On 22 August supply dumps in the Foret de Bretonne were attacked and fired. As a rule the missions were of squadron strength. Exact results could not be determined, although some explosions and fires were produced.

Airfields and Aerial Combat

Attacks on enemy airfields were in order in August because of the increased activity of the GAF. Runways were damaged and fires started at Beauvais-Tille (18 August). Dispersals, buildings, or runways were hit in attacks on fields at Laon-Athies, Laon-Chambry, Juvincourt, and Clastres, and on another near Roye in attacks which destroyed a total of nine enemy aircraft in the air and 10 on the ground (22 August). On 25 August IX TAC delivered exceedingly powerful blows east of Paris and likewise south of the Loire. Three squadrons of 379th FB Group were dispatched against airfields in the St. Quentin area. Hangars and runways were hit on several fields, but more important were the claims of 20-3-6 in air combat for a loss of seven. Two squadrons of 474th FB Group, sent against the fields

at Terguies, Laon-Chambry, and Herpy, engaged in air combat also. They lost a total of 11 planes against claims of 21-3-15. On the same day action was taken against fields at Cognac and Dijon, which the enemy was known to be using for the evacuation of troops caught between the American Third and Seventh Armies. At Cognac two squadrons, one from the 365th and the other from the 367th FB Group, destroyed 12 enemy aircraft on the ground. Ten were troop-carrying JU-52's. A squadron of 370th FB Group and another from the 367th attacked Dijon, destroying 21 enemy aircraft, including 20 JU-52's on the ground, and damaging three. The total claims of IX TAC for the day were thus 41-6-21 in the air and 21-0-3 on the ground, for a grand total of 62-6-24. Such claims, coupled with the steady maintenance of armed reconnaissance and armored column cover, help to explain our overwhelming air superiority. Not the least of the results which were derived from this was the uninterrupted flow of reinforcements and supplies over the roads from the beaches to the fighting lines. The roads were of necessity crowded, and offered ideal targets for attacks from the air which seldom materialized. That they did not was one of the miracles of the Battle of France. Airfields in the Dijon, Bourges, and Cognac areas were again hit on 26 and 27 August with total ground claims of 22-0-4, while damage was inflicted at Peronne, Eoye Amy, and Rosieres on the 28th.

Enemy Headquarters

On occasion information gathered by intelligence caused IX Tactical Air Command to deliver attacks on enemy headquarters. Two

such attacks, made in the month of August, were notable. On the 25th what was reputed to be von Kluge's headquarters at Verzy, southeast of Reims, was hit with 24 Napalm tanks and left burning furiously. Its personnel may, however, have found safety in near-by caves. Earlier (17 August) three squadrons of 474th FB Group attacked as many pinpointed targets in a Gestapo headquarters near Chateauroux, south of the Loire. Bad weather prevailed as the strikes were delivered, but pilots' reports of the bombing and strafing were enthusiastic, recording damage to structures and personnel, and listing two hits on the front door of the main building. Later reports from the ground indicated that those claims were fully justified. Four buildings on an airfield and two chateaux were demolished, as were a station used for headquarters passing through, and a motor park containing some 200 vehicles. German personnel suffered severe casualties. Headquarters FUSA extended its thanks and congratulations for the mission which it described as a complete success.¹³

Recapitulation

Weather had an adverse effect upon operations of all types during the month. On three days (21, 29, 30 August) no operations were possible. Operations were frequently restricted on others, particularly when night dew was transformed into ground haze or fog over bases or in target areas. But the situation was such that missions were flown whenever there was any chance for their execution. The 673 sorties of 12 August constituted the month's high; the 161 sorties on the 19th was the low for the period. As previously remarked, the total

sorties by IX TAC in August reached the notable total of 12,305. Its effort, in which air-ground cooperation figured so prominently, was marked by the loss of 123 aircraft and by the month's total claims of 63-2-19 enemy aircraft on the ground and 98 $\frac{1}{2}$ -18-35 in the air.¹⁴

XIX Tactical Air Command

The association of XIX TAC with Third U. S. Army (TUSA) was as intimate as that of IX TAC and First U. S. Army (FUSA). To an even greater degree than in the case of IX TAC, the missions of XIX TAC, under the command of Brig. Gen. Otto P. Weyland, were in direct air-ground cooperation. The problems involved were enormous. Technical difficulties in maintaining communications between ground and air units were frequently in evidence. Armored columns split up into two or more combat teams, thereby making demands for Air Support Parties beyond anything envisaged in air force T/O's. Notably after General Patton's columns turned eastward on 6 August and began their famous "end run," the rapid advance of the battle lines gave rise to the new problems concerning the location of headquarters, as was mentioned above, and left air bases so far to the rear that aircraft were often forced to operate at extreme range, returning to base with tanks nearly bone-dry or refuelling at a forward field before completing their missions.¹⁵ In spite of all difficulties, however, the achievements of XIX TAC were on a grand scale.

Three groups of fighter-bombers were available when XIX TAC became operational on the continent on 1 August. By the 5th a total of five groups was under its control, and by 7 August, nine. In the course of the month 12,292 sorties were flown, an average of 439 for each of the 28 operational days. On a single day (9 August) 72 missions were flown which involved 780 sorties, and on only three days (1, 24, 28 August) did the total sorties made fall below 200.¹⁶

Characteristic Activities, 1 to 7 August

The very nature of the operations involved in direct air-ground cooperation precludes the possibility of rendering a complete and accurate report upon them. The fleeting nature of fighter-bomber attacks, the indistinct quality of the targets, and the smoke and dust incident to the attack all contribute to such a result. Once again we must depend upon available examples to indicate the nature and effect of such action.¹⁷

During the first week of its association with TUSA, XIX TAC provided excellent samples of the work it was to do throughout the month in direct air-ground cooperation. Flying cover for the 2d Armored Division in the Tassy area, two flights of 362d FB Group destroyed a total of seven tanks, damaged another, and silenced six gun positions on 1 August. Rockets of 406th FB Group destroyed two tanks and two four-gun batteries on the 2d, while its bombs covered a smoke-marked target west of Wire with results unobserved. On 3 August, also, 363d FB Group flew five eight-plane missions to cover

the Avranches bottleneck, while with a view to protecting communications between the advancing columns and that vital area, aircraft returning from armored column cover were directed to make periodic sweeps over the rear of their columns and in the direction of Avranches. On the 3d an element of 405th FB Group was vectored to a road south of Rennes which it bombed and strafed, destroying 22 MT and four horse-drawn vehicles. A squadron of 373d FB Group destroyed an AAA position north of Rennes on 4 August, and on the following day 11 missions by eight aircraft each of 405th FB Group claimed as destroyed 54 MT, 9 horse-drawn vehicles, and 3 self-propelled guns. On the 5th, likewise, 358th FB Group reported that American troops were storming into Mortain from the west. Two elements of 405th FB Group accounted for 13 tanks and 8 MT by rocket fire and for another 16 MT by strafing on 7 August. On the same day, 363d Group flew 15 armored column cover missions over the Brest peninsula, bombing an ammunition convoy sheltered in woods at Plonagot. Reports of such characteristic activities fill the "Opdocs" for the balance of the month. Transport and strong points, tanks and gun positions, smoke-marked areas, and others designated by pin points were under constant attack by XIX TAC in the course of the 28 operational days in August 1944, and reports of the positions of friendly and enemy troops were regularly submitted.

The scale of this effort was notable: 363d Group flew 7 such missions on 4 August, 15 on the 7th, 13 on the 8th, and 15 on the 9th. On 4 and 5 August, 11 such missions were flown by 405th FB Group.

followed by 17 on 14 August and 15 on the 15th. The ordinary effort was two group missions per day, or six squadron missions or 72 sorties.

Techniques and Problems

Cover for the armored columns was furnished by elements of from eight to 12 aircraft, relieving one another in rotation. On arrival at the designated area, the leader checked in with the flight leader being relieved and also with the Air Support Party on the ground. The relieving element was then ready to act on information received from the ground, and to carry out the standard operating procedure of patrolling ahead to a distance of 35 miles to seek out the enemy, to attack suitable targets, and to report his positions to the armored column. The number of aircraft employed and their bomb load varied with the amount of enemy armor opposing the movement of the American column and the possibility of encountering enemy aircraft. For example, in the area between Le Mans and Fontainebleau, where few thick-skinned enemy vehicles were encountered, it was possible almost to dispense with carrying bombs, since the desired results could be obtained by strafing. Armor-piercing incendiary ammunition was found to be the most effective for strafing, as for other purposes, and experience proved that tanks could be set on fire by strafing attacks from the rear. In the Montre-Cassicourt region, close to Paris and the enemy's fighter fields, only one-third of our aircraft were bombed up because of the frequency of encounters with enemy aircraft. The damage inflicted by intense light flak over concentrations of enemy

~~CONFIDENTIAL~~

troops rendered operations under 3,500 feet impracticable. For dive bombing a 5,000-foot ceiling with broken cloud was required. The effective radius for the P-47 with full bomb load but without spare tank was 200 miles. The spare tank (150 gallons) increased this distance to 350 miles. For the P-51 the radius was 325 miles on fighter sweeps without tanks, or about 600 miles with it. The most frequently employed loading was two 500-pound GP bombs with instantaneous fuze. This bomb was suitable for use against most military installations not protected by reinforced concrete or masonry. For rail cutting an eight- to 11-second delay-fuze was employed. Frag clusters and 300-pound frags were on occasion employed against personnel and thin-skinned vehicles, notably against the concentrations in the Argentan pocket. Napalm, placed in belly tanks provided with a detonator and dropped from minimum altitude without the use of a sight, was infrequently though profitably used.

Communications with the ground were often difficult and at times impossible--crowded channels, poor reception, and excessive "chatter" being frequently reported; but this situation was improved by a re-assignment of frequencies. The enemy at times sought to confuse the situation by giving false directions to divert or to trap American aircraft. Demands for authentication usually disclosed the true nature of the sender, as in the extreme case where the enemy was asked--and failed--to sing "Mairzie Dotts."¹⁸

It is not to be assumed that uniform success attended all missions. Random examples from the experience of 388th FB Group indicate that

~~CONFIDENTIAL~~

results varied greatly and that they were at times disappointing. On 9 August this group dispatched 11 squadron-strength missions on assault area cover in the Le Mans-Laval-Fougères region. In eight instances contact was established with the ground. In one case the indicated target could not be discovered, in another lack of fuel prevented investigation of the designated area. In four cases no targets were given to the covering planes. Furthermore, one of the squadrons--the last dispatched in the course of the day--was recalled, while seven brought their bombs back to base although planes from one of these (probably those assigned to escort and hence not carrying bombs) strafed horse-drawn artillery. Two enemy tank elements were, however, bombed; and gun positions were bombed and strafed in the course of the three other attacks delivered that day. On 23 August 358th Group flew eight missions to afford close cover to the 5th Infantry and 7th Armored Divisions in the area Etampes-Fithiviers-Montereau-Melun. Contact with ground was made in at least five cases, but again lack of fuel prevented search in one instance, while in another the given target was not located. One mission was recalled, one was reported uneventful, and bombs were returned to base by four others. Three missions attacked, their crews reporting direct hits on designated gun positions and on a supposed concentration of enemy troops, together with the strafing of tanks and horse-drawn artillery. In this connection, however, certain facts should be observed: first, that covering aircraft were available when needed; second, that when lack of fuel prevented investigation of an attack upon a designated target by

one squadron, the task could be passed on to that which relieved it; and third, that the constant presence of American planes in the assault area for the moment was a source of encouragement to our ground forces and provided them with a sense of security, while the effects upon the enemy were the exact opposite. Even when no air strikes were delivered, the aircraft of XIX TAC were serving the cause of direct air-ground cooperation.

Air-Ground Cooperation, 8 to 31 August

As has been frequently noted, air-ground communications were an essential to effective air-ground cooperation in the assault area. The brief narratives in the "Opregs" of the period are often inconclusive on this score. At times they report that contact was made and attacks delivered on a given mission, but do not specify that the targets were those designated by ground. In other cases they record attacks but do not mention ground contact, although such may well have been established. Accordingly such instances as exist which clearly indicate ground control of air-ground cooperation missions possess an unusual value since they establish the fact that highly significant results were obtained when communications worked well and when appropriate targets existed and were found. Examples of such action have added interest because of the types of situations or targets involved, the reported efficacy of air operations, and the techniques employed. Those given below are merely illustrative. They do not claim to be inclusive.

On 8 August a formation of 371st FB Group had bombed and strafed tanks east of Mortain when control referred them to a P-51, which led them to tanks and half-tracks under hedgerows in the same area. These were bombed and strafed, though with unobserved results. Two days later the same group was providing escort for XIX Corps in the vicinity of Angers. One of its formations was directed to a target reported to be horse-drawn artillery in woods; upon reaching the target, it discovered stationary trucks, which it bombed and strafed, reporting five destroyed. On the 10th, as the Argentan trap was being closed, ground vectored an element of 358th FB Group to tanks near Marolles: two of the six were left smoking as the result of direct hits. During the continued heavy fighting about Mortain on the same day "Murphy" asked a formation of 362d FB Group for an attack on 14 mortar positions north of the town. Fourteen 500-pound GP bombs completely silenced the position and drew the comment from ground that the results were the best ever achieved in air-ground cooperation.

Actions on 11 August afford further examples of effective operations. A squadron of 358th Group was giving cover in the Nantes-Angers area when it was vectored to woods southwest of Redon. Troops were seen running from the woods following the dive-bombing attack, which fact, together with the nature of ground fire received, suggested that an enemy concentration had been hit. As the result of a ground request received at XIX TAC Combat Operations, 303d Wing vectored a squadron of 358th Group to a railway gun which was holding up the

5th Infantry Division near Angers. Forty minutes after the request was received, direct hits destroyed the target. A squadron of 36th FB Group was informed that armored units were holding up our advance east of Alencon. Bombs dropped in the target area at St. Remy du Plain destroyed four tanks and the town was strafed with results unknown. Another squadron of the same group spotted an enemy convoy southeast of Sees. Ground authorized the attack which destroyed nine tanks and 24 MT. Other squadrons of 36th Group were similarly active the same day. One was given targets northeast of Alencon by ground control and in a series of attacks claimed five tanks destroyed and eight damaged, the most notable results following an attack of a 10-tank column which was first blocked on the road and then bombed and strafed. A second squadron was informed that an American column was held up by a Tiger tank northeast of Alencon. Fifteen 500-pound GP bombs were dropped in the area--"resistance eliminated. Column advanced."

On 12 August a squadron of 371st FB Group, returning from bombing the Forêt de Perseigne, was asked by ground to attack two convoys east of Argentan. Both were strafed with total claims of some 57 MT, 2 half-tracks, and 3 light armored cars destroyed. In Brittany on the same day a formation of 358th FB Group was directed against a troop concentration in St. Gildas des Bois, and one of 354th FB Group to another near Paimpol. Both targets were hit. Squadrons of 373d FB Group operated in the Argentan-Falaise-Alencon area on 13 August. "Poodle" called upon one of them to eliminate a gun position

west of Alencon which was holding up a column, and "perfect team work with the flight destroyed the gun." Later (17 August), as American columns advanced through Dreux toward Seine crossings near Vernon, a flight of 362d FB Group was directed against enemy infantry and antitank positions at a road junction north of Dreux. Artillery marked the position with smoke. Bombing and strafing followed and while trees and hedgerows denied observation of results to the air, ground forces congratulated the flight leader on silencing the guns.

Ten Tiger tanks at the Seine crossing near Bonnières were smoke-marked for attack by a formation of 371st FB Group on 19 August; bombs delivered in the raid fell in the target area with no results observed. The 20th saw the battles west of the Seine from Mantes-Gassicourt to Vernon develop in intensity, with air making a substantial contribution to their success. Ground directed one flight of 358th FB Group against vessels ferrying trucks across the Seine. Their bombs missed one such ferry, but damage was inflicted by a strafing attack. Another element was vectored to an area where a tank battle was raging in the bend of the Seine near Moisson, and there damaged two tanks. A third was sent against four smoke-marked tanks at La Feuillère (west of Vernon), where three bombs destroyed one tank and damaged two others. A fourth attacked a machine gun nest and claimed damage to five tanks. On the same day a flight of 362d FB Group checked Seine crossings west of Mantes at ground's request and was subsequently sent by another controller to bomb the town of Pacy

sur Eure and three tanks in a nearby orchard. The town was bombed and then extensively strafed, while the tanks were found and one left ablaze. Another formation was vectored to the spot, and other flights of the same group were called upon to attack tanks west of Vernon. One bombed and strafed two with unobserved results. Another's mission was properly reported in greater detail. Ground had given the eight-plane flight a target of tanks which opposed elements of the 5th Infantry and 7th Armored Divisions. At the target the aircraft found American troops on one side of a wood with six well camouflaged enemy tanks in orchards and a town beyond. The flight leader searched the targets at very low altitude and directed individual planes to attack. Bombing destroyed five tanks, and strafing accounted for the sixth. On 23 August tanks were assigned to two elements of 362d Group between the Eure and the Seine to the east of Authueil. One squadron found a single smoke-marked tank and damaged it; the other found two, destroyed one, and damaged one. The same day 18 camouflaged tanks in woods east of Evreux were designated as the target for another squadron of the same group; it dropped three 500-pound GP bombs and six frag clusters in the target area with unobserved results. Again on the 23d, squadrons from 362d Group furnishing cover in the Chartres area attacked convoys. Ground cleared one such target for attack west of Fontainebleau, and directed that the other east of Sens be attacked. Claims of 32 MT destroyed resulted. On 25 August "Beagle" (4th Armored Division) directed a formation from 371st FB Group to a retreating German convoy east of Troyes from which was

exacted a toll of 25 MT destroyed and 18 damaged. On the succeeding day planes of 403th FB Group were given a like target in the same area, now congested with fleeing enemy vehicles. They destroyed 20 MT.

On several occasions aircraft of XIX TAC were asked by ground units to act against enemy planes which were over our lines. Although the attacks were not heavy and countermeasures were not always successful, they deserve recording. American trucks under attack southwest of Avranches on 2 August asked action from a formation of 362d Group. It answered the call and discovered two ME-109's, which, however, escaped into the surrounding haze. On the 22d, planes from the same group responded to a call from the ground in the Vernon area where German strafing planes had left before ours arrived. Our formations had better luck on three other occasions. Once again it was an element of 362d Group which was vectored to two enemy aircraft over our lines at Le Mans. One was destroyed, and the 79th Infantry Division, which had caused friendly AAA to hold its fire during the encounter, voiced its thanks. Two enemy aircraft of those diving in the Dreux area, to which a formation of 371st FB Group had been vectored, were destroyed on 19 August. Finally, 362d Group reappeared upon the scene on the 23d in the region of Sens. The group had just bombed a gun position at St. Florentin when "Beagle" reported that it was being strafed near Villeneuve. 362d Group jettisoned the balance of its bombs, flew to the attack, and in the encounter which ensued with five ME-109's claimed 2-1-0.

The instances above cited of direct air-ground cooperation when ground requested that attacks be delivered against targets which it had selected or approved, coupled with the examples drawn from the first week of XIX TAC's activities, must serve as illustrations of the general run of its air-ground cooperation in the month of August. The number of such missions flown is so great as to forbid that all be narrated. Their number, and the manner in which they reported, do not justify the elaborate work of compilation that would be required to present an inclusive summary. Accordingly it remains only to mention a few episodes which, because of success achieved or because of the unusual nature of the target attacked, should appear in a narrative of air-ground cooperation for the month.

The advance of ground troops in this period moved at so swift a pace as often to outrun their own communications and to cause air to contact its assigned ground force at a point some miles in advance of that fixed for their rendezvous. Air reports of the position of friendly troops were therefore much to be desired and were frequently given in the formal reports which constitute our source of information. A few selected examples will illustrate the point. On 15 August 363d FB Group noted a steady stream of Allied vehicles moving towards Chartres. On 20 August 358th FB Group reported that our troops were entering Vernon. On the 27th the report of 36th FB Group included the remark that American troops were moving from the Sens area toward Troyes along every road. Such details are relatively

unimportant now. In the days of August 1944 when they were reported, they might contain information supplementing that of tactical reconnaissance and ground intelligence and of great worth to air and ground alike.

The area of air-ground cooperation was that of the current battle front. But on occasion covering planes might sweep the region beyond it. For example, a formation of 371st FB Group, assigned to cover the XIX Corps in the vicinity of Angers, attacked a column of horse-drawn artillery and troops south of the Loire at that point on 10 August. The case is of greater interest because on the 6th, General Weyland, in conference with General Patton, had assumed the task of protecting the Third Army's southern flank as its columns raced eastward merely occupying key cities along the Loire. Here was an instance where air acted against a possible danger to that flank. Examples of such action south of the Loire are few, for as the invasion of southern France progressed, the main task which devolved upon XIX TAC was to conduct some armed reconnaissance and regular tactical reconnaissance south of the river. Tactical reconnaissance could spot movements; armed reconnaissance could help prevent their combining into a real threat.

Unusual results attended some missions over the battle zone. A three-squadron mission by 26th Group in the Argentan area came upon 300 to 1,000 vehicles standing on the roads on 13 August. The entire group strafed and reported the destruction of 400 to 500 (a dropped belly tank destroyed 12), while another squadron in a later mission

in the same area destroyed 50. Three squadrons of the same group found MP bumper to bumper on the roads about Argentan on the 18th and claimed the destruction of 77. The target was again unusual on the 27th, when one squadron of 36th Group struck road targets east of Nogent and northeast of Meaux with total claims of 20 horse-drawn vehicles, 8 pieces of horse-drawn artillery, 14 MT, and 3 tanks destroyed; while another claimed 13 horse-drawn artillery pieces, 8 tanks, 25 MT, and 52 ammunition wagons in its attack on a convoy of 250 vehicles near Joigny. Such smashing attacks both stimulated and disorganized the German retreat. Action by an element of 363d FB Group produced remarkable results when it put seven heavy guns out of action near the Seine crossing at Le Manoir on 23 August.

Earlier, on the 12th, ground requested an attack by eight planes of 36th Group on six destroyers leaving the harbor of Lorient, one of which was left burning. Two actions against ground troops also should be mentioned here. On 9 August a formation of 363d FB Group giving armored column cover over the Brest peninsula, strafed a column of 100 horse-drawn vehicles until they waved the white flag. Even more remarkable was the action on the 14th of a squadron of 405th FB Group which was covering the 7th Armored Division in the Dreux-Nogent le Rotrou area. It had strafed trucks when it observed Germans in the road waving white flags. The squadron buzzed them several times as several hundred formed column and marched toward our lines. Ground was informed, and troops were sent out to receive that portion of the Wehrmacht which had surrendered to XIX TAC.

Other Tactical Operations in August

Armored column cover and armed reconnaissance over the battle area constituted a first claim upon the resources of XIX TAC throughout August and absorbed the bulk of its energies. However, special missions and armed reconnaissance directed against targets or areas well beyond the front lines were another feature of the command's manifold activities. Since the many columns of TUSA were advancing over so great an area and at such considerable speed during this period, many of these missions are almost indistinguishable from those in the battle area. Moreover, many stand in some sort of relationship to the modified interdiction program then current, if only because rail and road targets--i.e., communications targets in general--were either assigned to, or selected by the leaders of such missions.

Once more we must depend upon selected examples to present this activity in which XIX TAC was to some extent engaged on nearly every operational day during the month. For the sake of clarity, areas of activity will likewise be selected. First, there is the region within the Seine-Loire interdiction line where the relationship of armed reconnaissance to the battle zone is generally most intimate. Second, activities in the area east of Paris-Reims, Soissons, and eventually Verdun will be treated. Third, the area southeast of the capital--Montargis, Gler, Troyes, and as far east as Neufchatel--will furnish useful examples. Fourth, missions in the area south of the Loire will be illustrated.

Transportation Targets

Within the Interdiction Zone. In the area within the interdiction line most missions fall within the time limits of 1 to 19 August. At its outset there is a formation of 358th FB Group bombing hay wagons which concealed AAA guns near Lamballe (1 August), and another from 405th FB Group destroying seven tanks and twice that number of LT in the vicinity of St. Malo (3 August), as TUSA's columns overrun the Breton peninsula. At its close 362d FB Group is strafing barges southeast of Paris, destroying two and damaging more than 50, and the 405th FB Group is claiming 13 barges destroyed and 27 damaged in the Melun area (19 August), as American forces threaten to cross the river barriers south of the capital. In the intervening period a number of actions provide useful examples. Armed recon (14 August) by two squadrons of 373d FB Group in the Domfront area resulted in claims of three rail cuts and 22 freight cars destroyed. When squadrons of 36th Group hit the marshalling yard at Chartres (7 August) 85 to 100 freight cars were left burning. A flight from the same group scored 16 direct hits on the rail center at Lorient three days later and destroyed a flak battery and over 40 cars. In the Tours region three squadrons of 373d Group claimed on the 8th at least six rail cuts and the destruction of 38 cars, including many tank cars. The destruction of 13 tanks was reported after missions were flown by 36th Group in the Nantes-Lorient area on 10 August, and rail targets were hit by 405th Group in the Nogent-Vendome area two days later, with

claims of four locomotives and 68 cars destroyed. On 13 August 358th, 405th, and 406th TD Groups hit six trains during the day's operations. The claims of 405th Group included the destruction of 11 locomotives and over 120 cars, many of them carrying ammunition or oil; while 358th reported the destruction of 11T and hits on an ammunition dump. In view of the battles raging in the Argentan area, such actions possessed peculiar value in denying supplies and reinforcements to the hard pressed enemy and in reducing his capability to effect a withdrawal.

The Area East of Paris. Armed reconnaissance penetrated the area east of Paris throughout the month. On the 2d, 36th Group destroyed an ammunition train at Noyon, hit another at nearby Appilly, and by strafing destroyed an oil train and many barges on the Oise canal. Five barges destroyed near Soissons, together with trains strafed, were among the claims of 373d Group on 7 August. Railway targets at Crepy en Valois, at Peronne, and at Soissons were among those selected for attack by 363d Group's four missions on the 11th. Later in the month, coincident with the advance of ground forces to the east of Paris, actions on 25 August further disrupted enemy transportation in the general area of Soissons-Laon-Reims: 36th Group claimed 5 locomotives and 40 cars; 405th Group reported 19 locomotives and nearly 170 cars destroyed. In the vicinity of Soissons on the 27th, 373d Group sought out a different type of target and reported a barge, 34 11T, and 6 tanks among its claims. At Vouziers, on the Aisne northwest of Verdun,

rockets of 406th Group destroyed five gun positions on the closing day of the month.

The Area Southeast of Paris. The area southeast of Paris assumed unusual importance in the course of August--through it the enemy sought to funnel a portion of his troops in the course of his withdrawal, and into it EUSA's columns advanced on the roads to Troyes and beyond. Here, too, XIX EAC's armed reconnaissance missions were active. For example, 405th Group, operating in the Montargis area on the 10th, bombed a train of 30 cars, strafed 25 cars on a siding with fires and explosions resulting, and twice strafed a loaded troop train, inflicting heavy casualties upon its personnel. The group claimed a total of 11 locomotives and 146 cars destroyed during the day. On the following day the marshalling yard at Montargis was well hit by 406th Group and bombed by 373d Group on the 12th. In an attack by four squadrons of 362d Group on 18 August a railway bridge near Gien was rendered impassable by bomb damage; while at Joigny, further to the east, 373d Group cut tracks, fired an ammunition dump, and destroyed rolling stock on the 22d. Finally, on 28 August, a squadron of 405th Group made a particularly successful attack on the marshalling yard at Neufchateau, some 25 miles south of Toul. Here they found six locomotives and a train loaded with JU-88 fuselages. Strafing destroyed three locomotives and damaged the contents of the train.

South of the Loire. Actions in the area south of the Loire possess special interest because of XI EAC's mission to protect the exposed

southern flank of TUSA. Attacks on communications would inevitably affect the enemy's capacity to concentrate his forces. Such attacks were delivered as the following illustrations indicate. The 373d Group claimed the destruction of 15 freight cars at Villefranche and of tank cars south of Blois on the 9th. Two days later 406th Group reported the bombing of a train loaded with 60 tanks east of Montrichard, the complete destruction of a fuel train, and damage to another. On 12 August 373d Group reported bombing trains at Chambourg and Loches, while 362d Group bombed four rail centers south of Nantes. Trains south of Blois, near Issoudun, and at Mehun were struck by 373d Group on the 16th; the next day 406th Group attacked the railway center at Chateauroux, while 371st Group hit three others below Nantes. On 27 August 373d Group attacked canal and rail targets in the Bourges-Nevers area, while on the 28th two squadrons of 362d Group reported the destruction of no less than nine locomotives by bombing and four more by strafing in the region Saumur-Chateauroux.

The illustrations given above of XIX EAC's activity beyond the battle lines indicate clearly that such actions supplemented those of direct air-ground cooperation in powerful fashion. Such missions, and many others of like character, made their contribution to the total claims of XIX EAC, notably against communications targets, which are given below. The command was fulfilling one of the missions of a tactical air force by disrupting enemy communications.

Aerial Combat and Airfield Attacks

Formations of XIX EAC engaged in one or more air combats on some

17 days during August--a fact which indicates a greater activity on the part of the GAF than in the preceding month. Each day during the critical period 7 to 20 August was marked by one or more such encounters. The enemy formations varied from small flight- to elements composed of from 20 to 80 aircraft; and when the larger units were encountered, American planes were usually outnumbered. On 7 August several encounters occurred. Each of two squadrons of 373d Group met with 20- plus enemy aircraft in the vicinity of Chartres. They destroyed a total of five, while a third squadron in combat with a smaller formation, brought the group's claims to 6-1-3 for the day. An eight-plane formation of 302d Group spotted twice their number of German aircraft and shot down three. While in equal combat with 12 enemy planes over Bayonne, aircraft of 354th Group claimed 5-0-2 for a loss of two. A novel combat took place on the 11th when planes of 408th Group scattered an aggressive enemy formation by discharging their rockets. On the 13th eight aircraft of 363d Group bounced 12 GAF planes in the vicinity of Le Mans and scored 4-1-1, while another formation of the same group bounced 20 others in the same area and claimed 2-4-0. No losses were experienced in either combat. Three eight-plane sections of 373d Group joined battle with the GAF on 15 August. The first had bombed the airfield at Dreigny when they were bounced by an equal number of 104-109's whose pilots were aggressive but not well trained. Claims of 5-0-3 were reported. The second section encountered seven enemy planes near Chartres and destroyed five; and the third, jumped by 20 Germans near Comoy, lost three planes in the engagement but downed four of its adversary's. The 16th saw 354th Group score 13-0-2 in

301

aerial combat. Eight of its planes spotted a German formation of 70, destroyed two, and forced the remainder to abandon their mission. Two American planes were lost here, and no more were in a notable action over Lintonen. Here the assault area patrol of eight aircraft bounced a German formation of 30 which was soon joined by 60 others. The enemy was both aggressive and experienced, but was routed in combat ranging from 11,000 feet to the deck, with claims of 11-0-2.

Squadron formations of 400th Group met the enemy in the air over the Paris area on 19 August. A first encounter with 30 enemy planes resulted in the destruction of four. In the second, the American squadron, caught without ammunition when attacked by 12 of the GAF, hit the deck, where skillful maneuvers on the part of American pilots caused two German planes to crash. One of our planes was lost in these engagements. Claims were 6-0-1 on the 206th, when eight planes of 362d Group on a cover mission met 32 Germans and a single pilot destroyed four. On 22 August 16 aircraft of 354th Group destroyed eight enemy planes which they had bounced as they were taking off from an airfield near Epervy. A squadron of 362d Group bounced 30 Germans over Montecassiccourt with claims of 2-1-0, while elements of the 353th Group, flying cover for the ground forces west of Chartres, claimed 4-0-1 for a loss of one in an encounter with 30 ME-109's. The 354th Group claimed a total of 36-1-8 on 25 August as the result of three actions which developed in the course of fighter sweeps east of Paris. In the first, 11 of its planes bounced 30-plus of the enemy near Pethel, with claims of 10-1-3. In the second, a formation of 15 planes attacked two

~~CONFIDENTIAL~~

German formations of 12 each in the Reims area and reported 13-0-2. In the third, two German formations of 18 each were attacked by 12 American aircraft which claimed 13-0-3. The only U. S. losses were experienced in the third encounter when the report was four aircraft missing, no information on three others, and one pilot forced to bail out. Other air encounters during the month by elements of XIX TAC brought the total score for the command to 167-16-34. On the one hand such figures, and the details of such actions as have been narrated above, show an effort on the part of the GAF to stay our advance on the ground or to protect its own bases in the Chartres-Paris-Reims region. On the other hand they exhibit the quality of American pilots as well as the contributions of XIX TAC to the maintenance of Allied air superiority.

A further contribution to that same result was made by XIX TAC in destroying enemy aircraft on the ground, the total claimed for the month being 66-4-23. Major increases in this total were the consequence of attacks upon enemy airfields serving the battle area. On 7 August 12 planes of 354th Group found a well camouflaged field near Chartres, where they destroyed 13; on the same day a squadron of 3631 Group destroyed eight and damaged three on another field in the same vicinity. Two days later 354th Group strafed enemy aircraft behind retreats on a field north of Reims and claimed 0-0-2; and on the 22d it destroyed four on a grassed field at Epernay. On the 25th the same group reported claims of 10 destroyed near Ecuwais and three more in the vicinity of Reims. Nine were claimed destroyed by 405th Group near Neufenateau

~~CONFIDENTIAL~~

on 23 August. On infrequent occasions some damage was done to hangars and other installations in the course of these actions. Fields such as those at Bretigny and Chartres (15 August), at Greil (23 August), and elsewhere in the Paris area (23 August) were also attacked, although with less significant individual results.

The Breton Ports

No operational narrative of XIX TAC for the month of August would be complete without mention of its participation in the assaults upon the enemy-held ports in Brittany. Its activities at St. Malo were on a limited scale--e.g., 371st TD Group's missions against shipping in the harbor (4, 5 August) and its bombing mission against the Ile de Cezenbre (23 August). At Brest it was another story as the ground forces began to exert strong pressure upon that citadel. The account of operations there will be given in another place.

Recapitulation

In conclusion, the statistics for the month's activity on the part of XIX TAC must be given. They embrace, without distinction, all types of missions flown and therefore indicate the command's total effort and total claims. Both are impressive. The claims are of particular interest because from them, better than from any other available evidence, an estimate of the results achieved may be formed. It should be observed in this connection that the claims of most individual missions were small. The impressive totals are the result of summing up the results of the many missions flown during a month

of intense activity. It is believed, moreover, that any possible exactation of individual claims is more than offset by the fact that observation of the effects of many missions was impossible, with resulting entries of IPD (no results observed) in the records.¹⁹

Examination

Air Operations

Sorties	12,893
Losses	114
Enemy aircraft (air)	183-16-74
Enemy aircraft (ground)	68-4-38
Enemy aircraft (total).	299-20-62

Ground Targets Destroyed or Damaged (pilots' claims)

Motor vehicles	4,058
Tanks and armored vehicles	469
Horse-drawn vehicles	596
Locomotives	246
Railroad cars	2,953
Dories and river craft	155
Merchant vessels	18
Naval vessels	8

Attacks on Stationary Targets (bombing or strafing or both)

Gun positions	332
Machine-guns	59
Ammunition dumps	11
Fuel and supply dumps	13
Engine installations	3
Airfields	17
Enemy headquarters	7
Troop concentrations and bivouac areas	41
Baracks and other enemy buildings	53
Rail lines cut	132

Since much of this impressive record was compiled as the result of air-ground cooperation activities, the commendation of XIX ACG by General Patton, Commanding General, Third U. S. Army, is pertinent. His commendation in awarding General Meyland the Bronze Star is particularly pertinent:²⁰

The superior efficiency and cooperation afforded this Army by the forces under your command is the best example of the combined use of air and ground troops I have ever witnessed.

Due to the tireless efforts of your flyers, large numbers of hostile vehicles and troop concentrations ahead of our advancing columns have been harassed or obliterated. The information passed directly to the head of the columns from the air has saved time and lives.

I am voicing the opinion of all the officers and men in this Army when I express to you our admiration and appreciation for your magnificent efforts.

IX Theater Command

Modifications of the Interdiction Program

IX BC continued to devote a considerable portion of its powers to the execution of the interdiction program during the month of August 1944. That program was, however, considerably modified during the period. On 2 August it was prescribed at Army's request that no bridges, fuel dumps, or similar targets in the Brittany peninsula should be attacked except on request of Twelfth Army Group.²¹ The advancing columns of TUSA could, and did, make good use of bridges and of any fuel they might find. Furthermore, on the same day and at the request of Twelfth Army Group, it was determined that no rail communications or facilities should be bombed west of, but not excluding, the line Ste. Gaudence-Montjean au Perche-La Halle-Coulamby -Laval-Angers and thence to the sea following the line of the Loire. Trains in movement were exempted from this prohibition.²² The line was later shifted to the east. By 8 August no attacks were to be made on rail communications targets west of a line running from the sea to Fouin and thence through Ninter-Coulevert, Irzun, Haintonen, Chartres, and Clèves to the Loire at

Decommission and down the Loire to Nantes. The Loire bridges on this line were not to be bombed, but all others were on the eligibility list.²³ Later, at about 1900 on 17 August, AFHQ stipulated that no bridges of any kind were to be attacked without its express authorization. Later still, on 27 August, it was stipulated that as far as possible no attacks should be made on railway cars left without engine or blocked by rail cuts, unless it were known that they contained military supplies.²⁴ All these prescriptions exercised a limiting effect, geographically or in respect to targets, upon the execution of the interdiction program.

Certain of the above restrictions, coupled with the changing situation on the ground, caused a basic revision of the interdiction program itself which was announced on 9 August. Under the terms of the schedule then issued, the Primary Interdiction Project, enjoying first priority, was defined as including eight Seine railway bridges down-river from Paris, 13 highway bridges over the river between Paris and Rouen, and six railway bridges in the Paris-Orleans gap. The purpose of this line of interdiction was, as previously, to deny the enemy access to the battlefield.

Second priority was accorded to 21 railway bridges on the Second Bridge Interdiction Line. This line started near the coast at Etaples and went in a wide arc to the east of Paris, running through such critical points as Peronne and Metz to the northeast, Fismes and Montevill to the east, Nogent and Luxerre to the southeast, and reaching the Loire at Nevers. The purpose here was to impede the enemy's movement into the Paris area.

The same general purpose created third priority to be given to nine railway bridges which constituted the so-called Oise-Saône Interdiction Line. If established and maintained, this would reinforce such effects as were produced on the Second Bridge Interdiction Line and make access to Paris from the north doubly difficult. The bridges, all crossing the Oise, extended northwest from that river's junction with the Seine, near Comblanc, to Chauny.

Fourth priority went to 19 supplementary interdiction points, attacks on which would reinforce results achieved by those upon targets enjoying higher priorities.

Because of its importance as a plan, the full schedule is given here.²⁵

Interdiction Plan, 9 August 1944

SCHEDULE 1. Primary Interdiction Project. First Priority.

Railway Bridges

- | | | | |
|------------|--------------------|--------------------------|---------------|
| 1. Rouen | 5. Le Mesnil Ande | 9. Chery | 13. Cloyes |
| 2. Gisors | 6. Vernon | 10. Maintenon | 14. Beaugency |
| 3. Orval | 7. Montecassicourt | 11. Chartres- | |
| 4. Le Mans | 8. Montecassicourt | Oiseme | |
| | | 12. Chartres (Southeast) | |

Highway Bridges

- | | | |
|--------------------|--------------------------|--------------------|
| 1. Rouen (west) | 5. St. Pierre de Vouvray | 9. Montecassicourt |
| 2. Rouen (east) | 6. Courcelles sur Seine | 10. Langisport |
| 3. Elbeuf | 7. Vernon | 11. Meulan |
| 4. Pont de l'Arche | 8. Bernicourt | 12. Comblanc |
| | | 13. Feigny |

SCHEDULE 2. Second Bridge Interdiction Line. Second Priority.

- | | | |
|------------------------|----------------------|-----------------------|
| 1. Nogent | 8. Beator | 15. Jaligny |
| 2. Evreux | 9. Longy le Chateau | 16. Lavarre |
| 3. Beaulieu | 10. Elbeuf | 17. Glamecy |
| 4. Corbie | 11. Montcuil | 18. Neuilly sur Loire |
| 5. Peronne | 12. Les Boulons | 19. Gien |
| 6. Ham | 13. Nogent sur Seine | 20. Sully |
| 7. Montecourt-l'Esneux | | 21. Orleans |

SCHEDULE C. Oise-Saône Interdiction Line. Third Priority.

- | | | |
|---------------------------|-------------------------------|--------------|
| 1. Conflans-Oise
River | 4. Vallandouls-L'Isle
Adam | 7. Verberie |
| 2. Fontaine | 5. Decoumont | 8. Compiègne |
| 3. Avers sur Oise | 6. Grand St. Maximin | 9. Chauny |

SCHEDULE D. Supplementary Interdiction Points. Fourth Priority.

- | | | |
|----------------------|----------------------------|----------------------|
| 1. Epone-Montiers | 8. Fithiviers | 15. Aveluy |
| 2. Epemon | 9. Souppes | 16. Aniers |
| 3. Comblains | 10. Montargis | 17. Abbeville (east) |
| 4. Malun (west) | 11. Tere en Tardenois | 18. Abbeville (west) |
| 5. Montcaumon (east) | 12. Rheims | 19. Marghle le Vieux |
| 6. Gisors | 13. Soissons | |
| 7. Sarguemont N/Y | 14. Elixecourt-Condé Tolle | |

A directive of Headquarters Ninth Air Force transmitted these schedules to IX BC together with a list of all targets currently authorized for attack by it. It stated that in an over-all general priority communications, targets ranked first, fuel dumps second, and ammunition dumps third. New targets were to be passed to IX BC by Headquarters Ninth Air Force, if accepted in the daily conference between that headquarters and Advanced Headquarters AAF. From such materials IX BC was to make detailed selection of the targets and weight of attack for each day's operations. It was to select the force employed with a view to assuring adequate destruction in the initial attack and, where doubt might exist as to the exact force necessary, to err on the side of over-saturation. High priority targets attacked unsuccessfully were to be rescheduled immediately. No attacks were to be made within the cities of Reims or Chartres, on the Mirville bridge, or on shipping; and G-00 attacks were forbidden where the target's proximity to a city or village unnecessarily endangered its population or buildings.²³ In exercising its responsibilities, however, IX BC was restricted by the

series of directives from 2 to 17 August. Brittany targets were prohibited (2 August), and those within the interdiction arc were progressively reduced (2, 8, August). Although new interdiction targets were provided by the schedules of 9 August, all bridges were excluded from attack unless specific authorization were given on the 17th.

Interdiction Attacks

Seine Bridges

Under the new conditions described above, IX BC continued to follow up the interdiction program by attacking significant scheduled targets on each day in the period 1 to 16 August 1944. Bridges at two points on the Seine required further attention. A group mission against Mantes-Gassicourt probably rendered the structure unserviceable (3 August), and another cut the lines west of a temporary span (8 August). Oissel was attacked by a group of A-20's on the 6th and the approaches to the new span damaged. Possible damage to one of the bridges there was reported following the last of the attacks on Seine structures on 12 August. However, later ground investigation disclosed the fact that this railway bridge was being used for vehicular traffic at the time of the 12 August attack. Many vehicles were destroyed on the bridge, and the block thus created caused a notable traffic jam. For approximately five miles back into the country, ground observers noted a line of vehicles and guns. All vehicles had
27
been either burned by their crews or set on fire by strafing.

Paris-Orleans Gap

In the Paris-Orleans gap six targets were bombed during this period. The few planes which completed their mission on 1 August did no damage to the railway junction at Epone-Mezieres, but three subsequent missions damaged the embankment or cut tracks. Lines were cut by the group which attacked the bridge at Maintenon (1 August), and while the first two of the three group missions against Chartres (1, 3 August) failed to destroy the bridge, the third (9 August) collapsed the east span. Epernon embankment was hit four times (4, 9, 10, 14 August), the last attack being delivered at Army request; and on each occasion damage was done to the lines there. Lines were rendered unserviceable by group attacks on the bridges at Nogent le Roi (7 August) and at Cherisy (13 August).

Loire Bridges

In the short period when Loire targets were generally open to attack (1 to 8 August), four were bombed by group missions. On 1 August the embankment at Bouchemain (near Angers) was cut and the bridge at Les Ponts du Ce rendered unserviceable. The same day approaches to the Cinq Mars bridges were hit, while the eastern structure was broken in two places by a follow-up attack on the 2d. Hits on the approaches to a bridge at Nantes made it temporarily unserviceable.

Inside the interdiction Zone

August directives speedily eliminated the targets within the

Seine-Loire arc which had, in previous months, figured conspicuously in the operations of IX BC, and only a few attacks were delivered--all in the period 1 to 5 August. Both ends of the bridge at Nogent sur Loire were severed by a bombing on the 1st, and severe damage caused by one at Meroy on the 3d. Seven bridges within the arc were attacked by as many groups on 5 August, the most conspicuous results being those attained at Le Mans, where all lines were cut, and at La Croisille and Laigle, where approaches were reported severed. The other attacks, like those earlier delivered at Bourth (1 August) and La Chenaie (3 August), inflicted only incidental damage. On the 6th, however, a group attack on the Courtalain bridge destroyed its southern half and likewise a locomotive and 13 cars which were on the structure at the time of the bombing. The same day a group attack hit the approaches at Beaumont sur Sarthe. Thereafter there were no attacks on bridges in this area unless at Army request.

Bridges East of Paris

Although bridges on the new interdiction line to the east of Paris (Schedule B, second priority) did not appear on a formal listing of targets until the 9 August directive, the campaign against them began on the 7th. Then the bridge at Nogent sur Seine was bombed by 14 aircraft to block the movement of divisions from the south into the Paris area, and hits were scored on tracks. On the same day the bridge at Corbie was partially destroyed by a group attack, while another caused the lines at Neuvy sur Loire to be

classed as unserviceable. On 8 August no less than eight points on this line, ranging from Frevent in the north to Joigny in the south, were subjected to attacks of group strength. At Joigny hits were scored on the bridge and on a train crossing it. The structures at Nanteuil, Peronne, and Jussy were reported unserviceable or probably unserviceable; and damage was done to the lines at Frevent, Doullens, and Les Foulons. Only at Anizy le Chateau did the attack lack effect. This bridge again escaped injury on 10 August; but on that day the northern half of the structure at Nogent sur Seine was destroyed by a group attack, and hits were scored on the approaches at Peronne. Fismes was again a target on the 11th and the 15th: the first attack made the lines unserviceable, and results of the second, when only three planes attacked, are unknown. On 13 August, Beautor was bombed for the first, Doullens for the second, and Peronne for the third time since 8 August. These group assaults damaged Beautor, rendered Doullens unserviceable, and probably displaced the structure at Peronne. Since the lines at Les Foulons were expected to be passable by 13 August, this target was again attacked, with probable heavy damage, on the 14th. On that day a group mission against Frevent blocked through traffic in the marshalling yards there. Altogether, 12 of the 21 points on Schedule B had been attacked between 7 and 16 August, with a result of six bridges partially destroyed or rendered unserviceable.

Oise-Sambre Line

Attacks on the nine targets which appeared on Schedule C of the

9 August directive were begun on the day it was issued, when five of them were bombed. After the second of two attacks on Chauny, damage to the bridge and its embankments classed it as unserviceable. Cuts at both ends were reported at Beaumont and the center span at Compiègne was destroyed; while at Valmandois-l'Isle Adam the lines were rendered unserviceable. A sixth bridge was struck on the 11th, when with a view to impeding the movement of three enemy divisions reported moving into the Paris area from the northeast, Creil St. Maximin was severely damaged. Second attacks on Pontoise (14 August) and Valmandois-l'Isle Adam (15 August) rendered the lines unserviceable in each case. On the 15th an attack on Avers sur Oise probably broke the bridge there. This attack, and one whose bombs blanketed the marshalling yard at Compiègne the same day, were designed to block an enemy division moving from Belgium into the Paris region. Nine attacks, each in group strength, had blocked traffic over seven Oise bridges, at least temporarily, between 9 and 15 August and by so doing contributed to the effectiveness of the interdiction program.

Air Strikes on the Enemy's Line of Retreat

While not integral parts of the formal interdiction program, certain attacks by IX BC on enemy communications possess special significance because of their relationship to the tactical situation on the ground. That the enemy intended to withdraw eastward from the Argentan area was suspected as early as 12 August; by the 14th such

~~CONFIDENTIAL~~

a movement was definitely under way across the Touques and Risle rivers towards Rouen. By the 20th, German troops were packed in the wooded areas on the west bank of the Seine in the vicinity of Rouen at ferry crossings which they could use freely only at night.

As this situation developed, IX BC was called upon to act. Earlier it had devoted its energies to preventing enemy movement into the battle area. Now it acted with opposite intent--to prevent his movement from the battle area so that his armies might be there destroyed. Action followed action in the period 12 to 27 August, with this mission always in view.

On 12 August six groups were assigned the task of blocking roads west of Falaise and Argentan about such centers as Conde sur Noireau, Flers, Briouze, and La Ferte Macé, although the towns themselves were to be avoided. Some 40 points were specified for attack. Aircraft were over their targets from 1931 to 2051 hours, and 153 planes dropped 237.55 tons of 100-, 500-, and 1,000-pound GP bombs, some with delayed-action fuzes to harass night movements. In the case of 13 road points, success was achieved in varying degree; in the majority of cases either no bombing took place or no damage was ascertained. Since some concern developed lest allied advance into the bombed area be hampered by 12-hour delay fuzings such as had been employed on some of the bombs dropped, later missions of like character used a six-hour delay as a maximum.

The following day the road net in the general area of Lisieux served as the objective, and upwards of 70 points were marked for attack. These ranged from Pont l'Eveque in the north, through

~~CONFIDENTIAL~~

Bernay and Broglie, to the vicinity of Rugles in the south. A total of 281 aircraft from eight groups dropped over 430 tons of 250- and 500-pound GP bombs, with results generally more gratifying than those of the previous day. Damage was done in some 30 places where bombs fell on or across roads or where intersections were reported blanketed.

At Army request, bridges over the Touques River, which flows through Lisieux to the sea, were assigned as targets for three attacks by 18 to 19 planes each, on 14 August. Hits were scored at Notre Dame de Courson, and strikes covered two bridges near Quilly le Vicomte. At Gosset no damage was done.

On the 15th, road junctions east of the Risle River and four bridges over the river itself were ordered attacked by four groups. A total of 125 aircraft was dispatched, but all were recalled because of unfavorable weather. The Risle bridges were, however, rated as of such importance in the effort to block the enemy's escape routes that attacks were made on them in the course of the two following days, with a PFF plane leading each of the attacking formations. The first attempt on 16 August to bomb the bridges could not be carried through, but the second resulted in the bombing of five on PFF. At Thibouville results were unknown. Possible damage was reported to structures at Fort Audemer and Brionne. On the 17th four of the bridges attacked the previous day were rescheduled for attack, together with six others. Weather was not favorable: two of the 11 groups participating did not bomb, while others bombed on PFF. Of 375 planes dispatched, 289 attacked, dropping

466.75 tons of bombs. The bridge at Beaumontel was blanketed and that at Launay possibly damaged, while the approaches at La Ferriere, Beaumont le Roger, Nassandres, Pont Authou, and Pont Audemer were hit. A second assault on the 17th against five other bridge targets in the same area again employed PFF. Four groups participated, one dividing its strength between two objectives, the others concentrating on one. A total of 238 tons of bombs were dropped by the 123 aircraft attacking. The bridge at Le Bourg was reported blanketed and the approaches damaged at Appeville, Foulbec, and at one of the structures at La Rabellerie. Later investigation on the ground indicated that road craters had temporarily blocked traffic in the attacks of 16 and 17 August at Brionne and Thibouville. In the first instance the town was badly damaged and heavy casualties inflicted on civilians. In the second, a large area of the town was destroyed.

A few days later IX BC joined fighter-bombers in the effort to harass the enemy, who was then seeking to cross the Seine. On 20 August attacks on three forest areas just west of the Seine were planned, but only one could be carried out. Two groups, however, dropped over 120 tons of 260-pound frags on German concentrations in the Forêt de la Lande. Nearly a week later like targets were hard hit in the same area. On the 26th seven groups attacked, followed by seven more the following day. On the 26th, 179 aircraft dropped 232.5 tons of 500-pound GP bombs and 260-pound frags; on the 27th, 141 planes bombed with the same weight of 500-pound GP bombs

together with 260-pound and 500-pound frags. In each attack the majority of the bombs were reported to have fallen in the target areas. No other evidence of the results of these attacks is available, although it is assumed that enemy losses were severe.

Enemy Supplies

Throughout the better part of August fuel and ammunition dumps figured as second and third priority targets for IX BC. Such targets, located in some 30 places, were in this period the objectives for 34 attacks delivered by 12 to 132 aircraft. The purpose of the attacks was to destroy stocks upon which German troops in the battle zone depended, and thus further to attenuate their supplies of vital materials.

In the early days of the month, when the Argentan pocket was taking shape but before the mass withdrawal began on the 14th, 13 dumps in or near the battle area were bombed. The familiar target of the Foret d' Andaine was subjected to attack by four groups which dropped over 164 tons of bombs (6 August). Dumps in the Foret de Sille (5 August), the Foret de Perseigne (6 August), and Le Lude (2, 7 August) were also struck. All of these were in the immediate area of conflict, but hits were also made on targets some little distance from the troops which they served. Among them were dumps in the Rouen area at Caudebec (2, 10 August) and the Foret de Roumare (11 August) and another at Le Buisson near Evreux. To the west of Paris, fuel stocks at Maintenon were struck (3 August), and to the south of the capital those at Corbeil were bombed (13 August). Along

the Loire, dumps were selected for attack in the Foret de Blois (6, 7 August), in the Foret de Montrichard, east of Tours (11 August), and at Bauchos du Desert in the Nantes area (7 August).

From 15 August the dumps attacked were somewhat farther removed from the battle area, although their relationship therewith was so close as to warrant army requests for bombings. Targets close in to Paris were bombed at the Foret de Chantilly (15 August), the Foret de l'Isle Adam (18 August), and Valentin (18 August). Others were hit in the Compiegne-Chauny-Laoz region, Compiegne, itself, and Compiegne-Clairox (26 August), the Foret de l'Aigue (28 August), St. Cobain (26 August), Parisis (28 August), and the Foret de Samoussy (27 August). In the Beauvais area attacks were made at Harseilles en Beauvaisis (15 August) and at Fournival (26 August). Other attacks were made yet farther north in the Somme region at such points as Ham (28 August), Doullens (28 August), and farther to the west in the vicinity of Arques (29, 31 August), and at Querrieu (28 August).

In only a few cases is there direct evidence of results achieved. Reports of many craters observed following the two attacks on the ammunition dumps at Le Lude (2, 7 August), of explosions and fires produced at Compiegne (26 August), and of like results at Doullens (28 August) and the Foret d' Arques (31 August) are exceptional. Even more exceptional is the statement that at Corbeil (13 August) the point at which fuel was transferred from tank cars to barges was completely obliterated by a group attack. In the other cases reports state merely that bombs fell in the target areas

or declare that the results of bombing were non-assessable, as in the extreme cases of night bombing of dumps at the Forêt de Sille (5 August) and the Forêt d' Halouze (13 August). In the course of the month over 1,600 aircraft participated in these attacks, dropping some 2,288 tons of bombs.

The Breton Ports

IX BC participated in the efforts to reduce the enemy strongholds at St. Malo, on the near-by Ile de Cezembre, and at the fortress of Brest during August 1944. In all cases the actions, planned in conjunction with the assaulting forces, are to be classified as air-ground cooperation and related to the efforts of Ninth Air Force fighter-bombers against the same objectives.

St. Malo

In the case of St. Malo, IX BC attacks upon the citadel at St. Servan began on 8 August with an attack by two groups carrying 1,000-pound GP bombs. On the 11th a single group dropped 500-pound GP's, and on the 15th three groups bombed with 250-pound GP's, 100-pound incendiaries, and 1,000-pound SAP's. A total of 208 aircraft attacked on these three occasions, dropping 319.5 tons. The target was an underground fortress, well provided with deep shelters, whose pill boxes, gun emplacements, and strong-points were all protected by heavy reinforced concrete. No penetration of these structures was found when the citadel was examined by ground observers, nor was evidence discovered of damage done by incendiaries.

Prisoners' statements indicated that the bombings were hardly felt in the shelters, and that attacks from the air did not influence their
29
surrender on 17 August.

Ile de Cezembre

The Ile de Cezembre, which controlled the deep-water channel to St. Malo and the approaches to Granville, was likewise attacked several times by Ninth Air Force mediums as well as by its fighter-bombers. One group delivered a night attack with the aid of flares shortly after midnight 6-7 August, and reported that 250-pound and 500-pound GP's scored near misses on the batteries which were holding up the ground attack on St. Malo. Heavier attacks followed. Two groups, equipped with pathfinders and armed with 500- and 2,000-pound GP's and 1,000-pound SAP's, bombed the island again on the 11th. On the 30th two groups led by pathfinders dropped 500-pound and 1,000-pound GP's in the target area, while the next day, when fighter-bombers attacked with Napalm, mediums of three groups, again led by pathfinders, mixed in a few 500-pound GP's with their main loads of 1,000-pound SAP's. Ground and naval artillery had shared in the bombardment of the target--an island one-half mile long and one-quarter mile wide. When ground observers had an opportunity to examine the island, they were struck by the fact that the entire island was covered with craters and debris produced by the aerial attack. Open gun emplacements and an AAA position had been demolished. Barracks and the distillation plant had been destroyed. However, while Napalm had burned out one shelter it had apparently produced little effect on personnel.

Underground shelters, magazines, control points, and the well protected OP were intact and casualties were apparently few. The surrender on 2 September was in part induced by a water shortage to which the destruction of the distilling plant had contributed. A total of 255 aircraft of IX BC had attacked the island and dropped a total of 465.5 tons of bombs. On 3 September the Commanding General, 83d Infantry Division expressed his appreciation of IX BC and IX TAC's air attacks of 31 August which had demolished buildings that could have been used as firing positions in defense of the beaches, sheared off weapons in the open, and by removing earth from camouflaged shelters and pillboxes, allowed heavy artillery to reduce the latter with direct laying. "Undoubtedly the will of the defending troops to resist was greatly lowered by the combination of heavy bombardment, the jellied gasoline bombs, and the heavy artillery, to the point where surrender was necessary."³⁰

Initial Attacks at Brest

As American forces closed in about Brest, two efforts were made by IX BC to destroy in the harbor ships which it was reported the enemy planned to use to block its approaches. On the 7th one group attacked; on the 9th, two. No damage was done by the first, while possible damage to one ship was claimed after the second attack. Later attacks on Brest are narrated below.

Recapitulation

In the course of the month of August IX BC had dispatched 9,142

aircraft of which 6,554 attacked. Thirty-four aircraft were lost and 1,032 damaged. Total tonnage of bombs dropped was 10,470.69. Claims were 2-0-2, and total casualties 304 in combat missions.

The Ninth Air Force in the Brest Campaign,
25 August-19 September 1944

The air-ground assault on "Fortress Brest," postponed because of weather unfavorable to air operations, was finally launched on 25 August 1944. It was resolutely continued until 19 September, by which date Brest itself, and likewise the Crozon peninsula, had been entirely reduced. Because it constitutes a distinct entity, it is treated in full here regardless of the time limits elsewhere observed in this section.

The Roles of IX Bomber Command, XIX Tactical Air Command

Direct air-ground cooperation was afforded to the ground assault on all save three of the 26 days involved. Fighter-bombers were active on each of the 23 operational days of the period, while the weight of medium bombardment was applied to Brest's perimeter defenses on six days during the assault period. Heavy bombardment of other air forces was also employed, but the main responsibility for tactical air operations fell to the Ninth Air Force. Until 9 September, when it was declared that Brest no longer constituted top priority for the Ninth Air Force, SHAEF determined that air strikes in that area should be accorded a very high, and at times the highest priority because of the value then attached to the port as a potential supply base. There-
fore, when IX Bomber Command operated, it operated in strength from its

bases in Essex and those in the Cherbourg peninsula, and fighter-bombers rendered vigorous air-ground cooperation under the direction of XIX TAC throughout the period. The position of this command was unusual, since at one and the same time it must cover the operations of TUSA in the east and those against Brest in the west, and hence direct operations at points over 300 miles removed from one another. Its own resources were not always sufficient to meet the demands of both; hence in the period of intense effort at Brest from 5 to 10 September, two or more groups of IX TAC were placed under the operational control of XIX TAC on each of those six days. On 5 September alone XIX TAC employed its own seven groups plus five from IX TAC.

Coordination of medium bombardment with ground effort occasioned some difficulties. Information as to the structure of the targets to be bombed was at times so meager as to prevent the selection of the most appropriate bomb loads and fuzings. On occasion targets could be designated only by means of coordinates, a fact which made their identification difficult at the time of the attack and therefore led to spotty results. Fighter-bombers were rather more fortunate. Their normal function was to furnish air-ground cooperation to the assaulting units, the ideal situation being that in which they gave continuous cover during the operational period. The techniques of air-ground cooperation were essentially those which have been earlier described; and contacts with the Air Support Parties of VIII Corps were generally successful, the targets assigned by them being attacked from the air. However, since the enemy fired white smoke shells on our positions in an effort to cause them to be attacked by friendly aircraft, colored

smoke came into use to mark enemy targets. In default of targets given them by the ground, fighter-bombers might attack predetermined targets, and in some instances they were given their targets at the time of take-off. Weather over bases, or over the Brest targets, frequently conspired to reduce the intended weight of Ninth Air Force attacks or the continuity of cover and on occasion forced hurried briefings when a mission had to take advantage of a momentary break.

The Initial Air Strikes, 25 August

On 25 August, the first day of the assault, air strikes by the fighter-bombers were chiefly directed against shipping. These unusual targets were attacked successfully. The 362d FB Group flew four missions and caused the explosion of a cruiser which was observed burning the next day. Two vessels were destroyed by rockets in the course of 406th FB Group's nine missions. In four missions by 358th FB Group two vessels were claimed destroyed and a third was left burning. The same day, one group of IX BC was assigned to each of nine targets in the Brest defenses--four coastal batteries, three AAA positions, and two strong points. In only three cases were positive effects reported: two gun positions severely damaged at Kerviniou coastal battery, one direct hit and a concentration on the AAA battery at Pointe d'Espagnols, and tracks and a road cut near the strong point in the arsenal. A total of 278 aircraft of IX BC had attacked, dropping 389.7 tons of bombs (100-, 500-, and 1,000-pound GP's together with 260-pound frags).

Air-Ground Cooperation during the Assault

As the air-ground attack progressed, IX BC continued to attack the same types of targets, the only notable variation being the bombing of bridges over the Penfeld River (1 September), while fighter-bombers attacked ground targets almost exclusively. Troop concentrations, barracks, flak positions, and above all, gun positions figure in the list of their designated targets with an almost monotonous regularity. Pilots' reports are of necessity less informative than one would desire. They specify the point attacked, on occasion declare that a battery was silenced, but more often are content to declare results poor, fair, good, or excellent, or to state that their bombs hit the target area. The nature of the attacks, the character of the targets, and the atmospheric conditions rendered more exact reports impossible. Because of adverse weather, coupled with the absence of flak, bomber attacks were often delivered from altitudes of 8,000 feet or less.

The two days 5 and 6 September saw an unusual effort on the part of medium bombers and fighter-bombers alike. The latter flew an average of over 40 missions each day with an average of over 500 aircraft dispatched on missions which attacked. The former attacked with 310 bombers on the 5th and 545 on the 6th, the planes dropping 517 and 984.65 tons of bombs, respectively. Fighter-bombers were to reach to greater heights than previously on 8 September, when 49 missions were flown with 574 aircraft dispatched to share in the operations against Brest.

Scale of Ninth Air Force Effort

The total Ninth Air Force effort in air-ground cooperation is set forth in the following table. In it are listed only those attacks which were carried through by some of the planes dispatched. 34

Air Operations Against Brest
25 August to 19 September 1944

	<u>Fighter-bombers</u>		<u>Medium Bombers</u>	
	<u>Missions</u>	<u>A/C Dispatched</u>	<u>A/C Dispatched</u>	<u>A/C Attacking</u>
Aug. 25	17	157	320	278
Aug. 26	9	143		
Aug. 27	7	144		
Aug. 28	3	45		
Aug. 31	6	90		
Sep. 1	11	103	187	115
Sep. 2	2	24		
Sep. 3	20	313	252	181
Sep. 4	1	12		
Sep. 5	42	544	364	310
Sep. 6	39	463	706	645
Sep. 7	13	205		
Sep. 8	49	574		
Sep. 9	24	189		
Sep. 10	11	172		
Sep. 11	21	168		
Sep. 12	12	99		
Sep. 13	2	16		
Sep. 14	6	48	230	144
Sep. 16	12	69		
Sep. 17	9	56		
Sep. 18	5	32		
Sep. 19	5	27		
Totals	331	3,698	2,059	1,573

Results Achieved

Most unfortunately, there is a decided lack of exact evidence as to the results produced by these attacks which involved such considerable use of Ninth Air Force resources over so long a period.

Ground investigations plus a few statements on the part of the ground forces do, however, permit some general observations and afford examples which are helpful. That our exact knowledge should be so limited is due to two factors: first, the fact that intense artillery fire in addition to various types of air bombardment so churned up the area within the perimeter defenses as to prevent the evaluation of most Ninth Air Force attacks; and second, the absence, at present writing, of any considerable mass of evidence derived from the ground forces participating.

Fortified Positions

The results of the bombing of modern reinforced concrete emplacements were negative. These structures proved practically impervious to air attack, and there appears to be no authenticated report of one being so destroyed. A 1,000-pound bomb falling close to a battleship-type turret of five-inch steel failed to inflict damage upon it. In the case of masonry forts there is one example which shows that medium bombardment could be effective. Ft. Keranaux was an old stone structure provided with a moat. Three attacks (1, 3, and 6 September) completely reduced the old fortifications and partially filled the surrounding moat, although modern emplacements suffered little. That the bombings should have been so effective is possibly due to the fact that the target was easily identifiable from the air. Attacks by mediums upon open emplacements seem to have produced good results, the number of bombs dropped in such actions increasing the chances of scoring the needed direct hits.

Fighter-bombers merely by their presence in an area served to

silence the fire of enemy artillery which they threatened. However, dive bombing of modern emplacements not previously fractured by sustained artillery fire was not effective. Direct hits on open emplacements were destructive, and blast and fragmentation effects were produced by near misses.

Evidence Supplied by Ground Commanders

From 29th Infantry Division sources come isolated examples of results produced by air strikes. Five days' softening of the strong point at Kergonant was followed by a dive-bombing attack immediately preceding the ground attack on 7 September. In the final air strike by formations of P-47's, damage was done to materiel and personnel which, coupled with the fact that air action kept the Germans under cover, allowed the capture of a first critical position. It was much the same story at the strongly defended position on Hill 89. The air strike here registered only one direct hit, the balance being near misses; but again the enemy was kept under cover as the 116th Infantry Regiment advanced and seized the position. What was in some ways the most interesting example of direct air-ground cooperation was afforded by the action against Fort Toubroch on 3 September. The commander of the 5th Ranger Battalion asked fighter-bombers on air alert for a bombing of his objective. They complied, and as their last bomb struck, the Rangers closed on the fort and took it before its defenders had an opportunity to organize for further resistance. It was reported that leading elements of the Rangers reached the position six minutes after the last bomb fell. Here the value of the close coordination of ground assault with air strike was fully demonstrated.

Evidence furnished by the 29th Infantry Division is supplemented by that of the 2d Infantry Division. On 27 August an air strike by 12 P-47's, coordinated with heavy artillery fire, knocked out Battery Demaine (coordinates 005047), producing marked effect on its bunkers and emplacements, some of which were only 200 yards from our front lines. A strafing (3 September) by eight Thunderbolts on enemy positions 150 to 200 yards in front of the 23d Infantry Regiment opened the way for their capture. Even when an element of 38th Infantry Regiment was strafed at the beginning of a run, the men who took the enemy strong point remarked that they were glad to have had the direct cooperation which had reduced an emplacement. An all-afternoon attack, in which targets on Hill 90 were pounded by artillery and bombed and strafed from the air, allowed the hill to be occupied without resistance the following morning; while Hill 100, which constituted the dominating terrain feature at the eastern edge of Brest, was completely neutralized by dive bombing and heavy artillery. In consequence it fell without excessive loss to the infantry. The infantry break-through at Ilice on 11 September followed immediately after fighter-bombers had bombed in the vicinity of the enemy's center of resistance.

General Conclusions

Such facts as the above do not give the full measure of the results produced by the several hundred missions flown by the Ninth Air Force in the assault upon Brest. They do, however, prove that on

some occasions air made notable contribution to the success achieved, even when only small air formations were employed. They further suggest that the almost constant presence of our aircraft over the assault area not merely produced an adverse effect upon the enemy's morale but also lessened his capacity to resist by reducing the volume of his artillery fire. In this connection it should be observed that our air supremacy over Brest was complete throughout the assault period. There were no encounters with enemy planes, only two aircraft of IX BC were lost in the course of its attacks, and fighter-bomber losses were remarkably low. The rate of loss from flak was undoubtedly reduced by artillery fire on flak positions prior to major air strikes. In addition it is evident that effective air attacks could be delivered against enemy positions close to those occupied by friendly troops--the entire absence of ground casualties from attacks by friendly planes constitutes further proof of the possibility of such actions. Furthermore, the value of air alert as an instrument of air-ground cooperation was fully demonstrated. Its use averted the hazards incident to planned missions, which must of necessity be laid on well in advance of the attack and without knowledge of rapid changes in the details of the ground situation produced in the interval between the briefing and the actual air strike. The device likewise allowed the ground commander to concentrate air power on active targets close to his own lines and to effect such concentration within the shortest possible time limit. Ground agreed with air on these points.

Two other matters connected with air's participation in the reduction of Brest require mention. First, air was able, as a commander

of the 29th Infantry Division testified, to make effective attacks upon targets beyond the range of ground observation. Second, throughout the assault tactical reconnaissance planes of the Ninth Air Force assisted in directing the fire of artillery. G-3 Air of Twelfth Army Group stated on 7 September that artillery officers felt that the spotting by aircraft engaged in "Arty R" throughout the Brest campaign had been the best that they had experienced.³⁷

Attacks by the Ninth Air Force continued until 19 September. On that day early missions were flown, but others were recalled, control informing them that "the war was over on the Crozon peninsula."

~~CONFIDENTIAL~~

Chapter VI
OPERATIONS IN SEPTEMBER 1944

The Ground Situation

Ground force operations for September 1944 fall into two well-marked phases embracing equal portions of the month. The first, a continuation of the Battle of France, was marked by further German withdrawals and persisted until 14 September. By that date American forces had reached Maastricht, faced the Siegfried Line from Aachen to the Moselle, reached that river at Thionville and in the Metz area, and crossed it south of Pont a Mousson and Nancy. Initial penetration of the Siegfried Line south of Aachen on 15 September began the Battle of Germany and marked the advent of the second phase of the month's operations, a phase in which operations stood in marked contrast to those of the preceding period. Problems of supply, weather, and terrain limited American capabilities, while the enemy reorganized his forces and generally stood his ground, giving way only at points in the Aachen area, in the vicinity of Metz, and south of Nancy.

Ninth Air Force Movements

Headquarters

The further advance of the ground forces in September determined that movement should continue to be a feature of the

life of Ninth Air Force units. Its main headquarters gave up its English station at Sunninghill Park and established itself at Chantilly, to the north of Paris (15 September). Advanced headquarters, streamlined to provide only essential operational personnel, accompanied Twelfth Army Group to Versailles (6 September) and Verdun¹ (20 September). In keeping with the movement of the armies with which they were associated, the headquarters of IX and XIX TAC moved eastward. Versailles (2 September) and Jamioulx, near Charleroi in Belgium (11 September), served as headquarters for IX TAC, while XIX TAC's headquarters first moved to Chalons sur Marne (13 September) and later to Etain, near Verdun (22 September). The first continental² headquarters of IX BC was opened at Chartres on 18 September.

Combat Units

These movements of headquarters were paralleled by the displacement forward of combat units. By the end of September the fighter-bomber groups of IX TAC were based on fields in the region of St. Quentin and Cambrai and on others in the Reims area, with a single group at Florennes in Belgium. The group last mentioned had occupied a Normandy base at the outset of the month. Its third move placed it on the most easterly field assigned to IX TAC at the month's close, by which time three other groups of the command had begun their movement to Belgian fields. The requirements of air operations in the Brest area caused XIX TAC to maintain some of its groups in the western area until after the reduction of the fortress on 18 and 19 September, but by the end of the month they were all

based on fields in proximity to Reims or farther to the south in the Vitry le Francois area. By 2 October the last of IX BC's groups had left Britain and become operational on the continent. The 97th Wing was by that date based on airfields just south of Paris and 99th Wing well to the north of the capital, on airfields scattered from Cormeilles through Beaumont sur Oise and Beauvais to Roye Amy; while 98th Wing had shifted from its first continental bases to a second series in the vicinity of Dreux, Chartres, Chateaudun, and Orleans.

Despite such forward movements, the fighting front outran the advance to new operational sites until mid-September, and the fighter-bombers in particular operated under disadvantages. For them the increase of the distance from their bases to the front lines was critical since an increase of that distance from 50 miles to over 100 miles served to increase the average duration of fighter sorties from two hours to almost three hours, and to boost their operational gas consumption by 50 per cent.³ A change from one field to another 200 miles nearer to the front did not obviate the necessity of using auxiliary fuel tanks, nor did so great an advantage as might be imagined accrue when a field which had been bombed early in the month⁴ was occupied before its close. On occasion the necessity of providing sufficient fuel caused a limitation of fighter-bomber tactics by preventing the use of external loadings. In early September the combination of tactical necessity and the location of their bases forced fighter-bombers of XIX TAC to make an initial flight to such forward bases as Chateaudun, Coulommiers, Juvinocourt, Reims-Champagne,

and St. Dizier, where they refuelled before flying their missions. Even then the omnipresent problems of providing adequate fuel supplies and services occasioned further problems. On one occasion fighter-bombers abandoned a mission because of lack of fuel at the advanced base; while on another, delays in refueling caused the same result. Such difficulties were only in part offset by using advanced bases for roulement planes refueling at these bases on flight to a first mission, returning for fuel and ammunition, and flying a second mission therefrom.⁵ The demands upon transportation caused by movements at a time when transport facilities were limited, coupled with difficulties of maintaining effective communications between combat groups and IX AFSC, caused the ordnance supplies of fighter units to become perilously low on occasion. The absence of trucks interfered with the effort to prestock airfields before they became operational, and with their resupply after they were in use. The absence of communications caused requisitions to move slowly with resulting delays in filling them. In spite of these handicaps no operations were canceled due to the absence of ordnance supplies.⁶ Only when the front was in some measure stabilized in mid-September and when further eastward movements of bases were effected in a later period could these problems be reduced in size and their effect upon operations be limited.

Organizational Changes

Certain organizational changes in the Ninth Air Force require mention here. Relieved of its assignment to the Ninth as of

7

26 August, IX TCC disappears from the operational narrative. On 16 September IX BC was redesignated as the 9th Bombardment Division, by which name it will be described throughout this chapter. Toward the close of the month a somewhat confused but brief relationship was established between the Ninth Air Force and XII TAC. This command was part of the Twelfth Air Force, and had accompanied the Seventh U. S. Army in its drive from southern France into Alsace. As directed by higher authority, the Ninth Air Force assumed operational control of XII TAC units on or about 24 September, and soon afterwards was delegated the administrative responsibility which USSTAF had assumed. Later, the establishment of the First Tactical Air Force (Provisional), designed to function with Sixth Army Group, of which the Seventh U. S. Army was a part, led to the attachment of XII TAC units to it. However, some measure of operational and administrative control over XII TAC on the part of Ninth Air Force continued under verbal agreements until approximately 16 November. Meanwhile a step was taken to provide XII TAC with added strength for the better performance of its mission. On 29 September, the 50th and 371st FB Groups, formerly with IX and XIX Tactical Air Commands respectively, together with ancillary units, were assigned to XII TAC. However, since the complicated relationship of XII TAC to the Ninth Air Force was so brief, and because the story of its activities, like its operational records, belongs to the First Tactical Air Force (Provisional), no attempt will be made here to set forth the operational narrative of XII TAC.

IX Tactical Air Command

Air-Ground Cooperation

The provision of air strikes in cooperation with ground units of

FUSA was continued by IX TAC. However, examination of operational records indicates that many covering missions developed into armed reconnaissance missions beyond the enemy's lines. The increased use of "Y" service for the control of airborne planes partly accounts for this change, but the main cause is to be found in the changed nature of action on the ground. The shift from pursuit to position warfare inevitably influenced air tactics. It is also true that the same records give even less graphic information of air-ground cooperation than the earlier reports record. Nevertheless, when examples are found they indicate that joint action had lost none of its efficiency. In the days when the pursuit was continuing in the north, three armored vehicles moving to attack our troops near Arlon were designated as targets and destroyed. Likewise the advance of the 3d Armored Division near Limburg was furthered when elements of 368th FB Group successfully attacked a barn where a gun was hidden (10 September), achieved what ground termed "perfect results" in bombing vehicles (10 September), and destroyed an antitank gun (11 September). Later (16 September) the same division asked planes of 404th FB Group for a strike against a German counterattack near Tirlemont, and ground reported that 10 armored vehicles were destroyed. The 368th FB Group destroyed three gun positions at the behest of 2d Armored Division (11 September), while planes of 363d and 368th FB Groups responded to that division's request for the bombing of tank traps and dragons' teeth as it sought to advance south of Aachen (12 September). By air action gun emplacements were destroyed east of Maastricht (16 September) by a formation of 50th FB Group, while

another of the same group bombed woods in the same area at request and also positions near Valkenburg (17 September), with results described as good by ground control.

Pillboxes in woods north of Aachen were the target for 24 bombs dropped by 474th FB Group in what ground termed "a beautiful job," while Leidenborn and gun positions were hit by planes from the 50th Group (22 September). "Excellent bombing" by 368th FB Group was reported following an attack requested on Geilenkirchen, north of Aachen (26 September). Other examples of joint action are found in accounts of air strikes associated with the stiff fighting in the general area of Stolberg and the Rotgen and Gemund forests. There 368th Group obtained very good results on a smoke-marked target in Rotgen forest (23 September) and excellent results on indicated strong points in the same area (29 September). An interesting feature of the latter attack was the ground request that the aircraft orbit over the area after their bombing to draw the enemy's attention away from the advance of friendly troops. The same group attacked artillery in Gemund forest and scored well in a requested strike on a smoke-marked troop concentration west of Stolberg (29 September). The 367th was credited with a "beautiful job" in dropping four tons of bombs on smoke-marked targets in the Hurtgen forest (28 September). Stepping over into the TUSA area a formation of 48th FB Group had patrolled an area west of Metz where engineers were building a bridge, and at ground's request broke a near-by dam. Out of such incidents was the story of air-ground cooperation by IX TAC composed. In the first 15 days of September alone, 183 missions had been dispatched to enable

~~SECRET~~

the command to discharge one of its major functions. The missions were usually of squadron strength with a portion of the participating aircraft assigned to the provision of top cover.

Highway Targets

Armed reconnaissance was likewise a marked feature of IX TAC's activities. The considerable effort directed at interdiction and railway targets will be treated later in connection with the interdiction program. The other missions of this type were largely concentrated in IX TAC's area of responsibility on the FUSA front, although on occasion a mission might be flown in the Dijon area (6 September) or south of the Loire in the region of Bourges-Chateauroux-St. Amand (8 September). As previously, road targets were among those attacked, particularly in the early days of the month when roads in the north were crowded with German vehicles moving to the east along the line Peronne-Cambrai-Valenciennes-Charleroi. In the first four days of September, IX TAC amassed the unusual total of 2,201 MT, 128 armored vehicles, 485 horse-drawn vehicles, and 25 horse-drawn artillery destroyed or damaged in this general area. On the single day of 3 September active hunting in the so-called Mons pocket yielded the largest claims for any day to date--919 MT, 58 armored vehicles, and 757 horse-drawn vehicles. Again on 9 September 368th Group, operating with the 3d Armored Division in the Aachen area, submitted claims of over 100 MT and 20 tanks destroyed or damaged. Thereafter the claims on individual days were smaller, but totals for the month amounted to 3,017 MT, 293 armored vehicles, and 1,468 horse-drawn vehicles. The claims inevitably fell off as the battle lines were stabilized. Barge

~~SECRET~~

traffic on the Rhine was occasionally attacked, as on 14 September when a formation of 367th FB Group destroyed four paddle boats and three self-propelled barges south of Koblenz. The month's claims of boats and barges destroyed or damaged were 31.

Special Missions

Special types of missions were occasionally flown by IX TAC. When the airborne "Operation Market" was initiated with critical bridges in the Netherlands as its objectives (17 September), 48th, 366th, 367th, and 474th FB Groups flew group-strength missions in its support. These concentrated their attacks on gun positions in order to reduce the volume of flak in the area which the troop carriers must penetrate, and they reported some guns destroyed and others silenced. Weather caused the abandonment of the efforts to continue this support on the days which immediately followed.

Night Intruders

Since the enemy was moving as little as possible in daylight because of the unrelenting efforts of fighter-bombers, night intruder missions by P-39's were attempted with a view to attacking and disorganizing his movements by night. SCR-584 was employed to bring the planes to their target and to direct their return to base. This control functioned well, but weather severely limited the number of missions which could be flown, and the malfunctioning of flares and bombs on occasion reduced the effect of such as were flown. From four to nine aircraft participated in five night intruder missions by 474th FB Group (10, 12, 17, 29 September); one plane was lost to friendly and

one to enemy flak. A marshalling yard was bombed at Mayen and the destruction of two locomotives claimed. Elsewhere trains and convoys were bombed and strafed with results usually unobserved.

Propaganda Leaflets

Leaflet bombs were likewise dropped on occasion either by missions flown for that specific purpose (e. g., 48th Group, 6 September, in the Maastricht-Tongres area), or as a feature of armed reconnaissance (e. g., 405th Group, 26 September, in the Euskirchen-Geilenkirchen area.)

Actions against the GAF

Airfields

By attacks on enemy airfields and in air encounters IX TAC assisted in maintaining air superiority and further reduced the strength of the Luftwaffe. An attack by planes of 48th Group, on a field near Giessen (9 September) resulted in pilots' claims of 3-2-5. On 10 September a field in the Frankfurt area was hit by 370th FB Group and another on the following day by the 367th, pilots' claims being 2-0-0 and 19-0-0, respectively. At an airfield near Bonn, explosions and black smoke were produced by an attack of 50th Group (12 September), while an element of the same group damaged the hangars at Hanau and claimed 11-0-2 enemy aircraft on the ground at Seligenstadt (13 September). The latter two fields were in the general area of Frankfurt. In the Koln region hangars and buildings were hit by 48th Group attacks on Ostheim and Wahn (13 September).

Air Encounters

11 September was an unusual day inasmuch as more than 70 enemy

aircraft were sighted, with two encounters taking place. When four enemy planes had the temerity to bounce 12 of a 365th Group formation in the Bonn-Duren area, all were destroyed at no loss, while a squadron of 368th Group destroyed five attacking ME-109's for the loss of one in combat over Eupen. The next day more than 70 enemy aircraft attacked 20 P-33's of 474th FB Group near Duren. Five of our planes were lost as against pilots' claims of 8-1-9. Three encounters occurred over Aachen on the 16th, together with a sighting which did not develop into combat since the enemy turned toward Koln and its strong flak defenses. A formation of 33 P-38's of 370th Group, when jumped by more than 50 enemy planes, lost one but claimed 2-0-3. Seven P-47's of 404th Group joined in the combat, engaging nine enemy aircraft and claiming 4-0-2 for no loss. In the third action of the day a squadron of 50th Group was bounced by 12 FW-190's and claimed 6-0-2 for no loss. It is significant that the day was one of continued ground effort to penetrate the Siegfried Line in the Aachen region and that the enemy was aggressive. Two days later (18 September) one squadron of 365th Group lost four planes when bounced by 36 to 40 enemy aircraft over Aachen, but claimed an equal number destroyed. Another squadron of the same group sighted 36-plus of the enemy leaving the Aachen area, but failed to pursue them. Three air actions transpired in a single hour on the 21st in the Bonn-Koln region, three group formations of IX TAC sharing the honors without loss. The 50th Group destroyed three of the 10 FW-190's which they attacked; 48th Group claimed three out of some six ME-109's which attacked them; and 367th Group reported

4-4-2 when they were jumped by 30-plus ME-109's. Further encounters occurred on each of the three days 26 to 28 September. Over Bonn (26 September) a squadron of 365th FB Group claimed 2-1-1 in a combat in which some of the enemy planes appeared to be old ME-109's. In encounter with over 50 enemy planes over Dusseldorf (27 September) 16 P-47's of 365th Group lost one but claimed 5-0-1. Finally, when 36 aircraft of 404th Group attacked 20 of the enemy over Arnhem (28 September), they suffered no loss in scoring 7-0-2. Of the enemy ¹¹ planes destroyed, a single pilot claimed six.

Total claims reported by IX TAC for September in respect to enemy aircraft were 70-11-33 in the air and 24-3-7 on the ground. In the course of the month the command had flown 307 missions, dispatching ¹² 9,708 aircraft and dropping 1,993 tons of bombs.

XIX Tactical Air Command

Air-Ground Cooperation

The Metz Area

Examples, rather than a complete narrative, must suffice to indicate the nature of air-ground cooperation between XIX TAC and TUSA on the eastern battlefields. As XX Corps developed its attack south of Metz on 10 September, a series of squadron-strength missions by 36th, 362d, and 371st FB Groups took action so effective as to earn the commendation of the ground forces. Red smoke marked a fort as target which was struck with results reported good. At Arry, east of the Moselle, one formation struck at tanks and trucks, destroying one of the former and two of the latter at request; while another made 40 individual passes at 15 tanks in the town and left them smoking and

~~CONFIDENTIAL~~

immobile. As requested by 5th Infantry Division an enemy-held area near Amanvillers was neutralized by strafing, and an ammunition dump in the same area was hit by 20 bombs which started fires. XX Corps reported that the successful attacks facilitated the infantry's advance and that they knocked out some fortifications and led groups of enemy troops to surrender during the bombing.¹³

On 15 September, 5th Infantry Division instructed a covering squadron of 405th Group to bomb a crossroads near Fagny, south of Metz, where two tanks and 17 MT were destroyed; and on the 20th two more were destroyed near Fleury, where the area was blind-bombed. The 5th Infantry Division reported that hits were scored and a gun position destroyed. Joint efforts continued in the Metz area where forts were usually the objectives. The 405th Group delivered a series of attacks against these targets. On 20 September a squadron dropped Napalm tanks and bombs on Fort No. 1. On the 24th the fort at U-7753 was bombed and strafed by one squadron and hit again two days later by three squadrons whose bombs and Napalm tanks fired barracks. The next day (27 September) three stubborn forts were attacked--one by four squadrons and two others by one each. All were well hit and ground declared itself pleased with the results at U-7950. On 28 September 90th Infantry Division marked the fort at U-7858 with smoke, and 36 aircraft of 358th Group dropped 22 x 1,000-pound GP and 23 x 150-gallon Napalm bombs on the target. Direct hits were made and a fire started. Three other forts were hit by another mission on the part of 40 planes from the same group on this same day. Later, on 29 September, a

~~CONFIDENTIAL~~

squadron of 36th Group, assigned to cover units of XV Corps, was picked up by 90th Infantry Division of XX Corps and directed to attack the villages of Amanvillers and Semecourt which it successfully bombed and strafed. A pilot who bailed out in the course of this mission later reported himself safe and acted as a ground controller. On this day, also, a directed attack on troop billets in Maizieres les Metz dropped 22 bombs on the town and then strafed it, producing many fires.

The Nancy-Epinal Area

When 80th Infantry Division was attacking east of the Moselle between Pont a Mousson and Nancy, air cooperated at "Ironclad's" direction. At its request five towns in the area of its advance were thoroughly fired on the 15th by the strafing attacks of three squadron-strength missions from 373d FB Group, to which ground reported, "You are doing a damn good job strafing, keep it up." On the strength of this the squadron went on to silence two near-by gun positions.

On 13 September XII Corps was driving against Nancy from the west, and at its request one squadron of 36th Group silenced an 88-millimeter gun position, while another rendered a bridge unserviceable. The same day French armor expressed its thanks to 406th Group for its intervention in a tank battle near Dompierre, west of Epinal. Here ground confirmed the destruction of 15 tanks by one squadron which dropped four frag clusters and then strafed. Two other squadrons also attacked and destroyed five more tanks between them. The enemy's attack, delivered by 45 tanks with two infantry companies

in support, had threatened to overrun the French command post at Ville sur Ilion; but close liaison between ground and air, coupled with the speed and accuracy of the air strikes, had saved the day. ¹⁴ Later when XII Corps was moving east from Nancy towards Chateau Salins on 20 September, 4th Armored Division requested an attack on 20 tanks and as many LT southeast of the latter town. A squadron of 36th Group attacked. Its bombs accounted for five tanks and its strafing for five LT.

On the 24th the same division experienced a counterattack at Laneuveville en Saulnois, northwest of Chateau Salins, and instructed a squadron of 405th Group to attack an area in which there were 50 tanks. Weather was troublesome, but two tanks were destroyed by bombing, and near-by woods were strafed. Ground reported that air had repulsed the counterattack. On the 29th, 405th flew nine squadron-strength missions in cooperation with XII Corps and furnished several interesting examples of air strikes. Ground fog was heavy, but the planes struck with good results the towns of Jallaucourt, Malleucourt, and Fresones en Saulnois, as directed. At Chambery bombing was through clouds, but the violet smoke marking the target penetrated them, and ground reported good results. One squadron observed a tank battle near Arracourt. The 30 German tanks retreated at their approach; but one tank was destroyed, two probably destroyed, and four damaged, while the American ground column advanced. Another squadron was directed to a tank battle south of Haraucourt, where 20 to 30 enemy tanks faced an American motorized column. The squadron dive-bombed the tanks, destroying three and damaging one. It then strafed the woods in the

vicinity, believed to contain enemy troops, set fire to a house, and destroyed two half-tracks and a truck. The ground controller reported that the squadron also flushed six tanks which were knocked out by our armies and artillery.

General Elster's Surrender

An interesting episode connected with air-ground cooperation occurred on 16 September, when at the request of the commanding general of the Ninth U. S. Army, General Neyland, in command of XIX TAC, was present at the surrender of the German General Elster and 20,000 of his Marach Gruppe at Beaugency Bridge. General Elster and his forces were part of those elements of the German Wehrmacht in southern France which had sought to join the battle north of the Loire. Planes of XIX TAC, discharging their mission of guarding the southern flank of TUSA, had located the enemy, cut his communications, and prevented any effective action on his part. When on 10 September the negotiations were begun which led to the surrender as the columns eventually reached the Loire, General Elster had signified that he was ready to capitulate if a halt were called to air attacks. The attacks were stopped, but the constant threat of their renewal kept the German leader to his resolution. Air power had thus been the greatest single factor in forcing the final capitulation.

Attacks on Road and River Transport

Road targets were regularly subjected to attack in the course of armed reconnaissance by XIX TAC during the month of September. As previously, the net results were impressive, made so as the result of

the accumulation of numerous small claims. As in the case of IX TAC, the most extensive claims for the operations of individual days are found at the beginning of the period. On 1 September 405th Group flew six squadron-strength missions from Mezieres and Arlon to Thionville, Metz, Nancy, and Toul and claimed the destruction of 200 MT, 28 horse-drawn vehicles, 5 tanks, and 4 horse-drawn artillery. Two days later three of its squadrons claimed 63 MT, 3 horse-drawn vehicles, and 5 artillery pieces in the Saarbrucken-Strasbourg-Basle area. Even more striking were results achieved south of the Loire as the enemy streamed westward to escape the converging Third and Seventh U. S. Armies. On 1 September 36th Group earned a commendation from the Commanding General, XIX TAC. It had flown three squadron-strength missions in the Poitiers-Chateauroux-Clamecy area and had found a large convoy of mixed vehicles east of Chatellerault and others near Poitiers. They claimed the destruction of some 500 vehicles and damage to many more. On the 7th, 406th Group flew two group-strength missions, their assigned targets being a mixed convoy discovered near Chateauroux by tactical reconnaissance. Claims of over 450 vehicles destroyed were submitted. Later reports indicated that French Forces of the Interior took prisoner the remnants of the column. Incident to operations in this general region, planes of XIX TAC dropped propaganda leaflet bombs in the Chateauroux, Epinal-Dieuze, and Luxembourg-Chateau Salins areas (9, 11, 20, 29 September.)

Rhine barges on occasion offered good communications targets. One was destroyed and six others were driven aground by an attack from 373d

Group on 15 September; and on the 29th the same group destroyed 15, together with a tug. On the 29th, likewise, 362d Group was assigned barges at Bingen for dive-bombing attack. The assaulting squadron dropped 21 x 500-pound GP bombs on 14 oil barges. Large fires resulted, and six barges and a tug were destroyed.

Attacks by XIX TAC upon railway communications targets will be treated in connection with the interdiction program.

Actions against the GAF

Air Combats

Air combats between enemy aircraft and XIX TAC units were infrequent in September. A single enemy aircraft was shot down over Saarbrücken during a sweep of that area by 354th FB Group on the 10th, and another was destroyed when 20 enemy planes jumped 15 aircraft of 371st Group west of Karlsruhe on the 28th. The following day a squadron from 406th Group, while rail cutting near Landau, sighted 30 enemy planes. All dropped their tanks and 12 to 15 closed in combat in which the 406th lost two but claimed 6-0-3. Aside from such actions the air encounters of 12 September were outstanding. A squadron of 405th Group, covering the XII Corps near Pont a Mousson, was jumped by enemy planes and claimed 5-0-5 for the loss of two. Two formations of 354th FB Group had encounters in the Limburg area. One formation of 11 P-51's had attacked an airfield when it was asked to help another squadron; in complying it tackled at least eight enemy aircraft with resulting claims of 6-0-1. The second, with 15 P-51's, was bounced by over 40 FW-190's which had Me-109's flying top cover. The 354th's leader and his wing man sought to divert the covering formation, but no combat resulted. The balance of the formation, however, engaged in dog fights with the FW-190's and shot down 24 without loss as the enemy pressed his attack.

Airfields

A few actions resulted in the destruction of enemy planes on the ground. On 1 September the score was 2-0-2 after 10 aircraft of 406th Group strafed a Metz airfield which was their assigned target. A squadron of 354th Group claimed 1-0-1 after its attack on a Frankfurt field where heavy flak limited its attack of 12 September. The same day another of the 354th's formations strafed a field near Limburg where its claims of eight destroyed brought the group's total for the day to 39-0-3 in the air or on the ground. On the 27th a field at Gornersheim was strafed by 15 aircraft of 36th Group, which destroyed two enemy planes and left a hangar burning. XIX TAC control then gave them an airfield near Metz as a target, but lack of fuel prevented an attack. The next day 31 P-51's of 354th Group strafed three airfields in the course of a sweep. On one west of Spoyer they destroyed one and damaged another. No attack was delivered on a field northwest of Frankfurt since heavy flak would have rendered it unprofitable; but at Erbenheim, north of Mainz, and at a field south of Frankfurt scores of 4-0-2 and 2-0-0 were run up, with a glider also destroyed. In addition 354th Group set two fires on an airfield east of Weisbaden on this same mission. By such actions, and by the strafing of a field south of Metz on the 29th, the Luftwaffe was harassed and its capabilities in some measure reduced.

Recapitulation

In the course of September XIX TAC had flown 7,791 sorties and dropped 2,015 tons of bombs. It had conducted operations on all days

of the month save two, but its air activities had been considerably reduced by weather on 15 others. Against enemy aircraft its total claims were 32-0-5 in the air and 34-6-24 on the ground. Among ground targets claimed destroyed were 2,132 LT, 196 armored vehicles, 376 locomotives, and 892 railway cars.

In connection with all fighter-bomber activities during this month it is to be observed that the relatively stabilized warfare of the period presented few close cooperation targets. Accordingly, fighter-bomber effort was concentrated on armed reconnaissance against traffic supporting the enemy's attempted build-up along the West Wall. However, valuable assistance was rendered in protecting the American Moselle bridgehead against air and ground counterattacks; and in cooperating with limited objective attacks of the Twelfth Army Group all along its front. As usual, the American armies enjoyed an almost complete immunity from enemy air attacks during this period when they were regrouping, strengthening their supply situation, and coiling for another strike.

9th Bombardment Division

Air-Ground Cooperation

The Nancy Area

As previously noted, 9th Bombardment Division cooperated in the assault upon Brest in September 1944. It likewise engaged in air-ground cooperation at various points on the eastern front during this same period, although its activities of this and other types were considerably curtailed by weather. While the attack on Brest was

continuing, initial blows were delivered in the general area of Nancy. Elements of TUSA had crossed the Moselle to the north of Pont a Mousson and it was desirable that their southern flank be protected by denying to the enemy the use of the bridges at Custines and Pompey (north of Nancy) over which some of his forces to the west of Nancy might have moved to the Pont a Mousson area. Accordingly, on 10 September, 84 aircraft from three groups attacked the bridges and reported probable damage to both. On the 10th, and again on the 12th, German forces in the Forêt de la Haye were bombed in an effort to hasten their retreat eastward through Nancy itself. Each of seven groups was assigned a defended area in the forest on 10 September, and two days later four groups were sent against a total of seven targets, chiefly artillery positions. Bombing accuracy varied considerably in these attacks, and the wooded character of the area prevented any clear assessment of results. Later, on 28 September, part of one group bombed the Forêt de Parroy in cooperation with the 79th Infantry and 4th Armored Divisions. The attack had been scheduled but abandoned on each of the three preceding days, and on the 28th only 37 planes of the four groups assigned were able to complete their mission--with indefinite results.

Metz Attacks

On 11 September 9th Bombardment Division cooperated with TUSA in its drive against Metz. In morning missions seven groups struck at as many targets ranging from positions north of Thionville to others south of Metz. In the afternoon four of the same groups bombed four other targets in the same region. Thousand-pound GP's and 500- and

1,000-pound SAP's were dropped in the designated areas and inflicted some damage, although there was no evidence of serious effect on the concrete gun emplacements which constituted the bulk of the targets.

The Siegfried Line

In connection with VII Corps' advance against the Siegfried Line seven groups of bombers were dispatched on 12 September armed with 1,000-pound GP and 1,000-pound SAP bombs. Four attacked antitank barriers, artillery, and machine gun emplacements and lookouts in the Scheid area, and three others were sent against like targets near Echternach. At Scheid the bombs of 30 of the 112 aircraft attacking fell in the target area; while at Echternach, where 54 planes attacked out of 110 dispatched, reports were indefinite. Later, at TUSA's request, points in the Siegfried Line west of Zweibrucken were singled out for experimental bombing by 9th Bombardment Division. However, missions scheduled for the 16th, 17th, and 18th were not carried through, and on the 29th only 12 aircraft of the two groups dispatched dropped their 250-pound GP bombs. The results of this bombing were undetermined.

Action in the British Sector

On two occasions 9th Bombardment Division acted on the British-Canadian front. In the first instance German communications with their positions north of the Scheldt estuary were the objectives. Here a viaduct near Bath on the isthmus connecting Zuid Beveland with the mainland was the target for 77 bombers from three groups on 16 September. They inflicted severe damage and left the viaduct unserviceable. A second target on the same day was the embankment at Arnemuiden associated

with the span connecting Walcheren with Zuid Beveland. The attack here, delivered by 73 planes from two groups, scored hits on tracks, on the highway, and on the embankment itself. Later, on 30 September, the bridge over the Neder Rijn at Arnhem was bombed for the first time in an effort to deny its use to the enemy after the 1st British Airborne Division had withdrawn to the south bank. The 23 tons of 1,000-pound GP bombs dropped by the 14 aircraft of the group which had been dispatched did not damage the structure.

Leaflet Missions

In an effort to undermine enemy morale, 14 leaflet-dropping missions were flown during the month with from four to eight aircraft participating in each. Aircraft of a single mission were often assigned a very considerable area. For example, Ostend, Dunkirk, Calais, Boulogne, Le Havre, Brest, Crozon, Lorient, St. Nazaire, and Arras were assigned to eight planes of 391st Bombardment Group on 5 September. Pathfinder planes were almost exclusively employed for these tasks after 10 September.

Tests of the A-26

It should be observed that, beginning with 6 September, service tests of A-26 aircraft were carried on as a first step in their introduction as standard equipment for 9th Bombardment Division. Eight medium-altitude missions were flown, in the course of which no enemy aircraft were encountered and no strafing was attempted. The September tests were considered preliminary, and more extensive and thorough ones were planned, with an A-20 group re-equipped with A-26's and flying on missions assigned to units equipped with A-20 and B-26 type aircraft. ¹⁷

Summary

Including its activities against rail targets, which will be treated in connection with the interdiction program, 9th Bombardment Division as a whole operated on a total of 21 days during September, although the operational days of individual groups ran at the lower level of 9 to 14 days. A total of 5,390 aircraft were dispatched, of which 5,103 became sorties and 3,349 attacked. Movements to new fields, plus the foul weather of a European fall, were the main causes of this decline. Later it was determined that in the course of 40 days prior to 25 October, 25 per cent of the missions sent out had no appreciable weather difficulties. But on the other hand, 25 per cent of such missions were completely abortive, while another 50 per cent had the attacks on their primary targets reduced in strength by from 20 to 80 per cent because of adverse weather conditions. The number of planes dispatched was 59 per cent of the August figures and the number of those attacking, 62 per cent. Twelve aircraft were lost with 101 personnel casualties. A total of 5,591.125 tons of bombs was dropped which amounted to 53 per cent of the August total. Bombing accuracy deteriorated in some measure, due partially to the decreasing percentage of bomber crews which possessed extensive mission
18
experience.

Chapter VII

A NEW INTERDICTION PROGRAM, SEPTEMBER TO NOVEMBER 1944

Genesis of the Plan

Preliminaries

A new program of rail interdiction designed to isolate the battlefield west of the Rhine took form in the course of September and early October 1944. Its inception is found in a request on 8 September that Twelfth Army Group make an exception to established rules and cut rails to prevent enemy movement into the Siegfried Line. A day later the Army proposed a list of some 19 lines which, if cut, would produce the desired result; and on 10 September Advanced Headquarters Ninth Air Force issued orders assigning seven stretches of line to IX TAC and seven more to XIX TAC in the initial version of the new program. All 14 lines lay west of the Rhine and north of the rail crossings of that river abreast of Karlsruhe. The tactical air commands were directed to attack these targets and to persist in such assaults so that the lines might be kept continuously immobilized.¹

On 12 September a new feature of the program appeared when six rail lines, located east of the Rhine and converging on the river's crossings at Karlsruhe, Rastatt, and Strasbourg, appeared among the eight new lines assigned as targets of XIX TAC. Two days later five other targets of like character were given to XIX TAC, together with two others west of the river, and a substitution was made in the original seven lines assigned to IX TAC.² The list of lines to be

cut, as published on 14 September, was to remain in force until the 28th.

The Program of 14 September 1944

The program of 14 September provided for rail-cutting operations by fighter-bombers of IX TAC against seven lines extending westward from Rhine crossings at Dusseldorf, Koln, Remagen, and Koblenz. To XIX TAC were assigned 11 lines running west from Rhine crossings at Bingen, Mainz, Worms, Ludwigshafen, Speyer, Germersheim, and Karlsruhe, and another 11 lines east of the river leading to the rail centers at Karlsruhe, Fastatt, and Strasbourg. The full list of cuts as determined on 14 September was as follows:

INTERDICTION PROGRAM AS OF 14 SEPTEMBER 1944

Note: Lines which appeared on the initial lists of 10 September are marked *. Grid references are to Army/Air maps 1:250,000.

IX TAC (west of Rhine River)

*Julich F-0359 - Ameln F-0967
 *Julich F-0359 - Duren F-1148
 *Eschweiler K-9647 - Euskirchen F-3229
 *Sotenich F-1715 - Euskirchen F-3229
 *Ahrdorf L-3398 - Duppelfeld F-4205
 *Deun L-3678 - Mayen L-6292
 *Wengerchr L-4253 - Koblenz L-8996

XIX TAC (west of Rhine River)

*Hermeskeil L-4120 - Simmern L-8554
 *Heimbach L-6312 - Bad Kreuznach M-0635
 *Altenglan L-8003 - Lauterecken L-8917
 *Landstuhl Q-8890 - Kaiserslautern K-0194
 *Zweibrucken Q-7572 - Pirmasens Nord Q-9074
 *Landau R-2868 - Scheidt R-2551
 *Gernersheim R-4869 - Junction R-4059
 Kaiserslautern R-0395 Neustadt R-2082
 Hinterweidenthal R-0167 - Landau R-2766
 Pirmasens Nord Q-9074 - Kaiserslautern R-0093
 Gernersheim R-4869 - Worth R-3950

XIX TAC (east of Rhine River)

Durlach	R-5048	-	Graben	R-5463
Darleich	R-5048	-	Bruchsal	R-3258
Durlach	R-5048	-	Pforzheim	R-7033
Ettlingen	R-4839	-	Pforzheim	R-7033
Forbach	R-4510	-	Klosterreichenbach	W-5092
Gegenbach	W-2278	-	Hausach	W-3264
Kerlsruhe	R-4648	-	Tongraben	R-5561
Grotzingen	R-5443	-	Bretten	R-6949
Restatt	R-3623	-	Freudenstadt	W-5686
Offenburg	W-1686	-	Haslach	W-2666
Offenburg	W-1686	-	Lahr	W-0872

Development of the Program to 8 October 1944

In the period during which the directive of 14 September was in vigor, the importance of the interdiction program was stressed in two orders, those of 21 and 25 September. The first called for accent on the plan for rail interdiction since the enemy was transporting large quantities of equipment and personnel to the battle area by rail. The second provided that the tactical air commands should concentrate on rail cutting and consider such operations their first priority.³

Further consideration of the interdiction program by Twelfth Army Group and Ninth Air Force resulted in its revision and elaboration between 26 September and 8 October. The revision involved changes in the lines to be attacked and in the distribution of the new lines between the four tactical air commands (IX, XIX, XXIX, and XII) operating on the American front at this time. The elaboration of the program involved the addition to the revised lines for attack of another series lying farther to the east. The first was styled the inner line of interdiction, the second the outer line of interdiction. Cuts along the outer line would reinforce the dislocating effects of those made upon the inner line. By way of further

elaboration the Ninth Air Force requested that 2d TAF (RAF) be allotted the task of keeping cuts on northern extensions of both the inner and the outer lines, to render the interdiction program more complete in respect to communications leading to the entire battle area. On 29 September, when the outer line first appeared in orders, the points specified for attack lay beyond the existing tactical area, and therefore clearance by Ninth Air Force Headquarters was required before missions against them could be flown. This situation was remedied by the eastward extension of the tactical area's boundaries on 1 October. Thereafter the outer line was fully at the disposal of the Ninth Air Force for rail-cutting operations.

The changes described in the preceding paragraph were effected by a series of orders and messages. As a result, the program in vogue on 8 October was as follows:

INTERDICTION PROGRAM AS OF 8 OCTOBER 1944

Inner Line of Interdiction

IX TAC

Baal K-9772 - Junction F-0883
 Julich F-0359 - Ameln F-0867
 Duren F-1350 - Ellsdorf F-1759
 Duren F-1350 - Junction F-2757
 Norvenich F-2346 - Junction F-2855
 Euskirchen F-3529 - Liblar F-3645
 Euskirchen F-3529 - Stadtmeckenheim F-4925

XXIX TAC

Dorsel L-3398 - Junction F-3518
 Daun L-3678 - Meyen L-6392

XIX TAC

Wengerrohr L-4253 - Koblenz L-8996
 Hermeskeil L-4120 - Simmern L-8554

Nohfelden	L-5610	-	Sobernheim	L-9432
Homburg	Q-7180	-	Lauterecken	L-8917
Homburg	Q-7180	-	Kaiserslautern	R-0194
Thaleschweiler	Q-9014	-	Kaiserslautern	R-0194
Landau	R-2888	-	Neustadt	R-2884
Landau	R-2888	-	Speyer	R-5181

XII TAC

Graben	R-5563	-	Hockenheim	R-5980
Bruchsal	R-6359	-	Waldorf	R-6878
Bretten	R-7149	-	Eppingen	A-8661
Junction	R-8140	-	Beitigheim	S-0341
Pforzheim	R-7133	-	Calw	R-7114
Freudenstadt	W-5036	-	Eutingen	W-7587
Junction	W-3465	-	Villingen	W-5540
Freiburg	W-0933	-	Neustadt	W-3624

Outer Line of Interdiction

IX TAC

Hamm	B-0544	-	Neubeckum	E-2057
Soest	B-2631	-	Lippstadt	B-4242
Soest	B-2631	-	Belecke	B-4222
Junction	B-3206	-	Muttlar	B-4808

XXIX TAC

Junction	G-3669	-	Allendorf	G-6570
Junction	G-5258	-	Junction	G-7353
Staufenburg	G-6930	-	Colbe	G-7451
Junction	G-9225	-	Neder Gemunden	G-9333

XIX TAC

Stockheim	M-9193	-	Lauterbach	E-1727
Gelnhausen	N-0378	-	Schluchtern	N-2796
Aschaffenburg	N-0253	-	Lohr	N-3256
Wertheim	N-2931	-	Lohr	N-3256
Konigshofen	N-4407	-	Heidingsfeld	N-5932
Konigshofen	N-4407	-	Heimersheim	N-5700
Hall	S-4659	-	Crailsheim	S-7062
Schorndorf	S-3225	-	Aalen	S-7329
Flochingen	S-2414	-	Geislingen	S-5606
Heilbronn	S-0762	-	Junction	S-0672

Thus, under the arrangements in effect on 8 October the inner line was made up of 25 lines of which 17 lay west of the Rhine and eight east of the river; while the outer line was composed of 18 selected lines, ranging from Hamm in the north to Geislingen in the south, all of which were over 45 miles east of the Rhine. Although targets different from those of 14 September were selected to compose the inner line of 8 October, the same rail communications were affected in both cases. Generally speaking, all towns and especially the more populous termini of the listed sections were to be avoided because of flak. The sections were made as long as possible to offer a wide selection of points of attack, and multiple cuts on a single section were desired for maximum effect, even though it was held that a single cut on each of the designated sections would produce the result desired. By orders of 5 October, cuts and their maintenance were accorded first priority since, as in the case of the earlier interdiction program, the success of this plan depended upon the effectiveness of numerous cuts at any given moment.⁴

Addition of Bridges to Interdiction Targets

On 7 October previous instructions were canceled and all bridges on the U. S. front except those over the Rhine were opened for attack, with first priority accorded to those included in the rail sections assigned for cutting or to those whose destruction would duplicate the effects of rail-cutting operations.⁵ On 9 October an initial list of 10 bridges was given to the tactical air commands, and other individual structures appear in the operational orders of later dates.⁵ Later

(17 October) all Rhine rail and road bridges were cleared for attack, and on 18 October Twelfth Army Group requested that the significant battle area be isolated by the cutting of 17 listed rail bridges over the Issel, the Rhine, and the Moselle. If the Ninth could not attack the Rhine bridges north of Köln, it was suggested that heavy bombers be requested. First priority was for the moment accorded this program even if the diversion of fighter-bombers from air-ground cooperation should be necessary. In case the specified bridges could not be attacked, it was requested that the Ninth Air Force cut sufficient rail bridges on the inner line of interdiction to accomplish the same result. ⁷ The importance of the interdiction program was thus stressed and an added means of carrying it into effect was provided. On 19 October the operational order issued by Advanced Headquarters Ninth Air Force prescribed that for all tactical air commands rail cutting on the inner line of interdiction should have first priority and bridge cutting on the outer line second priority, and that these two ⁸ programs should take priority over all other commitments.

The Problem Defined

Certain facts must constantly be borne in mind in considering the development of the interdiction program and its execution in September and the months which immediately followed. Full success could be achieved only if all vital lines were cut and kept cut. In view of the extraordinarily complex nexus of lines in the German railway system, an intense and sustained effort was required. This was the more necessary because of the enemy's familiarity and skill in making

use of his transportation system, and because of his provision of an elaborate and efficient system for effecting needed repairs. It appears that on occasion he was able to restore, in a matter of hours, traffic over a line which had been cut. On the other hand, it was later learned that considerable damage was done to the rails themselves by the impact of 50-caliber projectiles used in strafing rolling stock. Constant vigilance was required of track walkers in this connection, for while the injury might appear superficial it was of a nature which might cause the eventual collapse of a rail and the consequent derailment of a train.

Furthermore, a full knowledge of the existing situation on the target sections was, as previously in France, an essential to effective planning of interdiction operations. Such knowledge was not available in the fall months of 1944. Pilot's reports were helpful, but frequent check-ups by aerial reconnaissance were a requisite. Visual reconnaissance was limited by many of the factors which lessened the value of pilots' reports. Photo reconnaissance was therefore of peculiar value. But weather, in the shape of the all-too-prevalent clouds and ground haze, reduced the amount and value of photographic evidence, just as it limited the amount and effectiveness of combat operations. Photo reconnaissance was further limited by the fact that on good days photographic units had tasks of extreme urgency to accomplish for the ground forces as well as for the air. Under such circumstances the operational direction of the interdiction program was beset by many difficulties, and the historian's endeavor to narrate its course and appraise its results is attended by as many more.

Accordingly, in the treatment of interdiction we must be content with sampling, with the description of a variety of missions, and with giving an indication of what could be done when full-scale operations were possible on a single day or on several consecutive days.

Interdiction Effort by IX TAC

September Activities

In the early days of September, when the interdiction program was taking form, IX TAC achieved considerable success against rolling stock on rails east of the battle area, as a few examples will indicate. On the 8th three squadrons of 404th FB Group attacked a heavy concentration in a marshalling yard northeast of Koln and destroyed six locomotives and 20 cars. A railway center at Julich was hit the next day by a single squadron of the same group which claimed 21 locomotives and 10 tank cars destroyed. On the 9th, likewise, one squadron of 365th FB Group strafed six trains and bombed another in the Bonn-Aachen-Koln area, another reported five locomotives destroyed, and a third claimed eight destroyed near Trier. A squadron from the same group blasted a 30-car ammunition train west of Koln and struck three trains south of Euskirchen on the 11th, while a squadron of 368th FB Group attacked five others on the line Scheid-Sotenich-Lissendorf. On the 14th a squadron of 474th FB Group spotted 10 locomotives pulling cars loaded with troops and equipment in the Eschweiler-Erkelenz area and claimed the destruction of nine locomotives. It should be observed that the only rail targets assigned for attack in these missions were the two marshalling yards. The others were selected by the leaders of

formations whose priority assignment was armed reconnaissance, air-ground cooperation, or--as in one instance--leaflet dropping. Throughout the month similar actions against rolling stock built up the altogether creditable total of 321 locomotives and 1,321 cars claimed destroyed.

IX TAC mounted a comprehensive rail-cutting effort on 10 September, the very day that the first list of rail interdiction sections appeared. Two areas and five lines were listed for attack. Included in the latter were five of the program's sections and another which did not figure in its listings. One line was to be attacked by two squadrons, while each of the others, together with each of the two areas, was assigned to a single squadron. An additional squadron was to provide top cover on one mission. Thus a total of nine squadrons (102 aircraft), all from 404th Group, was to be dispatched.

Multiple cuts were made on the sections Wengerohr-Moblentz and Sotenich-Duskirchen, both of which appeared on the 10 September list. Five others were scattered over a wide area. Rolling stock had offered attractive targets, and 24 locomotives and 120 cars figure among the total claims; but it is obvious that if interdiction were to be effective, efforts like that of 10 September would have to be made almost daily. Other commitments and weather did not allow this in the days which immediately followed.

Nevertheless, an example of sustained interdiction effort on the part of IX TAC is found in the nine-day period 21 to 29 September. Seven of these days were operational, and on each of them one or more missions were flown with rail targets as their special objectives.

~~CONFIDENTIAL~~

The total of such missions was 14, and all save one were of group strength. Their targets ranged from the Venlo area in the north to the Moselle River in the south. Rail cutting was clearly their priority assignment, although accounts of attacks on rolling stock figure in their reports.

Conservative claims of cuts indicate that their number and frequency along some lines were sufficient to constitute a formidable traffic obstacle. Such obstacles were probably established by the moderate concentration of cuts on lines extending to the northeast and southeast of Venlo, along those connecting Rheydt with Roermond, and on those in the immediate vicinity of Julich. Farther to the south similar effects were produced by like concentrations between Duppelfeld and Remagen, and on the line Wengerchr-Koblentz. Much more considerable results occurred in the rail complex within a 20-mile arc west of Koln where the concentration and the frequency of cuts were by all odds the heaviest. The line running west to Duren and the north-south lines between Bedburg and Zulpich were hard hit, as were those extending from Euskirchen north towards Koln and southeast towards Reichenbach. Cuts, some of them multiple, were reported at some 70 specified points during these seven days of operations, with others listed in general terms. It is of interest to observe that of the seven sections assigned to IX TAC under the formal program, only one--Wengerchr-Koblentz--was considerably affected.

During September a few cuts were made by IX TAC on lines east of the Rhine. Four group-strength missions were dispatched to this region, but weather prevented one from finding its targets. A mission on the

~~CONFIDENTIAL~~

22d reported six cuts on the line east of Dillenburg and six more on rails west of Marburg. On the 27th, when two missions were flown, several cuts were scored on the rails east of Lirburg and on those near Lullmenroth, where a bridge was also destroyed. Since the attacks could not be continued, the damage must be rated as incidental.

October Activities

In spite of its generally reduced scale of operations in October, IX TAC systematically pursued the interdiction program. On 15 days it sent missions to cut rails west of the Rhine (Green System) and on eight against those east of the river (Red System). Each mission reported cuts ranging from two to 17, with a total of 217 claimed during the month on these and other missions. By no means all of these were on the sections singled out for interdiction attack.

The missions were usually of group strength. On eight days two such missions were dispatched against the Green System and on three days the same weight of attack was delivered against the Red rails. On the last two operational days of the month a particularly notable effort was made when on the 28th six group-strength missions and one of squadron strength were dispatched, and on the 29th nine of group strength. On both days, particularly on 29 October, the attacks were concentrated on lines west of the Rhine, with priority given to bridges.

In view of their decidedly unusual weight, the attacks of 28 and 29 October are worthy of analysis. A total of 534 aircraft was dispatched--231 on the first and 303 on the second day. Five bridges were

claimed destroyed, four on the line Ahrdorf to Remagen and one between Norvenich and Mdrath, west of Koln. Damage in varying degrees was done to three other bridges on the Norvenich-Mdrath section, and to five in that from Ahrdorf to Remagen. Cuts were made at 11 specified points on the 29th and at 18 on the 29th, with concentrations in the areas just west of Koln and east of Luskirchen and on the rails from Ahrdorf to Remagen. A single group of P-38's struck at lines east of the Rhine and effected cuts in three places in the Rotenburg-Paderborn area. Weather prevented only one group from attacking rails.

The small size of the bridge targets helps to explain why they so often escaped destruction; and it should be remembered that when they escaped injury, damage to their approaches and to rails in their immediate vicinity was considerable. Moreover, it is clear that as the result of heavy attacks on these two days the lines Remagen-Ahrdorf, Mdrath-Norvenich, and Bedburg-Duren were put out of commission, at least temporarily, by rail cuts and by the destruction of small bridges. On the other hand, it is evident that success on such a scale was not regularly achieved, either because effort could not be so concentrated as on 28 and 29 October, or because of adverse weather. The attacks of these two days indicate what could be done when circumstances were
10
favorable.

November Activities

In November IX TAC's interdiction operations were on a limited scale, partly because of the demands of the American drive towards Koln, but to a greater degree because of continued adverse weather. Many

planned missions were canceled, while others which were dispatched were prevented from carrying out their assigned tasks. However, between 3 and 11 November, 13 missions attacked rail targets as did six others between 18 and 26 November. Of these six, all of group strength, bombed at points east of the Rhine. They struck the marshalling yard at Dillenburg (26 November), claimed the destruction of bridges near Elsaftthal (18 November) and Fredeburg (19 November), and reported a few widely separated rail cuts, none of which were on sections listed in the formal program.

The remaining 13 missions struck at rail targets west of the Rhine. Most of these were in group strength and had rail targets specifically assigned. They hit railway centers near Euskirchen and Mechernich and partially blocked a tunnel near Ahrweiler (3 November), while two bridges near Horren were claimed destroyed (11 November). Rail cuts, largely effected in the period 3 to 11 November, were concentrated on lines between Köln and Aachen and upon rails to the east and west of Euskirchen. Such concentration, because of the areas struck and the timing of the strikes, may have had some effect upon the enemy's transportation. It cannot be rated as significant, however, since the total of cuts claimed for the entire month was only 70.

Interdiction Effort by XIX TAC

September Activities

XIX TAC hit rail targets associated with interdiction on many of its September missions. The targets of any day's operations were varied and emphasis shifted from one type of target to another as

opportunity offered. No sweeping generalizations are possible, but examples will serve to indicate the character of the work accomplished.

On 13 September, as the interdiction program was being inaugurated, 405th Group dispatched a total of 63 aircraft on five armed reconnaissance missions, each of approximately squadron strength. These missions attacked rail targets in general. Three of them reported cutting rails in the vicinity of St. Die, Colmar, and Nohfelden in the course of attacks which ranged from Nohfelden in the north to Mulhausen in the south. Only the cuts near Nohfelden stood in immediate relationship to the formal program. Marshalling yards were special objectives chosen by each mission, and those at St. Die, Kochern, Zweibrucken, Homburg, Colmar, and Nohfelden were bombed. As the result of bombing and strafing a total of 23 locomotives were claimed destroyed in the yards or in attacks upon individual trains, and other rolling stock was destroyed or damaged. On the 22d the same group sent out three squadron-strength missions, with rolling stock earmarked for special attention. They operated along the lines Saarburg-Zabern-Brumath and Saargemund-Hagenau with conspicuous success, as evidenced by their total claims of some 10 locomotives and 103 railway cars destroyed. An ammunition train, one made up of 30 oil gondolas, and another whose 20 cars were freighted with tanks were among the targets attacked. No cuts were reported except those in the vicinity of Brumath and at Zabern; nor do cuts appear conspicuously in any reports until the closing days of the month, although missions against rail targets were flown on at least a dozen days in September.

Then a significant example of rail cutting activity on the part of XIX TAC aircraft is found in the operations by two of its groups during the three days 27 to 29 September. During that period 406th Group dispatched 13 missions which attacked rail interdiction targets, and 362d Group dispatched 16. All were of approximately squadron strength (12 to 16 aircraft) and involved a total of 403 planes. A grand total of 59 cuts was reported--21 by 406th and 38 by 362d FB Group. Their distribution is of interest. Thirteen were on lines specified for rail cutting in the formal program, and six others were closely associated with such lines. A single cut was on the line Daun-Meyen. Four lay along the line Wengerohr-Koblenz with another just west of Wengerohr. Two were made on the Hermeskeil-Simmern line, and four on that between Altenglan and Lauterecken, with three others south of Altenglan. Two cuts were effected between Landstuhl and Kaiserslautern, with two others just west of Landstuhl.

No cuts were attempted east of the Rhine and more than two-thirds of those made lay west of the western termini of the listed interdiction sections. However, the more notable concentrations were directly related to vital rails over which the enemy positions east of Luxembourg and in Alsace received reinforcements and supplies. The line parallel to the Luxembourg frontier between Lissendorf and Trier was cut in three places. Lines within a 20-mile arc from Saarbrücken, including Saarlautern, Ottweiler, Neunkirchen, and Zweibrücken, were cut in 13 places. Those between Bitsch and Haguenau and between Saargemund and Haguenau were each severed in three places. Eight cuts were made on the rails connecting Saarburg with Brumath,

and four on lines leading to Metz from St. Die on the west and Schlettstadt on the south. As a result of these cuttings on three days of more than ordinary interdiction operations against vital lines, a considerable volume of the traffic from the Rhine crossings between Koblenz and Strasbourg to the battle area was at least temporarily affected.

Other results accrued from attacks on rolling stock and rail facilities in the course of these same missions which further increased the enemy's problems of supply and communications. A total of 44 locomotives were claimed destroyed in the three days' operations. The Red Kreuznach marshalling yard was hit by 22 x 500-pound GP bombs dropped by 362d Group on the 20th. These caused an ammunition and tank car train of 30 cars to blow up, producing great fires in adjacent warehouses and a heavy explosion after the planes had left the target. A squadron of 406th Group on the 27th strafed an ammunition train west of Regennu. One plane was destroyed by the resulting blast, and other explosions--apparently from an ammunition dump--were observed over a
12
five-mile area.

October Activities

In October XIX TAC contributed to the interdiction program by cutting rails, destroying bridges, and attacking marshalling yards. It was a month of restricted operations in general, and those against railway targets were no exception to the rule.

The "Opreps" for the period disclose the fact that two of XIX TAC's groups--334th and 362d--possessed a virtual monopoly of rail

cutting during the month. A few cuts were made by 362d Group east of the Rhine, and a dozen or more in the same area were specified by 354th Group. They were scattered from the Wiesbaden and Frankfurt area in the west to Zerlstedt and Würzburg in the east. Neither their number nor their concentration was sufficient to produce any marked effect upon the German transportation system.

A greater number of missions which had rail cuts as a feature were flown west of the Rhine. In their reports the stereotyped phrase "some rails probably destroyed, many damaged" appears time and again and suggests considerable, although indefinite, results. A charting of cuts for which grid coordinates are given indicates that a few were effected in the area east of Metz and in the vicinity of Saarburg. Others temporarily broke the lines leading into Kaiserslautern from the west and those extending eastward from that center in the direction of Bad Kreuznach, Worms, and Neustadt. Some interrupted traffic on the rails leading southeast from Trier, but the most conspicuous concentration was on the lines Trier-Koblenz, where the relationship of the cuts to the formal program was most in evidence. In other instances such relationship is difficult to discover, although the lines attacked were clearly serving the battle front. Four tunnels were hit in the course of these operations with results claimed good.

Bridges were subjected to attack by various groups. Because of their location over water or in valleys these targets were often hidden by mist or cloud, and numerous missions were forced to seek other objectives. When attacks were delivered the bridge structures on

occasion escaped injury, but effective results were obtained on approaches and rails near-by. In spite of such disappointments, however, some definite results were obtained on bridges in the Saar area. At Herneckel 13 planes of 362d Group knocked out a bridge on the 13th. On the 28th a structure near Kaiserslautern was destroyed by three direct hits made by 1,000-pound GP bombs dropped from 43 planes of 358th Group. On the next day 38 aircraft from 362d Group damaged the structure at Hochspeyer (east of Kaiserslautern), and 45 planes from the same group destroyed that at Firmasens, together with a locomotive and 15 cars which were crossing the bridge at the time the attack was made. In Alsace elements of 405th Group bombed a bridge north of Hagenau on the 26th, 28th, and 29th and destroyed one span, while on the 29th two other bridges were hit. At Kaltenhausen (near Hagenau) 405th Group left the bridge unserviceable after two squadrons attacked, while 32 aircraft of 406th Group smashed the Schlettstadt (Selestat) bridge north of Colmar.

Railway centers and marshalling yards appear to have been favorite targets in October when over 25 were attacked either as designated objectives, or more often, as objectives selected by the leaders of elements on armed reconnaissance and other missions. On the two days 14 and 15 October squadrons from 405th Group struck six east of the Rhine--one southeast of Mainz, two in the Heidelberg area, one at Forbach, and others north of Lohr and east of Stuttgart. In Alsace five were bombed in squadron-strength attacks--Saargemund by 362d Group (2 October), Kriechingen by the 358th (2 October), Saarunion by the 362d (20 October), and Ingweiler and Pfaffenhofen by the 358th

(26 October). The remaining targets of this type lay within the Saar area. Here the more significant yards attacked were Simmern (2, 6, 13 October), Searbrücken (2 October), St. Wendel (3, 13 October), Landau (6 October), Hermeskeil (13 October), three rail yards east of Bad Kreuznach (14 October), and Speyer (28 October). Of these attacks those on Landau, Kaiserslautern, and Speyer were delivered by elements of 406th, 405th, and 367th Groups respectively; all others were made by units from 362d Group. The effects of such attacks in damage done to rails, rolling stock, and facilities were generally satisfactory.

Traffic and facilities on the Rhine-Marne canal were hit by 358th Group on the 7th and by 362d Group on the 9th with claims of some 24 barges destroyed, 50 or more damaged, and locks and banks considerably damaged. Six Rhine barges were claimed destroyed by an attack of a squadron from 358th Group on 13 October.

Rolling stock was often hard hit in the course of interdiction and other operations, notably on the following occasions. On 3 October a squadron of 405th Group, assigned to operate with XX Corps, was vectored to two trains south of Trier, hitting both with good results; on the same day 11 locomotives were claimed by a squadron of 362d Group in the course of a rail-cutting mission. Three days later a three-squadron mission of 406th Group included among other rail targets three trains at Ffeddersheim. On the 13th, when 12 aircraft of 362d Group bombed the marshalling yard at Kirn, they likewise strafed a 20-car ammunition train which exploded and burned; and in the course of three squadron-strength rail-cutting missions on the next day 354th Group destroyed four trains, one a 30-car ammunition train. Once again, however, the total claims against rolling stock are built up

13

chiefly from numerous small claims.

November Activities

Over-all operations on the part of XIX TAC were further reduced in November and those related to interdiction were affected in marked degree. Few missions which had rail cuts as their assigned purpose were carried through. Cuts described by coordinates all but disappear from the records, and general claims are the exception rather than the rule. While attacks on bridges occasionally figure in the records, no instance has been found of any carried out with marked success.

Marshalling yards again figure rather prominently among such rail targets as were attacked. West of the Rhine, Ober Roden (southeast of Frankfurt), together with Gemunden and Sachsenheim, were hit by squadrons of 405th Group on 25 November. Explosions followed the bombing and strafing of the latter two. On the 19th 353th Group hit the yard at Rastatt, east of the Rhine, and also at near-by Lauterburg on the west bank. On that same day two yards near St. Gear, on the Rhine above Koblenz, were struck by an element of 362d Group. Yards at Schlichtigheim, near Strasbourg, were attacked by 358th Group on the 16th, and six locomotives, together with 45 cars and sundry buildings, were claimed destroyed. Another Alsatian target was the yard at Colmar which the same group struck on the 21st. Five of the remaining railway centers attacked lay within a 20-mile radius of Saarbrücken. A squadron of 362d Group destroyed seven ammunition cars at Fargerten on the 9th. The 405th Group hit the same target on the 19th, together with the yard at Saargemund, and claimed a total of 12 locomotives destroyed. Fires

followed the strike at Merzig by the 362d Group on 15 November, and three days later an element of the same group claimed a locomotive and 30 cars at Neunkirchen, to which it had been vectored. A center near Lebach was bombed by 362d Group on the 20th. Still in the Saar but farther to the east, the yards at Winnweiler were hit by the same group on 19 November.

Damage to rolling stock has been noted in connection with attacks on marshalling yards. It likewise appears in the claims reported by other missions which include items such as the following. On 18 November, 404th Group claimed 15 locomotives destroyed by Napalm bombs and strafing near Wittlingen. On this day XIX TAC ran up its highest score to date for destruction of railway cars, claiming 456, together with 74 locomotives. In the course of four squadron-strength missions on the next day, 354th Group claimed 13 locomotives and as many rail cuts. The 354th reported 21 locomotives destroyed in the Saar area by two squadron missions on the 20th. On the 25th, 405th Group reported a train and six locomotives destroyed near Heidelberg, while on the following day 354th Group claimed 12 locomotives and 10 rail cuts in a 21-plane mission east of the Rhine.

Interdiction Effort by XIX TAC

October Activities

XXIX TAC's October operations associated with the interdiction program were limited by weather which eliminated all activities on many days and restricted them on others. Yet interdiction was given attention both by missions which were assigned that task and by many others which made rails their targets of opportunity. Many cuts were effected, but

only those cases where they were reported by means of coordinates can be dealt with here.

West of the Rhine incidental and sporadic action against rails is often to be observed, but on 8 October and again on the 13th and 14th there was a notable concentration of effort on these targets by missions dispatched with varied purposes. On the 8th a squadron mission of 373d Group probably destroyed a bridge at Dumpelfeld and cut rails on either side of that town, while 36 aircraft of 36th FB Group effected some half dozen cuts in the area west of Köln. On the 13th one 24-plane formation and another of 36 from 36th FB Group, together with one of 36 aircraft from 373d Group, made rails their principal targets; while several formations of 366th FB Group delivered incidental attacks. The following day 373d Group flew two attacks of 31 and 34 planes, respectively. Concentrations of cuts on these two days put several lines out of action for the time being--Erkelenz-Eheydt, Köln-Duren, Duren-Bedburg, Euskirchen-Bruhl, and Kyllburg-Gerolstein. Other cuts interrupted traffic in the vicinity of Rheinbach, southeast of Euskirchen. Here was an example of what might be done under propitious conditions.

Bridges west of the Rhine were often designated or selected for attack. One at Rech and another on the Luxembourg frontier west of Echternach were claimed destroyed in attacks on 7 October by squadrons of 378th and 366th FB Groups, respectively. On the 8th, as already noted, the structure at Dumpelfeld was probably destroyed by a squadron of 373d Group, and a like result was reported on the 15th following a group attack by the same organization. A bridge north of Remagen was

destroyed by 33 planes of 36th Group on 19 October, and five direct hits scored by the 373d in a group attack knocked out a bridge near Grevenbroich on the 28th. The following day a group attack by the 36th left a bridge near Julich unserviceable but standing; and 404th's group-strength strike at the structure near Herren, west of Koln, registered direct hits.

On occasion Rhine barges were attacked by XXIX TAC, as when a group and a squadron mission of 373d Group attacked on the 6th and the 11th, each reporting two destroyed. On 11 October, 35 aircraft of 366th Group destroyed nine and damaged eight other barges in the Koblenz area, while on the 28th a group mission by the 38th in the Dusseldorf-Koln region claimed 16 barges, one tug, and one steamer destroyed.

Between 6 and 29 October XXIX TAC dispatched eight group-strength missions against rails east of the Rhine, another group selected rails there as its secondary target, and a 24-plane mission cut rails both east and west of the river. The operations took place on seven different days. With the exception of one mission on the 20th which did little damage and two on the 28th which cut rails in the vicinity of Scest, on the line Arnsberg-Merchede, and farther south in the Sigmaringen area, all these efforts fell within the period 6 to 17 October. Two lines specified in the formal interdiction program were cut at Scest-Lippstadt and Colbe-Staufenburg. Rails on lines Allendorf-Grankenburg, and Leasphe-Colbe, closely related to other sections in the program, were likewise severed in the other concentrations of the period. Enough damage was done on these lines to have interrupted

traffic on the sections for a time, but in the absence of attacks in the latter portion of the month service was probably fully restored and maintained. It is of interest to observe that in the two group-strength missions by 36th Group on the 7th 15 locomotives were claimed destroyed.¹⁵

November Activities

In November the combination of bad weather and the tactical needs of the ground forces drastically reduced interdiction operations on the part of XXIX TAC. No such concentrations of cuts on rail lines as were effected in October were reported. In fact, reports of specified cuts are few; and those which were claimed are so separated in time and area as to be of negligible value. A total of 98 cuts was reported for the month. Attacks on bridges continued. In the area east of the Rhine, one bridge south of Kassel was destroyed by 36th Group (5 November) and another southeast of Heidelberg by the 404th (9 November). West of the river the destruction of a bridge near Grevenbroich was claimed by 48th FB Group (8 November) and another near Julich by the 36th (19 November). Other attacks upon such structures produced less decisive results. Such attacks as were delivered on marshalling yards lack significance in connection with interdiction.

Interdiction Effort by 9th Bombardment Division

September Activities--Marshalling Yards

Just as rail cutting on specified lines was the special assignment to IX and XIX Tactical Air Commands in connection with the interdiction program in September, so attacks on marshalling yards marked the

interdiction effort of 9th Bombardment Division in that period. The purpose of the bombers was to impede rail movement from Rhine centers to German positions farther to the west, and to restrict the enemy's capability to move troops laterally from one point to another along the front. If the effort were successful it would force the enemy to a greater use of motor transport, place added strains on that service, and drain his restricted supplies of fuel. In keeping with such purposes 9th Bombardment Division attacked 11 different marshalling yards in the course of the month, in the expectation of blocking traffic and of destroying facilities, together with such supplies and military personnel as might be found in the storage or transshipment areas associated with the yards or located on their crowded sidings. Only one of these targets (Bingen) lay on the Rhine itself--the others were situated in relatively close proximity to the battlefront between Aachen and Trier. All were related to the railway lines connecting the Rhine centers with the front, while six lay along main lines parallel to the front between Julich in the north and Trier in the south. The fact that nearly all the marshalling yards singled out for bombing lay in FUSA's area indicates the priority on air effort which its operations enjoyed during the period.

Four of the yards attacked were part of the rail complex serving Aachen immediately. On 19 September two groups attacked Luren with 79 aircraft, and one bombed Eschweiler with 37. In both cases all through tracks were cut at least once, and incidental damage was done to buildings and rolling stock. Julich and Luskirchen were assigned to four and two groups, respectively, on the 29th. Bombs from 45 of the

66 aircraft which attacked blanketed the target area at Eschirochen. The 121 planes which dropped more than 326 tons of 1,000-pound GP's on the sorting sidings and near-by warehouses at Julich inflicted damage whose exact nature was unassessed.

Six other marshalling yards were immediately related to positions in the Siegfried Line along the Luxembourg frontier between Aachen and Trier. On 19 September a single group sent against Bittburg attacked with 24 aircraft whose bombing destroyed three warehouses and damaged a barracks. Although some tracks were cut, through traffic apparently remained possible. At Trier a full group bombed on the 20th, probably blocked all lines, and damaged both rolling stock and transshipment sheds. The following day Fronsfield, Gerolstein, and Ehrang were the objectives of group-strength attacks. No damage was done by the 14 planes which bombed Fronsfield. At Gerolstein 29 aircraft destroyed rolling stock and almost completely blocked traffic, while the 36 which attacked Ehrang scored 80 hits in the target area, making through traffic impossible and destroying or damaging approximately 100 freight cars. On 29 September Frons received a first attack and Bittburg a second. Thirty-five A-20's blanketed the Frons target area with their 500-pound GP bombs. At Bittburg a barracks area, reported to house green troops awaiting movement to the Siegfried Line, was heavily damaged by the 65 planes of the two groups which attacked; and 52 aircraft from two other groups which struck the marshalling yard left its facilities completely unserviceable and damaged adjacent warehouses heavily. On the 29th, likewise, bombs from some 30 of the 72 attacking A-20's probably

inflicted heavy damage at Eingen, which served as a Rhine base for enemy troops in the Metz area. Earlier, on 12 September, two groups were dispatched to hit a special rail target at St. Wendel, north of Saarbrücken; but only 14 aircraft attacked, with no damage effected.

It is to be observed that operations against marshalling yards were confined to four days (19, 20, 21, 29 September). Numerous other attacks on marshalling yards were scheduled, but were either canceled or aborted, largely on account of weather, which so often prevented the effective conduct of the interdiction program in the course of September. 17

October Activities--Bridges

During October, 9th Bombardment Division gave its attention almost exclusively to communications targets, among which railway bridges were most prominent. Such accent was in keeping with the interdiction program for the period, but on occasion tactical considerations led to the choice of such targets.

It was the ground situation which caused 9th Bombardment Division to be given several transportation targets in Holland, an area in which the Ninth Air Force did not ordinarily operate. Here the Allied salient extending to the IJssel Rijn at Arnhem required protection. The bridge at Arnhem itself, which 9th Bombardment Division had unsuccessfully attacked on 20 September, was twice assaulted to deny its use to the enemy. No damage was done by the group attack on 6 October, but on the following day another group destroyed the structure. In an effort to block the enemy's attempt to strike the salient from the east, three communications targets were scheduled. A group bombing on the 12th hit

Venraij highway junction so well as to win commendation. The next day the rail bridges at Venlo and Roermond were each bombed by a group of A-20's which destroyed the structure at Venlo and left that at Roermond unserviceable. Mungelo marshalling yard was somewhat farther removed from the Arnhem area but nonetheless served it. On 6 October bombs from two groups fell on the city rather than on their rail target, but on the 7th a single group inflicted considerable damage upon rails, rolling stock, and facilities.

The desire to block the supply route of the German forces in Walcheren Island caused one group to be sent against Moerdijk bridge and another against that at Gertruidenberg on the 20th. Led by pathfinders, the attacking planes claimed to have rendered the first bridge unserviceable, but did no damage to the second. Prior to its destruction by the Germans, Moerdijk was again attacked by 9th Bombardment Division on the 29th, but the 33 aircraft attacking claimed only slight damage.

Attacks in the American area were more directly related to the interdiction program. In view of the current ground effort these were largely concentrated in the Aachen region where a marshalling yard and four railway bridges were attacked. The bridge at Lusirchen was bombed five times (8, 9, 13, 17, 29 October) in group strength. Two attacks reported no damage, two more reported their results unknown, while the bombing on 13 October left the bridge serviceable but blocked the lines temporarily. Grevenbroich bridge was not hit by the group dispatched on the 8th, and remained undamaged after a second bombing by a group on the 12th. Tracks were cut when a group bombed the bridge at Ahrweiler on 12 October, but only 13 aircraft bombed out of the two groups dispatched

on the 28th--and these did no damage. No damage resulted from the bombing of the structure close to the Rhine at Sinzig on the 28th. Two groups were assigned to each of three areas at Duren on 6 October and their reports were gratifying. An ammunition dump was blanketed, a barracks area was severely damaged, and the marshalling yard itself well hit. Julich, another road and rail center serving Aachen, was hit by bombs of six flights from two groups on the 8th, while those of one flight fell on Geilenkirchen marshalling yard. Between the Aachen and the Metz area four railway bridges and one highway bridge were bombed in the course of six group-strength attacks, none of which were reported to have vitally damaged the structures. Mayen was bombed on the 13th and again on the 29th. On the main line Koblenz-Trier, Bullay was attacked on the 7th and Eller on the 29th; while on the latter date a rail and a road bridge at Konz Kartheus, southwest of Trier, were also attacked. Considerable success was, however, reported after an attack on warehouses in the Trier marshalling yard (7 October) which supplied German divisions opposing the advance of the 26th Infantry and the 5th Armored Division. Three groups of A-20's attacked, destroying six warehouses and severely damaging four others.

In the area more closely related to the Metz front the bridge at Dillingen, on the main line from Trier to Saarbrucken, was destroyed by the group which attacked on 7 October, and that at Bad Munster was left unserviceable after a group bombed the following day. In this area, as in the others, enemy supplies offered targets, and on the 12th three groups bombed the Camp de Bitche and claimed severe damage to at least a quarter of the target area.

These attacks on transportation targets in October had not achieved conspicuous success, and their contribution to the interdiction program was but slight. Missions had, however, been flown on 10 different days, one or more on nearly every day which permitted combat operations. In many instances weather had forced the use of pathfinders. ¹⁸

November Activities--Bridges

Rail bridges at 13 key points on the lines serving the German front were the targets assigned to elements of 9th Bombardment Division for interdiction attack on 21 occasions during November. Five were bombed on the 2d, five on the 3d, and four on the 11th. Single groups were dispatched in all cases and, with one exception, 23 to 32 aircraft bombed. In the exceptional case only five attacked. Single attacks on the bridges at Bullay (2 October) and Ahrweiler (11 October) resulted in no appreciable damage, nor were greater results reported following the two attacks on Meyen and on Luskirchen (2, 11 October). Later in the month the Rhine bridges in the 6th Army sector at Breisach (18 October) and Neuenberg (18, 19 October) were bombed without effect. In the case of the remaining seven rail structures attacked, the results of at least one of the attacks delivered on each was more satisfactory. A first attack on Konz Kerthaus (2 October) rendered the bridge unserviceable, though that on the following day did not add to the damage. At Trier-Fulzoi (2 October) half of the span was dropped into the river, and Bad Munster was severely damaged on 3 October. Results of the bombing of Morcheid and Kaiserslautern (3 October) were

at first reported as undetermined, but in later records vital damage was claimed. The same holds true of results at Neuwied-Ihrlich (3 October) and Sinzig (11 October). Both these bridges were subjected to further bombings, but the attacks on Neuwied (19, 21 October) and on Sinzig (21, 23 October) were inconclusive.

Summary for the Period September to November

The interdiction program was planned on a grand scale. No less comprehensive plans could have promised to produce the desired results upon the intricate German rail network. But more than ordinary effort, as well as continued success in such effort, were both required if the battle area were to be truly isolated. Not even in September and early October, when the varied types of interdiction effort were most manifest, could the endeavor be rated as extraordinary. For the better part of October and throughout November its scale was even less, for at no time did weather and other factors permit interdiction attacks to become a part of the daily routine of Ninth Air Force elements. Temporary achievements in some areas were recorded in the course of interdiction operations in these months. But the enemy's skill in using his railway network and his ability to effect speedy repairs were such as to classify the over-all results as "interruptions of traffic" rather than as "interdiction" of the sort earlier achieved within the Seine-Loire arc.

Chapter VIII

OPERATIONS IN OCTOBER AND NOVEMBER 1944

Major Ground Force Actions

During the months of October and November 1944 the ground forces developed four major actions. In October a push against Aachen by EUSA resulted in the encirclement of that stronghold on the 16th and its surrender on the 21st, while in the south EUSA moved across the Saale in the direction of Chateau Salier. On 8 November EUSA inaugurated an assault which led to the capture of Metz, carried across the Moselle to Siegfried line positions in the north, and reached positions farther south to the west of Forbach, Puttelange, and Stavelot. On 10 November the First and Ninth U. S. Armies jumped off in the Aachen area and moved steadily forward to new positions just west of the Saar River.

Ninth Air Force Movements

Movements of the headquarters of Ninth Air Force and its elements, together with further forward displacements of its combat units, took place during this period. Main Headquarters Ninth Air Force remained fixed at Chantilly, but the advanced headquarters followed that of Twelfth Army Group to Luxembourg on 10 October. In keeping with this move, Headquarters 9th Bombardment Division left Chartres and on 23 October established itself at Reims, where communication with Advanced Headquarters Ninth Air Force and with its own echelons was simpler. Earlier, on 2 October, IX EUS moved its advanced headquarters to

Verriers, where it continued in residence. Advanced Headquarters XIX TAC was established at Nancy on 12 October, and as noted below, that of the new XXIX TAC was located first at Arlon (1 October) and after 22 October at Namur. Association with the headquarters of appropriate armies was in evidence in connection with each of the tactical air commands.

The 98th Bombardment Wing, within 9th Bombardment Division, moved to its third continental area when its elements settled down at Combrail-Merygnies, Peronne, Clastres, and Loos-Mithier in the course of the month. While two groups of IX TAC remained in the Reims area throughout October, on the 1st 474th TB Group joined the 370th which had preceded it to Florence, and the 355th and 368th moved eastward to Chievres by 4 October. Toward the end of November, 306th TB Group shifted from Loos-Courron to the Belgian field at Asch. XIX TAC units continued at their earlier locations throughout October; but on 5 November 303d TB Group moved forward to the neighborhood of Verdun, and between 20 and 29 November 354th TB Group advanced to Trierres en Meuse, northwest of Nancy. By the end of October the fighter-bombers of XXIX TAC were based on Belgian fields in the region of Le Gulot and St. Erand, where they continued throughout November. Each of these movements involved an improvement of operational facilities, inasmuch as the new fields were appreciably nearer the front than the old.¹

Appearance of XXIX Tactical Air Command

In the opening days of October the Ninth U. S. Army joined Twelfth Army Group on the front. Anticipating its appearance there, a new

tactical air command of the Ninth Air Force had earlier appeared upon the scene so that each army of Twelfth Army Group might have a command of this type associated with it. On 14 September 1944, XXIX Tactical Air Command (Provisional) had been activated at Verdun, near St. Quentin. Brig. Gen. Richard E. Nugent was announced as its commanding general, and the personnel of its headquarters and headquarters squadron were derived from 84th and 703d Fighter Wings. During the initial phase of its existence, XXIX TAC was attached to IX TAC for organization, training, and operations.³

At Verdun the personnel personnel of XXIX TAC perfected their organization and, in association with four groups of IX TAC, developed their operational techniques without actually assuming the direction of operations. By 3 October, however, headquarters of the Ninth U. S. Army had been established at Arlon and had taken over the southern sector of the old VIII front. Matching this development, XXIX TAC had opened operational headquarters at Arlon on 1 October, on which date the 36th, 366th, and 373d TG Groups, together with the 303d Tactical Reconnaissance Group, were assigned to it. With the establishment of its headquarters at Arlon, XXIX TAC was relieved of its attachment to IX TAC for organization, training, and operations, although in the weeks which immediately followed, certain of its groups were on occasion to be placed under the operational direction of IX TAC. Such action was the more justified because the front with which XXIX TAC was associated was comparatively quiet.³

Neither the Ninth U. S. Army nor its associated tactical air command

was long to remain in its first operational area. The army was switched to the extreme northern flank of the American front, and inevitably XXIX EAC moved with it. On 22 October, therefore, XXIX EAC established its headquarters along 11- line of the Ninth U. S. Army at Moutfriedt in Holland. Effective that date, 318th IB Group returned to IX EAC; but 398th and 373d IB Groups and 3021 Tactical Reconnaissance Group remained under the control of XXIX EAC, and 40th and 401st IB Groups were assigned to it. With four fighter-bomber groups and one tactical reconnaissance group under its operational direction, XXIX EAC began its active cooperation with the Ninth U. S. Army.¹

Distribution of Fighter-Bomber among the Tactical Air Commands

As a result of these and other readjustments the assignment of fighter-bomber groups among the three tactical air commands of the Ninth Air Force on 31 October 1944 was as follows:²

<u>IX EAC</u> (First U. S. Army)	<u>XIX EAC</u> (Third U. S. Army)	<u>XXIX EAC</u> (Ninth U. S. Army)
335th IB Group	351st IB Group	366th IB Group
336th IB Group	353rd IB Group	400th IB Group
337th IB Group	3021 IB Group	373d IB Group
338th IB Group	408th IB Group	401st IB Group
370th IB Group	409th IB Group	
474th IB Group		

Operations in October

IX Tactical Air Command

Air-Ground Cooperation

As would be anticipated, IX EAC acted jointly with FUSC in October. Direct air-ground cooperation was particularly in evidence from the

ed through the 21st when eastward advances to the north and south of
 Lashen by VII and XIX Corps isolated the city and forced its surrender.
 On the 13 days of this 30-day period when weather allowed general
 operations by the command, at least half of each day's missions was
 assigned this significant role. The fact that some were styled
 'Support' and others 'Armed Reconnaissance' matters little. In default
 of targets assigned by the Air Support Party a so-called 'Support'
 mission could perform armed reconnaissance ahead of the advancing
 ground column. On the other hand, armed reconnaissance missions were
 frequently asked to deliver air strikes by ground controls of various
 types. The concentration of the resources of IX MIG upon this essential
 mission was particularly evident on 2 October when 17 out of 33 missions
 flown were in air-ground cooperation, on the 15th when the ratio was
 20:33, and on the 16th when it was 19:31. As a rule the missions were
 in squadron strength (12 aircraft), although on occasion entire groups
 participated. After Lashen's surrender on the 21st the resources of
 IX MIG were increasingly devoted to the task of rail interdiction.

In general these air-ground cooperation missions were unoppositional
 but important, and displayed the same general characteristics as those
 of the earlier period. Hence only exceptional examples need be re-
 hauled here. In association with XIX Corps' efforts north of Lashen on
 2 October, 370th TB Group bombed eight of the 10 pin-pointed positions
 assigned to it, while 474th TB Group hit four others marked by ambush,
 with results reported excellent by ground. Gun positions associated

with a counterattack by enemy armor in the same area were hit by two squadrons of 49th AB Group on the 5th. Enemy armor, gathering for counterattacks on 1st Infantry Division, was struck by one squadron of 388th AB Group on the 13th in what ground described as a "gorgeous job," and a second squadron bombed another concentration in the same area with results unobserved. On the 15th, as American troops closed in on Aachen, defense positions near or in the city were destroyed by five missions, four of group and one of squadron strength.

As 7 Corps attacked south of Hürtgen Forest on 14 October, 32 P-47's of 388th AB Group attacked the town of Uckerath on request. Artillery cooperated by counter battery fire on flat positions and by turning the target with smoke at both ends and in the middle. In consequence the fighter-bombers had a clear run and destroyed or damaged nearly every building in the town. As a result of this and other actions, Maj. Gen. Edward H. Tamm, Commanding General of 7 Corps, commended IX MAS for "particularly fine close support that was of the greatest assistance in repelling vicious German counterattacks. This support alone has accounted for an appreciable number of enemy personnel and vehicles, including tanks and artillery."⁶

On 15 October, 49th AB Group flew a total of nine squadron-strength missions in association with XIX Corps. Favorable comments were elicited from ground forces after four attacks on towns, gun positions, and entrenched troops. One squadron had already delivered one successful attack when it was called upon to strike a concentration of some 30 tanks. It had only two tanks left, but it dropped these on the enemy

order and then flew over the front at 50 feet, strafing the German troops as they attacked. The ground report declared that those who were not killed or wounded turned and fled. Because of its importance this mission was commended by USIA. It is evidenced by such spectacular missions, and by many others well executed, IX TAC was running true to form in executing its task of air-ground cooperation.

Actions against the GAF

IX TAC likewise maintained its tradition by operations against the GAF with October claims of 32-12-25 in the air and 24-9-6 on the ground. Aside from such actions as that on 2 October when an element of 305th TD Group forced a jet-propelled MiG-19 to crash, this achievement was largely the result of actions on five days. On 4 October a squadron of 401st TD Group was attacked by an equal number of enemy aircraft with results of 5-0-1, while 32 F-84's of 367th TD Group bounced 10 MiG-19's and damaged three.

Two days later 305th TD Group scored a notable success. While on a sweep east of Aachen the group was vectored to the enemy airfield at Emmerich AB, where F-Intercept had learned that gliders which had been over our lines were landing. Fifty MiG-19's were strafed on the field with claims of 23-0-3, and two others were destroyed as they came in to land. Four groups shared the honor on 12 October. Vectored to 40 enemy aircraft northwest of Aachen, 305th Group destroyed four for no loss. Eight planes of 367th Group were jumped by 23 MiG-19's and claimed 3-0-1 for the loss of two; while a squadron of 305th Group, joining in an action already underway, lost one but claimed 2-1-1 in combat with

20 enemy aircraft. Ten planes from 47th Group joined in the fight over Luban and reported 7-1-1 without loss.

On 13 October 23 aircraft of 47th Group were vectored to 20 enemy planes in the Durn area and in the ensuing encounter claimed 7-1-3 for the loss of three, while two planes on the way home bounced 16 ME-109's and claimed one. Nine F-47's of 363th Group lost three in an encounter the same day with 10 ME-109's, claiming 1-0-1. Three groups shared the honors on the 20th when a total of 133 GAF planes was sighted. Three squadrons of 367th Group on a rail-cutting mission had three separate engagements with enemy formations of 20, 16, and 7 planes, respectively, over Bruhl and Durn. Seven F-49's were lost, but the total claim was 8-2-13. Also on the 20th, 20 of the escort bounced 32 F-39's of 370th FG Group in the Durn area, and 20 others encountered 11 F-47's of 363th Group near Töblenz. In the first encounter claims were 2-1-3 for the loss of two; in the second two were lost against claims of 6-1-3.

In the Töblenz area conspicuous success was achieved by 20 F-47's of the 363th Group in an afternoon group on the 21st. They first bounced 25 to 30 enemy aircraft, and then as their fuel was running low, attacked another formation of equal size. Their total claims were 22-3-11 for the loss of three.

Recapitulation

In the course of the month of October IX FMS flew a total of 205 missions with 6,321 fighter-bombers dispatched--approximately one-third

less than in the preceding month. A total of 1,667 tons of ice, including 139 blanket bales and 133 burlap, was dropped. Since the number of sorties fell off, and the use of the front was generally stabilized, ground of ice dropped considerably as the following list shows:⁷

ICE	78	Enemy interdicted	7
Airport vehicles	16	Bridges	8
Motor-driven vehicles	1	Bungalows	1
Locomotives	106	Gun positions	21
Railway cars	117	Irregular concentrations	41) successfully
Rail cuts	217	War balling yards	23) attacked

Air Tactical Air Command

Air-Ground Cooperation

Air-ground cooperation on the part of XIX TAC was evident on a limited scale in October. The Third U. S. Army, with which it operated, was comparatively quiet, its major actions centering about the forts guarding Hita and in an outward advance from Fort de Mearson and Fincer which resulted in crossings of the Seule River west of Chaumont Salins. In both these areas XIX TAC was active.

On 3 October 24 planes of 353rd IB Group struck at three Hita forts with results on the reported good by ground; while 405th IB Group, cooperating with XX Corps in its attack on Fort Briant, flew nine squadron-strength missions against Hita targets with good concentrations reported on one. Plans were seen moving into the fort at U-7854 after a squadron of 353rd Group attacked on the 6th, and the next day a squadron of 3301 IB Group struck at those to the east of the city. On the 11th a troublesome railway gun southeast of Hita was brought out by a squadron of 353rd IB Group which destroyed camouflaged installations on railway tracks; while on the 14th gun positions at St. Remy were attacked by a

formation of 404th IB Group. Such actions as these stand out among those reported in the Metz area.

Others were similarly evident in connection with the movement toward Chateau Saline. On 2 October 405th Group bombed tankic west of Lisieux with unobserved results and thoroughly strafed the towns of Mallavecourt sur Villis, Jallucourt, and Fresnes en Chalnois. On the 7th 31 aircraft from the same group hit troop concentrations in woods east of Pont a Mousson. A similar concentration southeast of Chateau Saline was bombed and strafed by a squadron of the 302d on 12 October, and a command post destroyed. On the 13th one of the squadrons of 305th Group hit an area with tank traps near Lezoucourt, and on the 13th, 16 aircraft of 302d Group bombed a tank concentration at Vico, east of the Fort de Ferry. A unit plan in the area reported that the bombing was very accurate.

Attacks in air-ground cooperation were occasionally directed to other areas. On 5 October a squadron from 408th IB Group was sent to work with 79th Infantry Division (Clark U. S. Army), and destroyed three enemy batteries east of Blument. To the west of Luxembourg, on the IVUSL front, the towns on the Moselle were hit by a formation from 302d IB Group on the 6th. A week later (12 October) a squadron of 302d Group joined in 302d's attack on Aachen, where it discharged 10 rockets at a formation of 30 tanks, destroying three and damaging six more.

An anti-air attack was delivered by elements of 302d IB Group on 20 October. In the morning the squadron dived through intense flak to

bomb an earth and masonry dam at Hiep with 1,000-pound C-4 bombs,
 10 of which hit the dam. A third squadron on an afternoon mission found
 that the earlier attack had cut a channel through the dam, and added to
 the damage by four additional hits. The purpose of the attack was to
 leave the impounded waters of the Hiep de Hiep before American troops
 crossed the S'ville in this area, so that the Communists might not have an
 opportunity to cut them off by blowing the dam after their projected
 crossing. Plans had been fully coordinated with III Corps, whose
 mission was to deliver a limited objective attack in the area. Their
 execution was as successful as to bog down Communist tanks, reduce the
 mobility of many enemy elements, and disrupt the Communist scheme of
 maneuver. As a further result of this air operation the American
 attack was successfully completed three days later.³

Air Action against the CMF

Air combat was comparatively infrequent in October. After three
 squadrons of 408th Group had hit the assembling point at Hiep on
 the 6th their cover flight was jumped by 20 Mi-109's. Other American
 aircraft joined in the encounter in which they lost one plane and
 claimed 4-0-1. Two days later a squadron of the same group caught
 four enemy aircraft in a traffic pattern over the Hiep airfield,
 destroyed them all, and claimed 1-0-3 on the ground. On 2 October
 elements of 308th IB Group sighted three enemy formations, but only
 one encounter resulted when three enemy aircraft which attacked a
 squadron over Chien Chien were accounted for in the week, at 2-0-1.

The out-tanking action of the month was that in which 355th FG Group participated in the Beckingen area on the 29th. Thirty-five B-31's were then bounced by 75 ME-109's which had a 50-plane top cover that eventually joined in the 75-minute contact. American pilots reported that the enemy pilots were the best aggressive they had ever encountered, and that they maintained their formations in flight of four. In spite of this the group claimed 24-2-3 for a loss of three. When a squadron of 355th Group attacked the airfield at Cochem-Kall on the 8th the ground claims were 3-0-5. During the month XIX TAC's claims against enemy aircraft amounted to 44-2-16 in the air and 23-10-16 on the ground.

Recapitulation

During October XIX TAC lost two groups. In addition, weather prevented operations on seven days and limited them on 12 others. These facts in combination reduced the command's effort to a total of 4,730 sorties. Among ground claims was the destruction of 317 MI, 300 armored vehicles, 387 locomotives, and 1,303 railway cars.

XIX Tactical Air Command

Air-Ground Cooperation

Since the Fifth U. S. Army was holding a quiet and stable front during the better part of October, air-ground cooperation on the part of XIX TAC was conspicuous by its absence, and the command was free to devote its resources to other tasks. However, its units report

some actions in association with VIII's drive against Aachen when 366th IB Group flew three squadron-strength missions of the usual sort on the 12th. On that same day 373d IB Group sent two group-strength missions for joint action with the ground forces in the Aachen area. The first did what ground described as a "good job" on one tank concentration north of the city, and proceeded to attack the others near Eckweiler. The second also struck at tanks and likewise barbed buildings held by enemy troops. Later, after its associated army had moved to the north, 48th IB Group flew three squadron-strength missions on 23 October in association with XIX Corps. In the course of these missions the well-known town of Liesborn was bombed with results unobserved, but other attacks on inhabited localities were held up because the enemy was throwing white and colored smoke shells within friendly lines.

ACTIONS AGAINST THE GAF

Only infrequently was action possible against the GAF in October. The 373d Group, however, had one of its squadrons bounced by 50-plus enemy planes over Koblenz on 7 October. It suffered the loss of two aircraft, but its claims were 11-1-0. The only other considerable air contact during the month occurred on the 25th. Then 16 aircraft of 301st Group, waiting for a rendezvous with bombers over Andernach, were attacked by 30-plus of the GAF. In the ensuing action American planes claimed 5-0-1 for no loss. In actions on 2 October enemy planes were destroyed on the ground. On that day 366th Group sent one group

mission against the airfield at Gross Osthelm and another to that at Oker Old. In both cases damage was done to installations, and at Oker Old four enemy aircraft were destroyed on the field. The same day 23 planes of 373d Group attacked an airfield southeast of Frankfurt with claims of 8-0-9 on the ground.

9th Bomber Division

Air-Ground Cooperation

Air from its attacks on transportation targets in October, 9th Bomber Division occasionally flew missions which are to be classified as air-ground cooperation. On 8 October a group bombed Dredens on the south shore of the Scheldt estuary. Ground had requested the action which was designed to assist in Dredens' capture by the British, and the target area was well hit.

Earlier, on the 2d, in coordination with the XIX Corps' push north of Aachen, attacks were delivered against defended villages. Three missions bombed areas at Herbach in attacks by one, two, and three groups. Only part of one mission hit the assigned area. On the same day the missions were given Utsch as their target. The first, of three-group strength, bombed in great error; while the second, of single-group strength, placed the bulk of the flight in the target area. Linnich, through which reinforcements moved to Utsch, was struck on 8 October by a single group, two of whose flights damaged buildings, roads, and a bridge. On the 12th and 13th, respectively, an obstacle in the path of the 9th Infantry Division, was bombed in group strength.

attacks. No damage was done by the first, but the second caused direct hits on rail lines running through the town.

In the Hatz area 8th Bombardment Division struck at two bases south of the city in an effort to neutralize guns which were holding up the advance of the 5th Infantry Division into Fort Erlant. Thirty-four B-24's attacked, dropping 66 tons of bombs, and reporting probable heavy damage to one target and slight damage to the other.¹⁰

Operations in December

IX Tactical Air Command

Air-Ground Cooperation--Operation QUEEN

During November weather limited all operations on the part of IX TAC. On nine days no combat operations were possible, on six others fewer than 100 sorties were flown, and on only four were more than 300 negotiated. Moreover, on many days when operations were conducted weather reduced their efficiency to a marked degree. In spite of such considerable limitations, a fitting proportion of IX TAC's effort was devoted to air-ground cooperation in operations which centered about Aachen. Since the character of such actions has been fully detailed in the narrative of earlier periods, only a summary treatment is required in that for the month of November.

Between 7 and 9 November from 10 to 33 per cent of available air effort was planned to be used in the Schmidt area southeast of Aachen where 20th Infantry Division (V Corps) was seeking to advance through the wooded defiles of the Hurtgen and Gemund forests. Squadron-

strength missions were regularly flown--two on 3 and 4 November, three on the 7th, four on the 5th and 6th, and five on the 8th. In addition, as circumstances demanded and as weather permitted, missions of greater weight and more special tasks. Squadrons, cooperating directly with Air Support Parties, struck at flat positions, barracks, and concentrations of troops and armor. They likewise hit at the defended towns in the region at ground's request--Schilt itself and so attached, together with the neighboring towns of Vöcklabruck, Föhrlburg, and Orgstein. The 305th was usually employed to mark the targets which ground units were attacking, although the Army sometimes sought to confuse the situation by firing red smoke shells into the areas hit by American troops. Special missions of approximately group strength were dispatched into this area on some six occasions in this limited period. The 304th Airborne of 47th AB Group bombed the town of Schilt on 5 November, and on the 6th another 304th group dropped their bombs in a wide-area reported to contain concentrations of armor and troops. The same day the 305th flew a group-strength mission which made armor vehicles its target. Flare bombs dropped by 370th Group on 7 November fell on well-emplaced gun positions near Euzen and, according to ground report, covered the area. On the 8th, 47th Group struck at the town of Schilt, at gun positions in the vicinity, and at the town of Eufelschall. Elliot's report suggests that the bulk of the individual missions in the Schilt area achieved the measure of success. The commendation received by

IX SAC from the Commanding General, 7 Corps indicated that the net result of air's contribution to operations in the area was the approval of the ground forces.¹³

Operation QUEEN was the code name applied to the joint air-ground effort which had an advance from the east of Anson towards the rear and the Rhine as its general objective. Bad weather had forced the postponement of the assault from day to day between 11 and 15 November, but on the 16th it was launched. Even then weather limited air operations.

On each of the 10 operational days from 16 to 25 November IX SAC flew air-ground cooperation missions. Ordinarily these were of squadron strength, and their actual number per day ranged from a low of six to a high of 18, the number being largely dependent upon the weather. On 23 November, 18 out of 23 daylight missions were directly coordinated with the ground effort.

On 16 November three missions of unusual interest took off to bomb by daylight targets just prior to the launching of the ground assault. Targets for planes were assigned to 307th Group, as many were by the 47th, and 15 by the 307th. The 307th Group hit its three targets in the vicinity of Herten. They had been marked by smoke, and ground signal 1 that the targets on 11 were now on 13-14. The 47th, whose three targets lay southeast of Herten, struck two of them, and also a third which had been marked by smoke to the north of that originally designated. The original name of this target was the designated objective for the 307th. This group had difficulty with

overcast and dropped 21 of its bombs out into the specified area. However, a good concentration was dropped on one design and target and a few bombs fell on another. The four medium-weight missions flown on the 18th in cooperation with infantry divisions resulted in destroying rail, rolling stock and buildings, the towns of Julich and Coy, together with gun positions at Heisterm.

In the days which followed (17 to 20 November) IX US concentrated its effort in the battle area. Its operations struck at the usual tactical targets. Ground was placed with the attack by 325th ID Group on gun positions and houses containing troops near Eistenmuth (18 November), on the same day with 303rd's attack which forced first units out of hiding at Heisterm. The bombing of a command post and house and the striking of railroads near Heisterm by elements of 303rd Group on the 20th were reported as excellent. When an enemy counter attack was preparing on the 20th in the Eistenmuth area, 303rd ID Group struck at a train, its engine, a school, and at headquarters from which it was. The next day ground declared that the results of the 303rd Group's striking of gun positions, on a troop concentration, and at a debussing point in the Heisterm area were excellent. It also by the 303rd at an old camp near Coy (27 November) and gave the same high rating.

As a result, the reports of the period indicate that towns and villages were the characteristic targets given to, or selected by, missions or air-ground cooperation. The enemy had, in the period following the stabilization of the front in September, turned these into fortified

positions and they had them to be reduced, one after the other, by air and ground attacks. More than 35 different targets of this type were hit in this period, most of them by repeated attacks. For the most part they were situated in the area bounded by the River Rhine on the west and the Ticht and the Inle to the east, with notable concentrations on either side of the main road between Eickweiler and Duron in the north, and in the wooded area about Wurtgen in the south. Pilots' reports, supplemented in some cases by observation on the part of ground controls, indicate that such attacks were usually successful. In 1 case reported to have fallen on a truck-mounted crane, producing fires and in some cases explosions. No greater detail could be expected from the observations during action, and while the statements lack detail, they confirm the impression that the expert aerial pilots of III TAC did much to further TUI's advance to win the zone by their repeated strikes against enemy-held towns and villages in the battle area.

In this case, such successful attacks, coordinated with ground operations, were made on 25 June in the area of Duron and west of Weln or Eickweiler. The importance of such targets was based on the shortage of enemy reserves and supplies. On the 23rd the 30th Troop, one from 300th and the other from 305th AB Group, were assigned to air-ground cooperation but was assigned to the vicinity of Hattinchen to train which was loaded with enemy armor. With in sight of 30th's squadron destroyed eight armored vehicles and produced a large explosion; 30th from the 300th also the destruction of 10 to 12 Tiger tanks with damage to an enemy camp. The train had been lost

by the 37th Tactical Fighter Group, and control was maintained throughout the attack.

Operations against the SAM

Claims by US F-4s against enemy aircraft for November were roughly equal to those of the previous month. On the ground 1-0-3 were claimed, and 77-0-17 in the air. Four encounters accounted for the greater part of those destroyed in aerial combat. On 19 November one squadron of 307th Group was attacked by 25 SA-100's southeast of Duran; a record of the ground engagement followed in the encounter, and together they claimed 7-3-3 for no loss. On 20 November a squadron of the 300th accumulated 20 enemy planes in the Western area and without loss claimed 1-0-3. Sixteen F-17's of 510th Group were on an escort mission on the 21st, but were restricted by ground control to 30-100-1000 in the vicinity of Enghien. The escort for 10-3-3 at the conclusion of the preceding combat, which included American loss. It was 510th Group's turn on 22 November, and 17 of its planes on a mission with 10th Tactical Fighter Division accounted for a total of 29 enemy aircraft southeast of Duran. Claims were 1-0-3 for no loss. It is of interest that 100th Night Fighter Squadron obtained the destruction of a rebel base and a score of 2-1-1 against enemy planes following a mission by 11 F-11's on the night of 23-27 November.¹⁰

Recapitulation

In all of 1970 operations in November, US F-4s flew 177 missions, and patching 5,100 planes of which 5,015 were destroyed. Its losses

were 45 aircraft and 39 pilots. Among its more significant claims in respect to ground targets were those relating to the destruction of armor and transport: 37 armored vehicles, 131 AFV, 17 horse-drawn vehicles, 43 locomotives, and 128 rail cars.¹³

IXX Tactical Air Command

Air-Ground Cooperation--the Metz Area

On 8 November XIX, which had been waiting for weather favorable to air operations since the 5th, jumped off with the XII Corps southeast of Metz. On the following day the XII Corps joined in the assault in the Metz area, and the advance was continued through the remainder of the month. Plans for the use of other Ninth Air Force units in the initial operations were blocked by weather; but on 14 operational days from 8 to 30 November XIX TAC played its characteristic role in air-ground cooperation, flying an average of 10 missions of this type each day when weather was singularly propitious, and accomplishing more than it was able to do on the less favorable days.

On 8 November a first effort by 3691 TB Group against enemy command posts at Doulay and St. Avold was uncertain as to the results produced by its bombs and rockets, but a second mission against the same targets destroyed buildings and started fires. In the same day operations from the other groups made command posts their objective. Element of the 405th hit those at Poltra and Breconcourt with excellent results, and a squadron of the 106th destroyed that near Harville Les Vics. The strike at Poltra was delivered by a single squadron--12 aircraft

carrying to the with four others offering top cover. They hit the target with 500 CP's, using drop-bombing techniques, and obliterated five buildings destroyed and seven others damaged. This attack disabled the 1st Battalion of the 17th SS Panzer Grenadier Division which served as mobile reserve in the Metz sector; and the destruction of its command post, together with its records, disorganized its operation for an appreciable period. ¹⁴ Cooperating with the 209th and the 255th Infantry Divisions in the Metz area, the command elements of 350th Group dropped Napalm and 500-pound CP's on gun positions and trenches, hit tanks with frags, and obliterated the destruction of two tanks and one artillery piece. The 105th Group's two squadron-strength division hit the Forest de Chateau Saline, dropped Napalm on trenches near Liecourt, and struck at woods near Metz.

Characteristic targets for air cooperation with ground troops and reports in later reports. Three formations of 350th Group destroyed 15 horse-drawn vehicles, four tanks, and one piece of artillery and damaged eight tanks on the 9th, one squadron of the 3601 hit gun positions near Neerigumacker. The following day a squadron from the 405th ~~regiment~~ ^{regiment} tank unit targeted by the Air Support Party. A 100-foot column presented their discovery, but ~~to~~ ^{to} containing ~~only~~ ^{only} troops was hit with results declared good by ground.

As American troops pushed deeper into the enemy's line 350th Group dispatched 11 sorties which destroyed 34 pieces of horse-drawn artillery and 23 tanks near Luxembourg (11 destroyed), bombed gun positions

... of ... through the overcast (10 November), and destroyed four guns in ... with 10 direct hits (10 November). ... group ... (10 November). ... (10 November).

... constituted the main target for ... particularly on the latter of ... of the ... They were noted as of such importance that in the case of ... (10 November) and ... (21 November)--an effort ... to hit them by ... under ... control through the prevailing overcast. The towns attacked were scattered throughout the assault area--Muzmont, Borny, Bizange, ... and ... being typical. ... will serve to ... occasionally ... in the ... of this effort. ... on the ... day and seven on the second, with from six to eight ... participating in each. Their objectives were ... in a small area ... the Luxembourg frontier and ... five of which were hit on the ... and other were on the ... day. In these attacks on ... in coordination with ... and ... or ... of ... of ... by the use of 500-pound ... Successive ... (to ... building ...), ... (to ...), and ... (to ...). The ... in that order.¹⁵

In ... the ... directly ... in ... directly ... to the ... of ... The successive attacks

On November, three P-51 Mustangs of the 354th Fighter Group destroyed 10 aircraft of the 354th Fighter Group and 2 Mustangs. Claims for 11-1-43 for the loss of three. Three days later, a squadron from the same group destroyed two of the P-51 Mustangs which attacked over Trier. On the 17th, a flight element of the 354th was engaged by 10 enemy aircraft at Trier. One plane was lost, but the destruction of the enemy aircraft was claimed. The formations of the 354th Group had encounters with the Luftwaffe over Strasbourg on 22 November and claimed a total of 3-0-7 for the loss of one. The following day the squadron of the 354th Group admitted claims of 3-0-3 for the loss of one in aerial combat with enemy formations. Total claims for the month against enemy aircraft were 32-0-6 in the air and 10-1-13 on the ground.

Recognition

Throughout November the weather had been favorable, with only 11 good flying days and with 17 completely non-operational; but a total of 3,500 sorties were flown by the 354th and 913 tons of bombs were dropped. Among its claims against ground targets 31 buildings were reported destroyed; 917 cars, 72 armored vehicles, 115 horse-drawn vehicles, 375 locomotives, 337 rail cars, 100 gun emplacements.

354th Fighter Group

Air-Ground Cooperation--Operation JUBILEE

The ability of the 354th to participate effectively in air-ground cooperation is clearly demonstrated in actions related to Operation JUBILEE. This began on 10 November and involved an airfield located by the Fifth Army on 11 Nov by the First U. S. Army. For the duration

experience of staff and of combat units alike was such in evidence on the narrow front of the day with which XIII SAS was associated. A further contribution to success was the fact that in the course of the preceding week pilots had had an opportunity to become thoroughly familiar with the terrain over which they were now called upon to operate intensively in very close cooperation with the ground forces, which reached the coast by the end of the month.

In general air-ground cooperation followed a new familiar pattern, with air support staff directing the actions of ground forces over the immediate front and with headquarters flying on missions at High U. S. Altitude (HUA). In the matter of technique it is interesting to observe that XIII SAS on occasion reverted to the practice in vogue at the outset of the invasion of providing forward column cover by means of relays of formations of four aircraft each. This type of action was particularly conspicuous on 19 November when 40th CB Group flew off such missions in the course of the day, and on the 19th and 20th when 40th CB Group flew 25 and 23, respectively. Squadrons and groups were, however, often employed on air strikes, as well as on tactical reconnaissance and planned missions.

Finally, the story of air-ground cooperation is full of many small incidents, and in most cases incidents of great detail will be dealt not go beyond the simple facts recorded in pilot reports, which record the basic facts of a mission. It is noted from the air war (for example, the 20 November reports of a series of missions by squadrons of 40th Group and by a single group formation of the 40th, merely

records give all of the tanks, or on areas where they were believed to be concentrated in the vicinity of Bessheim. The destruction of these tanks was claimed, and in the same report ground troops told air that its bombs were on the target. These rather barren reports were later supplemented by evidence from the ground forces, which indicated that these air strikes had materially assisted in breaking up at least the outer line of enemy counterattacks and that, on several occasions, the very presence of our air strikes over an area caused the enemy's fire to cease. At least a ground air strike within 400 yards of friendly troops, or the air action, both prompt and effective, allowed ground movements with the capture of the town.¹⁷ Such added information is the basis of the claim that such action is unusual. It is again available, in general terms, in the shape of a letter from Lt. Gen. W. H. Simpson, Commanding General of Ninth U. S. Army, who commanded XVIII ABZ for the "Excellent air support on 16 November" which "contributed materially to the initial success of the ground troops."¹⁸ Such praise was the more not to be because weather had restricted operations to 100 sorties on 16 November and had curtailed the carefully planned operations which had been scheduled for that day.

Weather was destined to limit operations from 16 to 21 November. There were no exceptions 1 day (19, 20 November) when over 400 sorties were possible. On the other hand, there were three days (17, 20, 27 November) when only 1 or less than 100, and three more (18 to 21 November) when there were none at all.

In spite of such difficulties the sort of air-ground cooperation

aircraft formation. Bombers and other aircraft were destroyed or damaged, but there were no claims against aircraft on the ground.

In a month over 12 days of air operations on the part of VIII A.C. a total of 1,963 aircraft had been dispatched, of which 1,501 were successful sorties. Eighteen aircraft were lost. More than 1,100 tons of C-47 bombs and over 22,000 gallons of fuel were dropped. Among the more significant of the month's claims were 12 tanks, 31 cars, 25 locomotives, 197 railway cars, and two rail and three pontoon bridges, together with 28 rail cuts.¹²

9th Bomber Division

Air-Ground Cooperation

The Aachen area. In marked contrast to its operations in the previous month, 9th Bomber Division frequently cooperated directly with the ground forces in November. With the exception of a four-group attack on a strong point near Herbin (19 November), all of the 28 attacks in direct air-ground cooperation were related to the assaults of the First and Ninth U. S. Armies from positions east of Aachen towards the Saar River and the open plain east of Töln. The area was thickly settled with towns and small villages which the enemy, deprived of his positions in the Siegfried Line, had developed into centers of resistance. The attacks delivered on the 10th, when TUSA jumped off, and those carried out in coordination with the Fifth Army Group. These following that date had their origin in requests submitted by G-3 Air of the Fifth Army Group.

Of the 24 aircraft delivered in the area of location 16 accomplished their purpose with reasonable certainty, although the findings were irregularly reported. A limited air transport priority to the assault, and positions of the 1st and 2nd Divisions, the 1st and 2nd Divisions, respectively, and others at Fort Belvoir by the groups on the 10th. Such findings were primarily the result of the 1st and 2nd Divisions Group that aerial bombardment of the assault area should be carried on to the maximum extent. This desire originated in their lack of ability to maintain on the ground, and on the other, in the possibility that weather might force the carrier to abort without the planned air bombardment accompanying their assault. The desire had been strongly expressed as early as 22 October, and on 12 November the 1st Army Group gave such bombardment top priority. Weather, however, limited the operations of 9th and 10th Air Divisions from 12 to 15 November.

Operation JUNE. Operation JUNE was scheduled to accompany the launching of the ground attack on 12 November 1944, to be coordinated by the Commanding General, 1st Air Force. In it the major role was assigned to the 1st Air Force and 1st Air Division, which were to make use of all available aircraft in the 1st Air Force and 1st Air Division. Such aircraft were to be used by aircraft of 9th and 10th Air Divisions, which were given the highest priority. The 1st Air Force and 1st Air Division were to be given the highest priority through the 1st Air Force and 1st Air Division. The 1st Air Force and 1st Air Division were to be given the highest priority through the 1st Air Force and 1st Air Division.

essentially alike in weather conditions. Visibility at the time was
 so limited that it forced the cancellation of the missions by five
 of the eight groups scheduled to participate in the third bombing
 plan which had been adopted. Only one of the two groups assigned to
 Echts bombed its target, but 15 aircraft of the second group struck
 near-by. Incheon, to which one group had been assigned, was hit
 by the majority of the fourth group. The pathfinders had led each
 of the attacking groups. Four pathfinders bombed with four tons of
 500-pound bombs, while the 76 B-29's which attacked dropped 149,400 tons
 of 200-pound bombs.

Three missions dispatched on the 17th were unable to reach their
 targets; but on the next day four defended areas were well hit,
 Miramiller and Pusan by two groups each and Echts and U by single
 group attacks. On the 18th group-strength missions produced satis-
 factory results at Miramiller, Pusan, Seishan, and Gamsan. Attacks
 in group strength on Pusan, Echts, and Seishan were on 21 November
 were attended by excellent or excellent results. In the 23rd, Korea, P
 Dingshan was hit by one group and Miramiller by two, with no other ex-
 cellent or to gain the commendation of General Collins, Commanding
 General, VII Corp. 21

On 22 November the results of the bombing of Miramiller by one
 group were excellent. At Echts little damage resulted from an
 attack by 10 aircraft, while the two groups which bombed Pusan did
 considerable damage. All of the attacks were led by pathfinders.
 The following day (23 November) localities in the rear of the battle

area, a patrol to contain the reserves of four CS FZ divisions, to be
detached. Withdrawals will hit by one group, another inflicted
some damage at Stochol, and another were produced in and west of
by the CS groups which attacked there. Again, pathfinders led 11
three divisions.

Cooperation with the Third U. S. Army. The Third U. S. Army had re-
quested the attack on strong points at Hwang on 19 November, as its
northern flank moved to cross the Sui River. Two groups were assigned
to one area, and one each to the others. Ninth Air Force of course
reported that the bombing by CS aircrft was excellent and accurate.
The next day General Sutton, Commanding General, AFSA, congratulated
9th East Airmobile Division on the results achieved and declared that
"The willingness of your aircrews to go in against heavily defended
targets is an inspiration to this Army." (2)

Still cooperating with the ground forces but reaching behind the
battle zone, 9th East Airmobile Division brought considerable variety
of supply depots in an effort to reduce his immediate tactical re-
sources of men, ammunition, oil, and other vehicles, and supplies in general.
Nearly 2500 tons of such supplies were made in the course of the month,
with a notable concentration in its closing week. On 17 and 18 Nov 1961,
The depots at Stochol (22 Nov 1961), Hwang (22 Nov 1961), and Hwang
(22 Nov 1961) lay to the west of H. Thien; all others were produced
to the Hwang area.

Of these missions 15 were 18 to 20 or less, and 12 were 21 or more
with a maximum of 24, and only 1 mission will be to 24 or more.

At 1700 (4 November) 50 aircraft attacked and severely damaged airframe
 supplies in warehouses and in the open. Holdings were hit on the 50th
 by 150 planes which destroyed 1 or 2 and 1 supply warehouse filled with
 ammunition, and another destroyed by 50 aircraft on the 20th. The 50th
 buildings and air storage area. Damage to 20th was done by
 three groups on 9 November at the special request of HQ, which pro-
 vided a group of 100 planes, and buildings in the target area suffered
 severe damage. Only 50 aircraft of the group, at night, destroyed
 (destroyed) on the 10th destroyed this target, but did so with re-
 sults that were not satisfactory. Then at the request of the 50th
 W. G. group, 50 aircraft attacked the target at night at England
 on 17 November, and then 70 planes of the 50th destroyed this target
 houses and rail yard.

An expedition Group of 100 aircraft of the 50th group
 attacked on the 10th and the flight produced satisfactory results by
 placing their bombs in the area. Half of the storage depot at 20th
 was destroyed on the following day by a group of 100 aircraft
 with a view to limiting the supplies of the enemy in the area. With the
 assistance of 100th and 100th and artillery units, the
 50th group, the night's south was destroyed. On the 20th the group
 bombed with pathfinders and destroyed some buildings and damaged other
 others. The most buildings were destroyed by a single group of 100
 on 20 November. Again with a view to preventing the enemy from stage-
 ing the American advance at the Siegfried Line, the storage area at
 Bergsch was destroyed on the 20th. Only 10 aircraft of the

G L O S S A R Y

ADGB Air Defense of Great Britain
ADLS Air Dispatch Letter Service
AEAF Allied Expeditionary Air Force
ALG advanced landing ground

FUSA First U. S. Army

MT motor transport

Gpreps operations reports
ORS Operational Research Section, Ninth Air Force

FFF pathfinder

R/T radio telephone

SCU Statistical Control Unit
SHAEF Supreme Headquarters, Allied Expeditionary Forces

TRS Tactical Research Section, Ninth Air Force
TUSA Third U. S. Army

USSTAF U. S. Strategic Air Force

VHF very high frequency

NOTES

Chapter I

1. AAF Historical Studies: No. 32, Ninth Air Force in the ETO, 16 October 1943 to 16 April 1944.
2. Memo, n.d., History of DC/S, Plans; IC/S, Plans, Notes on Planning Operation "Neptune," 16 Oct. 44; ltr., Signal Communications Officer, 9th AF, Signal Planning for Operation "Neptune," 18 June 44.
3. Memo by Signal Communications Officer, 9th AF, Signal Communications in Operation OVERLORD, draft, n.d.

Chapter II

1. Report of Supreme Commander AEF to Combined Chiefs of Staff, 31 Aug. 44.
2. Unless otherwise specified information for this and for all later accounts of operational activities is derived from materials which are for convenience described as "9th AF Operational Records." These exist in a variety of forms, but reference to all of them is effected by use of the dates and/or the units involved. For a description of these operational records see the bibliographical note.
3. Eq. 9th AF A-2 report, Marshalling Yard Targets 1 March 44 to D-Day, n.d.; Bombing Analysis Unit, SHAEF Main Air, Report No. 1, The Effects of the Overlord Air Plan to Disrupt Enemy Rail Communications, 4 Nov. 44.
4. 9th Bomb. Div. CRS Report No. 77, 7 Dec. 44, in 9th Bomb. Div. history, Nov.-Dec. 44.
5. Hq. 9th AF Reconnaissance Report, 15 May-5 June 44, n.d.
6. See map, Tactical Disposition 9th AF, 6 June 44, in Ninth Air Force Invasion Activities.
7. Memo by Lt. Col. R. H. George, Direct Air Support, 29 June 44; memo by Maj. F. C. Angell, Air Support Indoctrination Courses, 25 Feb. 44; Representative, Eq. 21st Army Group at Adv. Eq. AEF, Operation "Overlord" Instruction to ALO's; 9th AF Historian's notes.

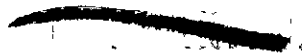

Chapter III

1. 25th SSF Summary of Operations, June 44; report by CG IX CG on intrusion operations; report by ground observer on IX CG operations; IX CG history, June 44; Hq. 9th AF special report, Summary of Operations 9th AF, June 44.
2. 25th SSF Summary of Operations, June 44; IX CG history, June 44; IX CG history, June 44; 9th AF Historian's record of air-ground cooperation reports, 8 June 44; Hq. 9th AF special report, Summary of Operations, June 44.
3. A-1 ltr. No. 14, 6 June 44; IX CG Operational Order No. 350, 7 June 44; Comps. 305th, 306th, and 309th Div. Op. No. 1, 7 June 44.
4. IIS Report No. 25.
5. IIS Report No. 26.
6. A-1 ltr., 4 July 44.
7. IIS Report No. 17, 21.
8. IIS Report No. 15.
9. IIS Report Nos. 17, 18, 19, 20; Hq. IX CG, OCS Report No. 40, Basic Information 448th Is. No. 17 July 44 (suggesting document for IX CG history, July-Aug. 44); ltr., CG, 9th AF to CG USMACV, 13 July 44, Requesting of Willing to Grant to 448th Is. No. 17.
10. Memo by Lt. Col. George, Interdiction Program, 11 Aug. 44.
11. IIS Report No. 100.
12. IIS Report No. 95.
13. IIS Report No. 112.
14. IIS Report No. 119.
15. IIS Report, 9 July.
16. IIS Report, 10 July.
17. OCS Report No. 100.
18. Air Diary, 7th Recon Sq., A-1 Historic Section.
19. Interview report in Washington Post, 3 May 44.



- 30. In IAC history, July 44; 70th Str. Sq. history, July 44.
- 31. Data regarding construction were derived from IX Engineer Command report of December 1944. Data regarding operations were derived from 2nd Squadron history of the fighter-bomber group involved.
- 32. HQ IX Eng. C. G. report by Engr. Gen. James E. McCall, Jr., CG, 71st to the Allied Command, 18 Jan 45.
- 33a. IIS Report No. 10.
- 33b. 300th Str. Sq. history, July 44.
- 34. IIS Report, 9 July 44.
- 35. IIS Report No. 44, 45, 46.
- 36. HQ 9th AF, 9th AF Commander in Support of Assault on Cherbourg, CG-50 Summary; IX AF history, July 44; IX AF - 1st IX AF AFM Series, July 44.
- 37. IIS Report No. 6.
- 38. IIS Report No. 5.
- 39. IIS Report No. 70.
- 40. Grid reference was 20 1207/410 1:000,000.
- 41. IIS Report Nos. 177, 178.
- 42. IIS Report No. 181.
- 43. IIS Report No. 17.
- 44. HQ 9th AF staff report, A-3 Section, 22 July 44.
- 45. IIS Report No. 139.

Chapter III

- 1. Engr., CG IX AF Corps to CG IX AF, 20 July 44, in 70th Str. Sq. history, July 44.
- 2. Cprop. 300th Str. Sq., 11 July 44; 9th AF C.G. HQ, CGA, 22 Oct. 44.

31. Ltr., CG 83d Inf. Div. to CG 9th AF, 3 Sep. 44, in 9th Bomb. Div. history, Sep. 44.
32. IX BC history, Aug. 44.
33. 9th AF Operational Order No. 262, in A-3 mission files, 9 Aug. 44.
34. Figures for fighter-bombers are derived from IX TAC and FUSA Daily Summary of Operations, August to September 44, and operations reports of the groups composing XIX TAC; figures for the IX BC are taken from IX BC histories, August to September 1944.
35. Such evidence as is at present available is to be found in TRS Report No. 147 and its supplement and in ORS Memo No. 41, in IX BC history, September 1944.
36. 9th AF Historian's notes.
37. Ibid.

Chapter VI

1. 9th AF G.O. No. 227, 18 Sep. 44.
2. IX TAC history, Sep. 44; IX BC history, Sep. 44; XIX TAC, Tactical Air Operations in Europe.
3. 9th AF Director of Supply, Air Force Logistical Data, 3d ed. May 45.
4. 367th, 404th FB Gps. histories, Sep. 44.
5. 371st FB Gp. Opreps., 4, 9, 12 Sep. 44.
6. IX TAC history, Sep. 44.
7. Hq. 9th AF G.O. No. 218, par. 4, 1 Sep. 44.
8. Eq. 9th AF G.O. No. 225, par. 1, 16 Sep. 44.
9. Memo by Capt. E. E. Geissler, Organization: Connections between the 9th AF, the XII TAC, and the 1st TAF (Prov.), 24 Nov. 44.
10. 368th FB Gp. history, Sep. 44.
11. 404th FB Gp. history, Sep. 44.
12. IX TAC history, Sep. 44.

- 15. Message, 22 NOV 43, 11 Cpt. 41, in 1732 EB Op. History, Sep. 44.
- 16. Mem., Air Support of Base, 21 (Dr 203) Avul. Div., 18 Cpt. 44.
- 17. Ltr., 22 NOV 43, 18 Cpt. 41, in 3723 EB Op. History, Sep. 44; NIS
Ltr. C. p. operations.
- 18. NIS Ltr. C. p. operations.
- 19. 9th Flab. Div. report, A-33 Base & Combat Utility Mission, 2 Oct. 44,
in 9th Flab. Div. History, Sep.-Oct. 44.
- 20. 9th Flab. Div. COM memo No. 13, 25 Oct. 44, 9th Flab. Div. History,
Sep.-Oct. 44.

CHAPTER VII

- 1. Adv. No. 9th AF Operational Order No. 237, 10 Sep. 44; 9th AF Vietnam
notes.
- 2. Adv. No. 9th AF Operational Order No. 236, 12 Sep. 44; 9th AF
Operational Order No. 237, 14 Sep. 44.
- 3. Adv. No. 9th AF Operational Order No. 274, 21 Sep. 44; 9th AF Opera-
tional Order No. 273, 25 Sep. 44.
- 4. Adv. No. 9th AF Sig. Co. S-5804, 21 Sep. 44; S-5870-E, S-5877-E,
22 Sep. 44; S-5872-E, 1 Oct. 44; S-5803-E, S-5807-E, 2 Oct. 44;
Adv. No. 9th AF Operational Order No. 232, 22 Sep. 44.
- 5. Message S-5807-E, Adv. No. 9th AF, 7 Oct. 44; 9th AF Operational
Order No. 230, 7 Oct. 44, in A-3 mission files.
- 6. 9th AF memo, 9 Oct. 44, in A-3 mission files.
- 7. G-7 Air Report, 12 Oct. 44; 9th AF Vietnam notes.
- 8. 9th AF Operational Order No. 232, 12 Oct. 44, in A-3 mission files.
- 9. NIS and NIS Ltr. Daily Summary of Operations, Sep. 44.
- 10. IML, Oct. 44.
- 11. IML, Nov. 44.
- 12. Compa. for NIS Ltr. unit, Sep. 44.
- 13. IML, Oct. 44.

14. Ibid., Nov. 44; XIX TAC November Operations.
15. Cpreps. XXIX TAC units, Oct. 44; XXIX TAC history, Oct. 44.
16. Cpreps. XXIX TAC units, Nov. 44; XXIX TAC history, Nov. 44.
17. 9th Bomb. Div. history, Sep. 44.
18. Ibid., Oct. 44.
19. Ibid., Nov. 44.

Chapter VIII

1. 9th AF Installations (maps), 30 Oct., 10, 20, 30 Nov.; 9th Bomb. Div. history, Oct., Nov. 44; IX TAC history, Oct., Nov. 44; XXIX TAC history, Oct., Nov. 44; 365th, 368th, 474th FB Gps. histories, Oct. 44; 362d FB Gp. history, Nov. 44.
2. Hq. 9th AF G.O. Fo. 222, 13 Sep. 44.
3. Hq. 9th AF G.O. No. 231, 29 Sep. 44; Hq. 9th AF G.O. No. 233, 2 Oct. 44; Hq. XXIX TAC G.O. No. 6, 2 Oct. 44.
4. Hq. 9th AF G.O. No. 251, 25 Oct. 44; XXIX TAC history, Oct. 44.
5. 26th SCU Summary of Operations, Oct., Nov. 44.
6. IX TAC history, Oct. 44.
7. Ibid.
8. 362d FB Gp. history, Oct. 44; IX TAC Nov. operations.
9. Cpreps. XIX TAC units, Oct. 44.
10. 9th Bomb. Div. history, Oct. 44.
11. FUSA and IX TAC Summary of Air Operations, 2-8 Nov. 44; IX TAC history, Nov. 44.
12. FUSA and IX TAC Summary of Air Operations, 1-30 Nov. 44.
13. IX TAC history, Nov. 44.
14. Cprep. 405th FB Gp., 8 Nov. 44; Impact, III (May 45), 9; XIX TAC Nov. operations.

- 15. XIX SAC, 1000 1/2 Ave. C, - 1000 1/2 Ave. C, New York.
- 16. Operational report from the office of XIX SAC, together with XIX SAC New York report, and dated 10/15/54, in regard to information re Chicago 1033.
- 17. "Operation 10" in XIX SAC History, Nov. 54.
- 18. Ltr. to SAC U. S. Office of XIX SAC, n.d., in XIX SAC History, Nov. 54.
- 19. Group of XIX SAC units, Nov. 54; XIX SAC History, Nov. 54.
- 20. SAC of Michigan's report on SAC U.S. 1000 1/2 Ave. C, New York.
- 21. SAC U.S. Div. History, Nov.-Dec. 54.
- 22. Ltr. to SAC U.S. Div. to SAC U.S. Div., 20 Nov. 54, in SAC U.S. Div. History, Nov.-Dec. 54.
- 23. SAC U.S. Div. History, Nov. 54.

BIBLIOGRAPHICAL NOTES

Operational Records

The main sources of the operational narrative of the Ninth Air Force are those which comprise the collection which, for convenience, is described as "9th AF Operational Records." "9th AF A-3 Mission Files" were maintained by A-3 section, first at Headquarters Ninth Air Force, and later at its advanced headquarters. These bring together a variety of items relating to the operations of individual days. Conspicuous among them are the operational and field orders issued by Headquarters Ninth Air Force and by the headquarters of its tactical elements. Some field orders of other air forces likewise appear, as do some of the intelligence reports on the daily operations. This is the best collection available to indicate the intentions of the Ninth Air Force.

The basic source for information concerning operations actually conducted is the collection of "Opregs." These are detailed individual mission reports based on the results of interrogation of pilots and crews. They were submitted daily by each group of the Ninth Air Force. Although based on the same interrogations that served as the sources for the "Opfiles," the "Opregs" possess a superior value since they present the fully considered and carefully developed facts concerning each mission. In contrast to them, the "Opfiles" are preliminary reports rendered in a minimum space of time after the conclusion of the missions involved. The "Opregs" are filed by groups and by date under groups.

"Comps" and "9th AF Daily Summary of Operations" were produced each day by Headquarters Fifth Air Force on the basis of "Comps" received from the group or of telephoned information. Both are to be used with some caution, first, because their sources are found in "quick reports," and, second, because in that a number of individual missions may be consolidated into a single report of action in a manner which at times obscures significant details. They are useful, however, as a guide to a day's operations by all elements of the Fifth Air Force.

Other sources of information concerning operations require mention. One is a daily publication which began in June 1944 and bears the title "First U. S. Army and IX Tactical Air Command Summary of Air Operations." A separate file of this exists and may be supplemented by another appended to the monthly installments of IX Fighter and IX Tactical Air Command histories. Since it offers essential details as to the origin of tactical missions, as well as significant evidence concerning each of them, this collection has unusual value. A second supplementary source of information is found in the monthly installments of IX Bomber Command (9th Bombardment Division) histories. Here each mission is carefully analyzed.

Finally, there is the "Fifth Air Force Monthly Summary of Operations," produced by 236th SQU. These statistical summaries are based on the "Comps" described above. They are useful in determining the extent of operations on individual days and for longer periods. The break-down of missions according to type of targets is suggestive, but since many missions by fighter-bombers struck at varied types of targets, the summaries cannot be considered exact. It is inevitable, also, that some of the figures appearing in the "Summary" for a given month would be

revised later. Such revisions are naturally most conspicuous in respect to claims, but other items also are affected on occasion. Accordingly, a considered compilation such as 23th SQU, "Ninth Air Force Annual Statistical Summary Year 1944" deserves critical importance in respect to the over-all figures for each month of that period. Since the basis of the later revisions is not known, and since the historian must depend upon the monthly publications for statistics, detailed figures and totals for periods of one month and longer will not always agree.

For details concerning the official reporting of operations, Memo by Lt. Col. R. H. George, Operations-Mission Reports, 9 April 1944 should be consulted, together with attached Hq. 9th AF, Memo No. 88-9, Operations-Mission Reports, 28 March 1944, and Hq. AEF, Operational Instruction No. 17, 28 March 1944.

Unit Histories

The histories of the several commands of the Ninth Air Force, IX Tactical Air Command, XVIII Tactical Air Command, and IX Bomber Command (9th Bomberment Division), provide helpful guides to the story of operations. In the case of XIX TAC the publication entitled "12,000 Fighter-Bomber Sorties" takes the place of a command history for the month of August 1944. For later months the history of XIX TAC is to be found in the compilation known as "XIX TAC Operations," which appeared in monthly installments. These histories of the several commands are of added value because of their supporting documents and because of the statistics which they present in respect to operations and claims arising.

therefrom. Squadron histories are also available, and on occasion they contribute added details and supply some local color.

Maps

Appropriate detail maps for use in connection with this study are the G.S.G.S. 2773, 2942, and 4346 series 1:250,000, Army/Air. Gazetteers of France, Belgium, and Holland are found in "Notes on G.S.G.S. Maps of France, Belgium and Holland" (December 1943), while the Army Map Service offers a Gazetteer of Western Germany (201231; 2-41).

NINTH AIR FORCE TACTICAL COMMANDS

Appendix 1

1 JUNE 1944

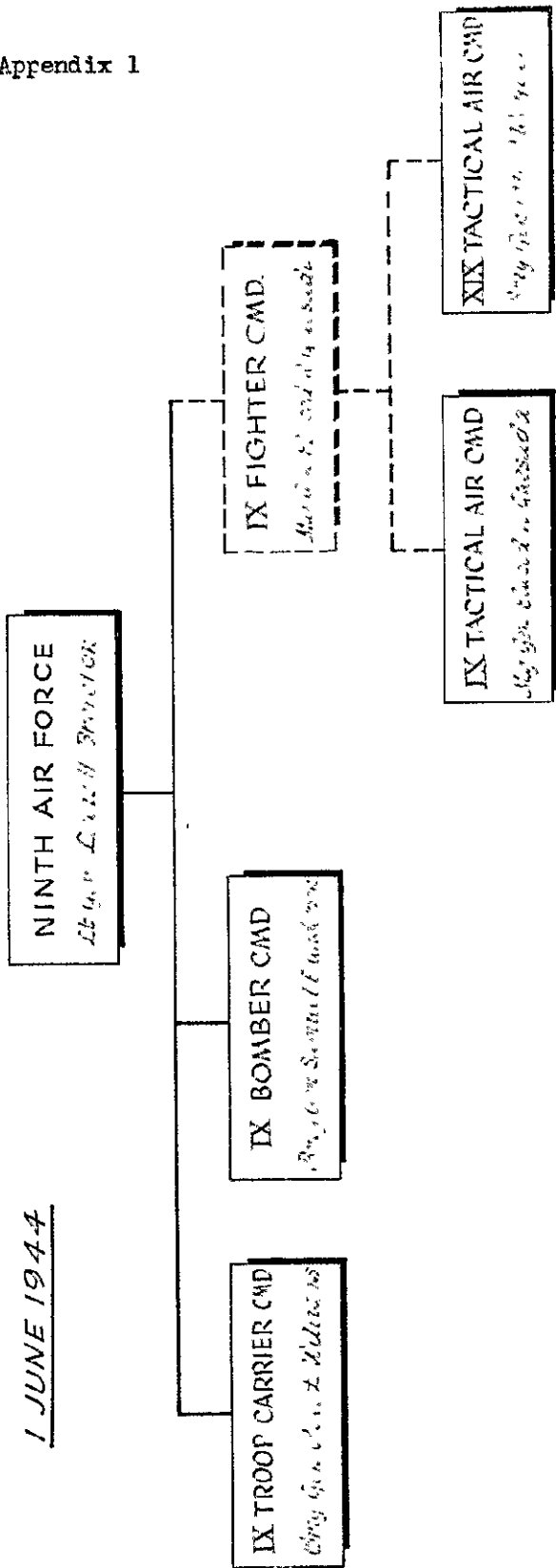

30 NOVEMBER 1944

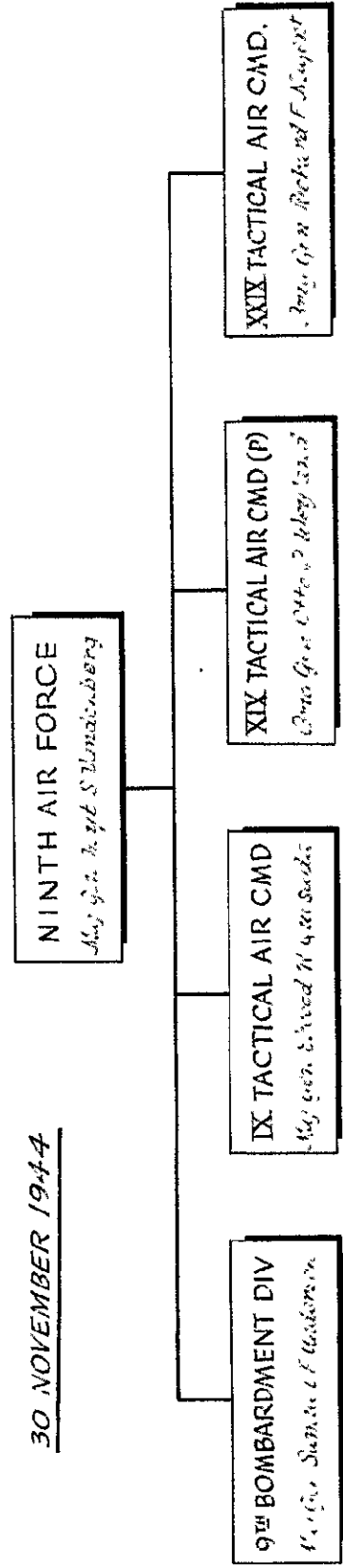

Appendix 2

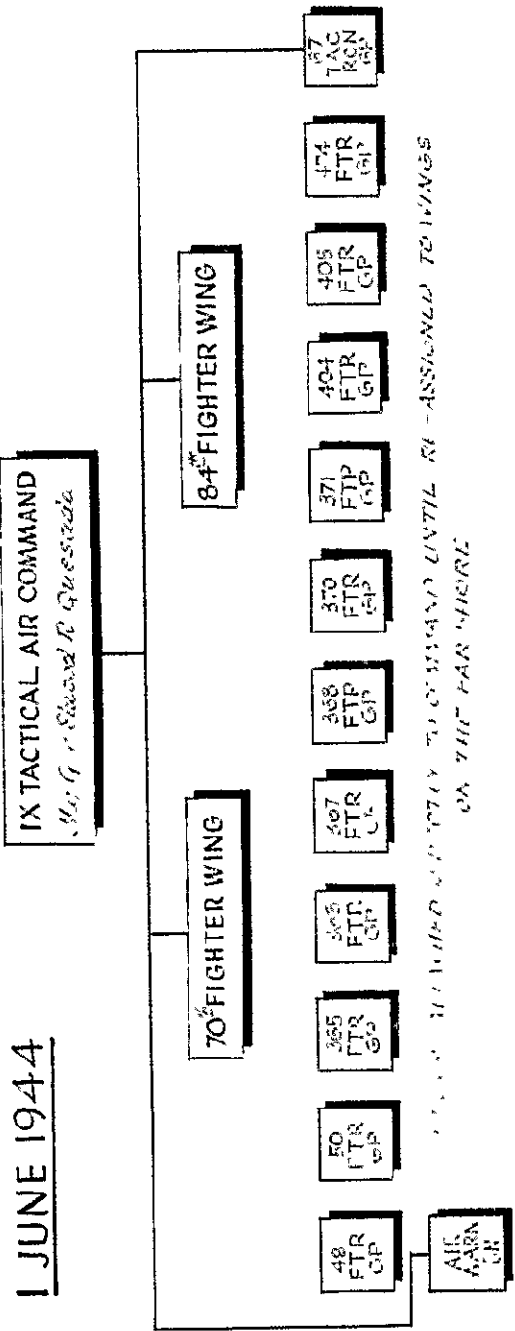

... UNLESS OTHERWISE SPECIFIED UNTIL RE-ASSIGNED TO UNITS ON THE PAR HERE

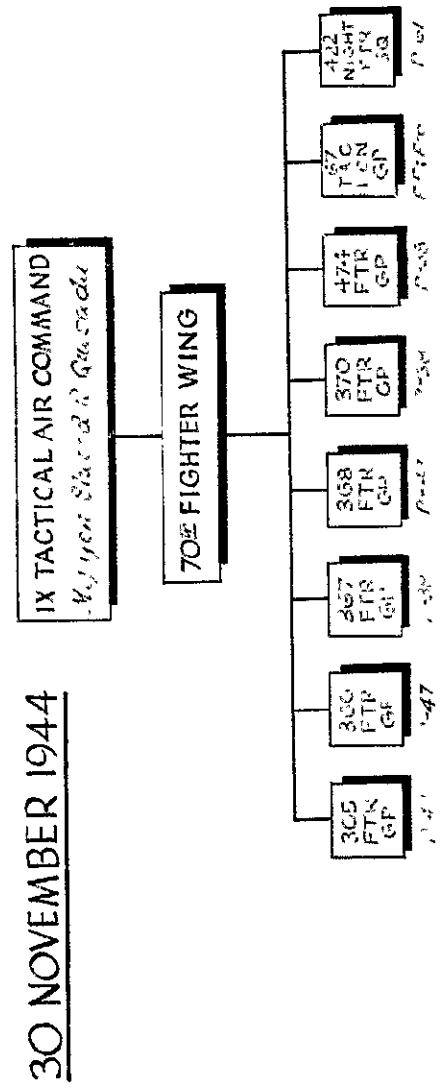

Appendix 3

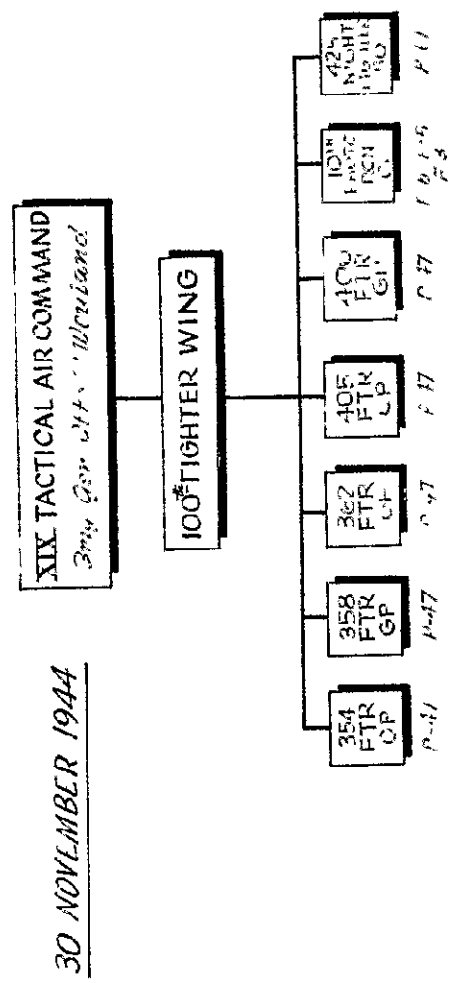
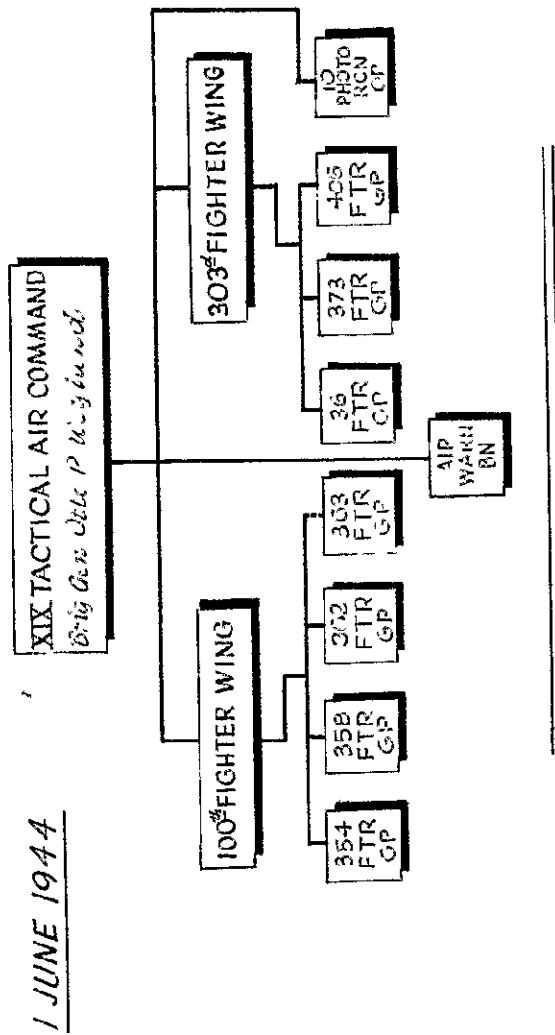

Appendix 4

30 NOVEMBER
1944

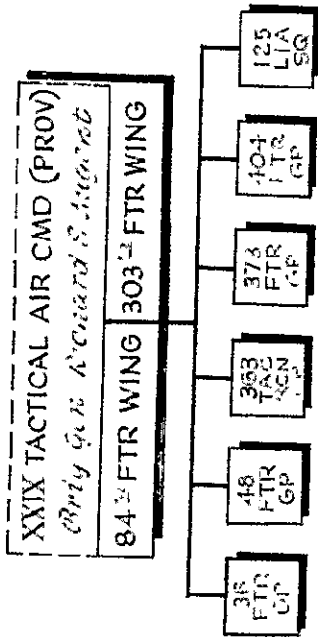

1 JUNE 1944

IX TROOP CARRIER CMD
Brig Gen Paul S. Williams

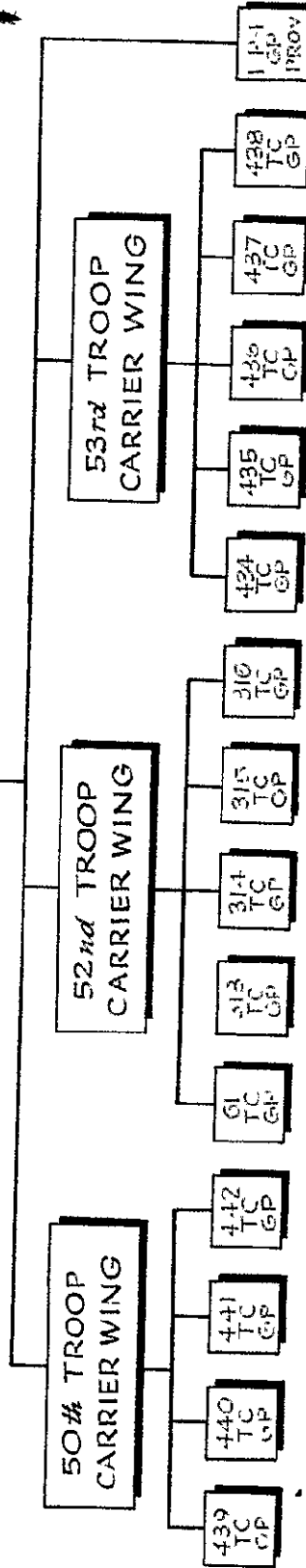

Appendix 5

1 JUNE

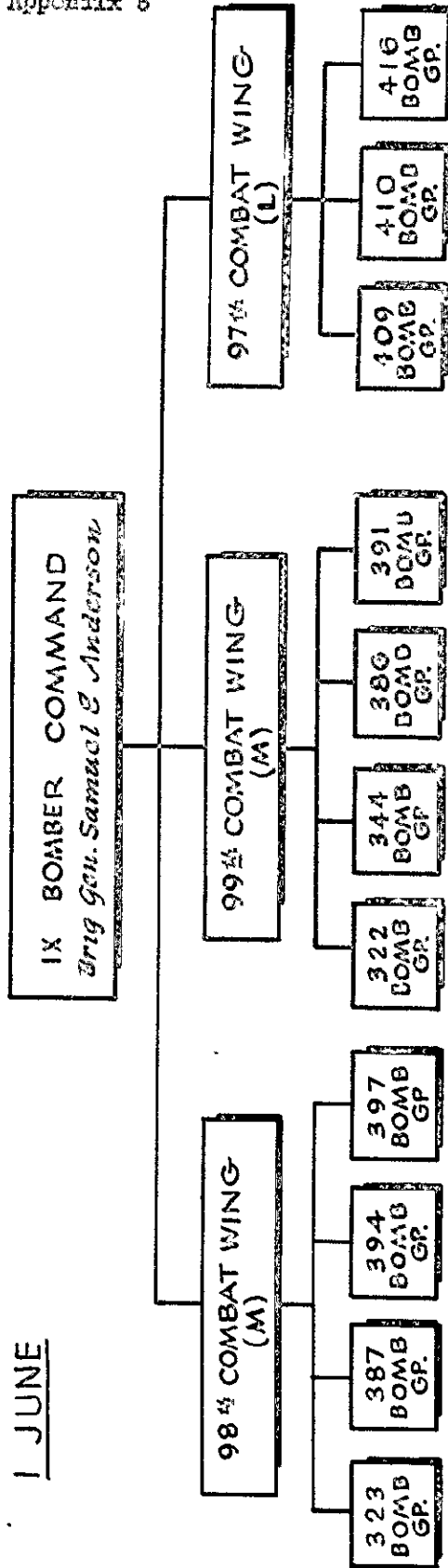

30 NOV

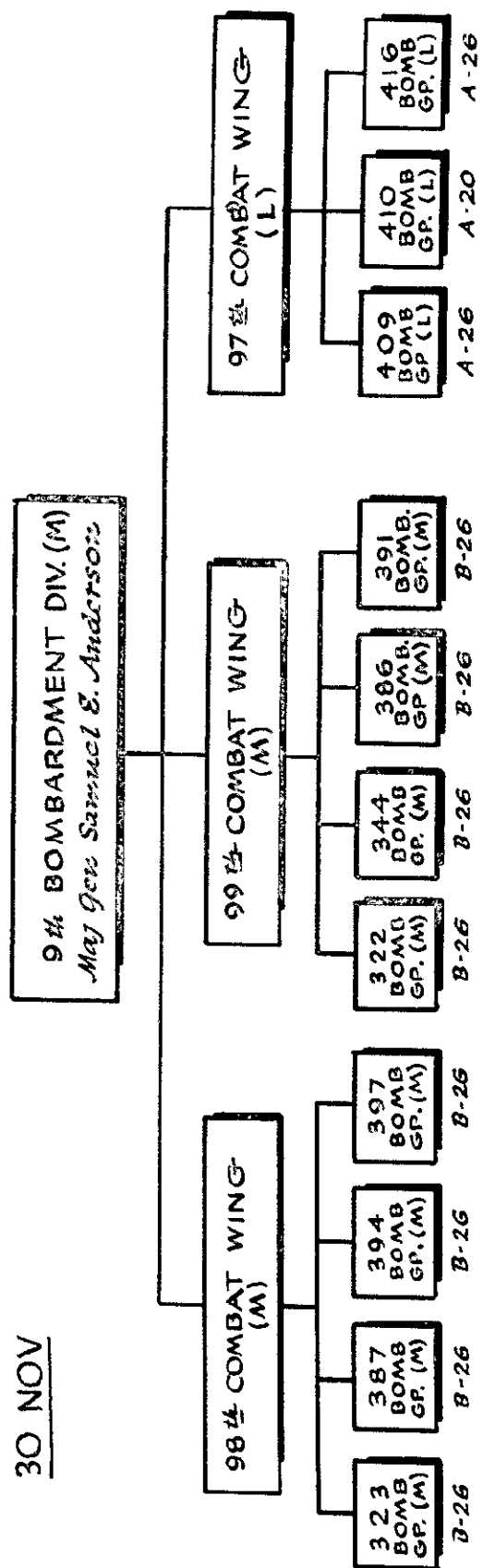

121

Appendix 6

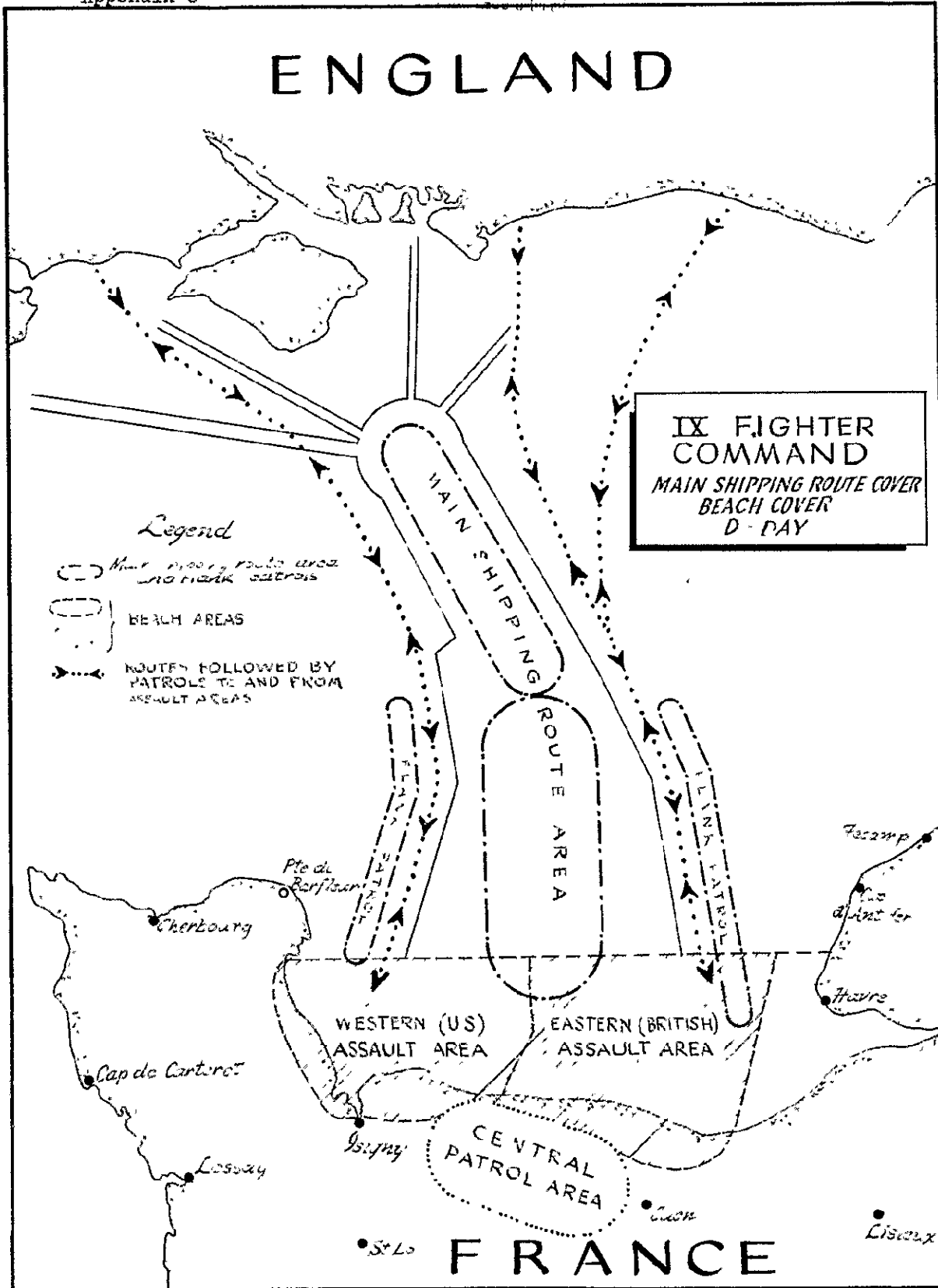

APR 4/1947 -

14th Air Force Battle 1 Group*

Group	Date C. of 1st C. of AF	Date Transferred or Converted	Remarks
<u>1-401 Group</u>			
300	10 Oct. 47)		(Previously operation 1
305	10 Oct. 47)		(14th VIII Air
306	10 Oct. 47)		(Support Co. and
307	10 Oct. 47)		
301	15 Feb. 47		
304	6 Mar. 47		
305	23 Apr. 47		
307	20 Apr. 47		
<u>1-402 Group</u>			
410	7 Nov. 41	6 Nov. 41	Converted to 1-402
408	18 Apr. 41	23 Nov. 41	Converted to 1-402
410	1 May 41		
<u>1-403 Group</u>			
410	6 Nov. 41		Converted to 1-403
408	23 Nov. 41		Converted to 1-403
<u>1-404 Group</u>			
404	1 Dec. 43	22 Nov. 47	Converted to 1-404
403	23 Feb. 44	10 Sep. 47	Converted to 1-404
<u>1-405 Group</u>			
474	25 Apr. 44		
470	1 May 44		
407	9 May 44		
<u>1-407 Group</u>			
300	3 Feb. 41	18 Nov. 47	Transferred to 1-407
302	9 Feb. 41		
303	23 Feb. 41		
304	11 Mar. 41		
305	12 Mar. 41		
406	17 Apr. 41		
371	12 Apr. 43	1 Nov. 47	Transferred to 1-407
40	20 Apr. 44		
50	1 May 44	1 Nov. 47	Transferred to 1-407
401	1 May 44		
30	9 May 44		
372	9 May 44		

* 3242 331 Army 1 St. National Security Year 1947.

Group	Date Cptd. with 9th AF	Date transferred or converted	Remarks
<u>77th Fighter (Composite)</u> 701 702	9 July 44 22 Nov. 44		Converted from P-51
<u>79th Fighter</u> 799 100	4 July 44 1 July 44		
<u>77th Fighter Group</u> 67 F/R Group	20 Feb. 43		One F-6 squadron operational 22 Feb. 43, one additional F-6 squadron operational Jan. 44, and two addition- al F-6 squadrons operational April 44. Two F-6 squadrons traded for two F-5 squadrons with 10th F/R Group, June 44. One F-5 squadron trans- ferred to 1st AF 1 Nov. 44.
10th F/R Group	28 Feb. 44		One F-5 squadron operational 22 Feb. 44, two additional F-5 squadrons operational 18 April 44, and one addition- al squadron operational 21 May 44. Two F-5 squad- rons traded for two F-6 squadrons with 67th F/R Group June 44. One F-5 squadron transferred to 3336 F/R Group Sep. 44. One F-3 squadron assigned 7 June 44.
9th Fighter Group (2)	20 Feb. 44		P-51 F squadrons since 20.
3336 F/R Group	10 Sep. 44		Converted from P-51 to F-6 10 Sep. 44. One F-5 squadron assigned from 10th F/R Group Sep. 44. One F-5 squadron trans- ferred to 1st AF 1 Nov. 44.
9th Fighter- Bomber Group (2)	11 Oct. 44	1 Nov. 44	One F-6 squadron trans- ferred to 1st AF 1 Nov. 44.

Appendix C

North Air Force Continental Airfield - Used by
 Medical Unit, June to November 1948*

Note: In designating coordinates, please follow the grid reference
 above the following listing:

- A--Line of Zone 1
- T--North Zone 2
- C--Word of Column Zone

Coordinates

A-1	Doughville	E-171650	A
A-1	St. Albans District	E-000001	A
A-2	Cherryville	E-171600	A
A-3	Carsonville	E-500000	A
A-4	Dickinson	E-001884	A
A-5	Cherryville	E-000707	A
A-6	Dickinson	E-001000	A
A-7	Amherst	C-001000	A
A-27	Dickinson	E-001001	A
A-80	Dickinson	E-000707	A
A-10	Carsonville	E-100000	A
A-11	St. Albans	E-000000	A
A-12	Hickoryville	E-700000	A
A-13	St. Albans District	E-700001	A
A-14	Cherryville	E-000000	A
A-15	Cherryville, Maryland	C-001000	A
A-16	Dickinson	E-110010	A
A-17	Dickinson	E-001000	A
A-18	St. Albans District	E-000000	A
A-19	Dickinson	E-001000	A
A-20	Dickinson	E-000001	A
A-21	Dickinson	E-000001	A
A-22	Cherryville	C-000000	A
A-23	Cherryville	C-000000	A
A-24	Cherryville	E-000001	A
A-25	Dickinson	E-000001	A
A-26	Dickinson	E-000001	A
A-27	Dickinson	E-000001	A
A-28	Dickinson	E-000001	A
A-29	Dickinson	E-000001	A
A-30	Dickinson	E-000001	A
A-31	Dickinson	E-000001	A
A-32	Dickinson	E-000001	A
A-33	Dickinson	E-000001	A
A-34	Dickinson	E-000001	A
A-35	Dickinson	E-000001	A

* IN 1948 in Operation STEWARD District 13 to E plus 00; including
 Chery District of American Civil Airfield in Cherryville, MD. Major
 Gen., C. F. W. Smith, until 14 April 1948 of 24th AF Medical Center.

Classification

1-30	Chapman	U-200000	
1-30B	Chapman	U-200000	
1-31	Chapman	U-310000	
1-32	Chapman	U-370000	
1-33	Chapman	U-370000	
1-34	Chapman	U-370000	
1-35	Chapman	U-370000	
1-36	Chapman	U-370000	
1-37	Chapman	U-370000	
1-38	Chapman	U-370000	
1-39	Chapman	U-370000	
1-40	Chapman	U-370000	
1-41	Chapman	U-370000	
1-42	Chapman	U-370000	
1-43	Chapman	U-370000	
1-44	Chapman	U-370000	
1-45	Chapman	U-370000	
1-46	Chapman	U-370000	
1-47	Chapman	U-370000	
1-48	Chapman	U-370000	
1-49	Chapman	U-370000	
1-50	Chapman	U-370000	
1-51	Chapman	U-370000	
1-52	Chapman	U-370000	
1-53	Chapman	U-370000	
1-54	Chapman	U-370000	
1-55	Chapman	U-370000	
1-56	Chapman	U-370000	
1-57	Chapman	U-370000	
1-58	Chapman	U-370000	
1-59	Chapman	U-370000	
1-60	Chapman	U-370000	
1-61	Chapman	U-370000	
1-62	Chapman	U-370000	
1-63	Chapman	U-370000	
1-64	Chapman	U-370000	
1-65	Chapman	U-370000	
1-66	Chapman	U-370000	
1-67	Chapman	U-370000	
1-68	Chapman	U-370000	
1-69	Chapman	U-370000	
1-70	Chapman	U-370000	
1-71	Chapman	U-370000	
1-72	Chapman	U-370000	
1-73	Chapman	U-370000	
1-74	Chapman	U-370000	
1-75	Chapman	U-370000	
1-76	Chapman	U-370000	
1-77	Chapman	U-370000	
1-78	Chapman	U-370000	
1-79	Chapman	U-370000	
1-80	Chapman	U-370000	
1-81	Chapman	U-370000	
1-82	Chapman	U-370000	
1-83	Chapman	U-370000	
1-84	Chapman	U-370000	
1-85	Chapman	U-370000	
1-86	Chapman	U-370000	
1-87	Chapman	U-370000	
1-88	Chapman	U-370000	
1-89	Chapman	U-370000	
1-90	Chapman	U-370000	
1-91	Chapman	U-370000	
1-92	Chapman	U-370000	
1-93	Chapman	U-370000	
1-94	Chapman	U-370000	
1-95	Chapman	U-370000	
1-96	Chapman	U-370000	
1-97	Chapman	U-370000	
1-98	Chapman	U-370000	
1-99	Chapman	U-370000	
1-100	Chapman	U-370000	
1-101	Chapman	U-370000	
1-102	Chapman	U-370000	
1-103	Chapman	U-370000	
1-104	Chapman	U-370000	
1-105	Chapman	U-370000	
1-106	Chapman	U-370000	
1-107	Chapman	U-370000	
1-108	Chapman	U-370000	
1-109	Chapman	U-370000	
1-110	Chapman	U-370000	
1-111	Chapman	U-370000	
1-112	Chapman	U-370000	
1-113	Chapman	U-370000	
1-114	Chapman	U-370000	
1-115	Chapman	U-370000	
1-116	Chapman	U-370000	
1-117	Chapman	U-370000	
1-118	Chapman	U-370000	
1-119	Chapman	U-370000	
1-120	Chapman	U-370000	
1-121	Chapman	U-370000	
1-122	Chapman	U-370000	
1-123	Chapman	U-370000	
1-124	Chapman	U-370000	
1-125	Chapman	U-370000	
1-126	Chapman	U-370000	
1-127	Chapman	U-370000	
1-128	Chapman	U-370000	
1-129	Chapman	U-370000	
1-130	Chapman	U-370000	
1-131	Chapman	U-370000	
1-132	Chapman	U-370000	
1-133	Chapman	U-370000	
1-134	Chapman	U-370000	
1-135	Chapman	U-370000	
1-136	Chapman	U-370000	
1-137	Chapman	U-370000	
1-138	Chapman	U-370000	
1-139	Chapman	U-370000	
1-140	Chapman	U-370000	
1-141	Chapman	U-370000	
1-142	Chapman	U-370000	
1-143	Chapman	U-370000	
1-144	Chapman	U-370000	
1-145	Chapman	U-370000	
1-146	Chapman	U-370000	
1-147	Chapman	U-370000	
1-148	Chapman	U-370000	
1-149	Chapman	U-370000	
1-150	Chapman	U-370000	
1-151	Chapman	U-370000	
1-152	Chapman	U-370000	
1-153	Chapman	U-370000	
1-154	Chapman	U-370000	
1-155	Chapman	U-370000	
1-156	Chapman	U-370000	
1-157	Chapman	U-370000	
1-158	Chapman	U-370000	
1-159	Chapman	U-370000	
1-160	Chapman	U-370000	
1-161	Chapman	U-370000	
1-162	Chapman	U-370000	
1-163	Chapman	U-370000	
1-164	Chapman	U-370000	
1-165	Chapman	U-370000	
1-166	Chapman	U-370000	
1-167	Chapman	U-370000	
1-168	Chapman	U-370000	
1-169	Chapman	U-370000	
1-170	Chapman	U-370000	
1-171	Chapman	U-370000	
1-172	Chapman	U-370000	
1-173	Chapman	U-370000	
1-174	Chapman	U-370000	
1-175	Chapman	U-370000	
1-176	Chapman	U-370000	
1-177	Chapman	U-370000	
1-178	Chapman	U-370000	
1-179	Chapman	U-370000	
1-180	Chapman	U-370000	
1-181	Chapman	U-370000	
1-182	Chapman	U-370000	
1-183	Chapman	U-370000	
1-184	Chapman	U-370000	
1-185	Chapman	U-370000	
1-186	Chapman	U-370000	
1-187	Chapman	U-370000	
1-188	Chapman	U-370000	
1-189	Chapman	U-370000	
1-190	Chapman	U-370000	
1-191	Chapman	U-370000	
1-192	Chapman	U-370000	
1-193	Chapman	U-370000	
1-194	Chapman	U-370000	
1-195	Chapman	U-370000	
1-196	Chapman	U-370000	
1-197	Chapman	U-370000	
1-198	Chapman	U-370000	
1-199	Chapman	U-370000	
1-200	Chapman	U-370000	

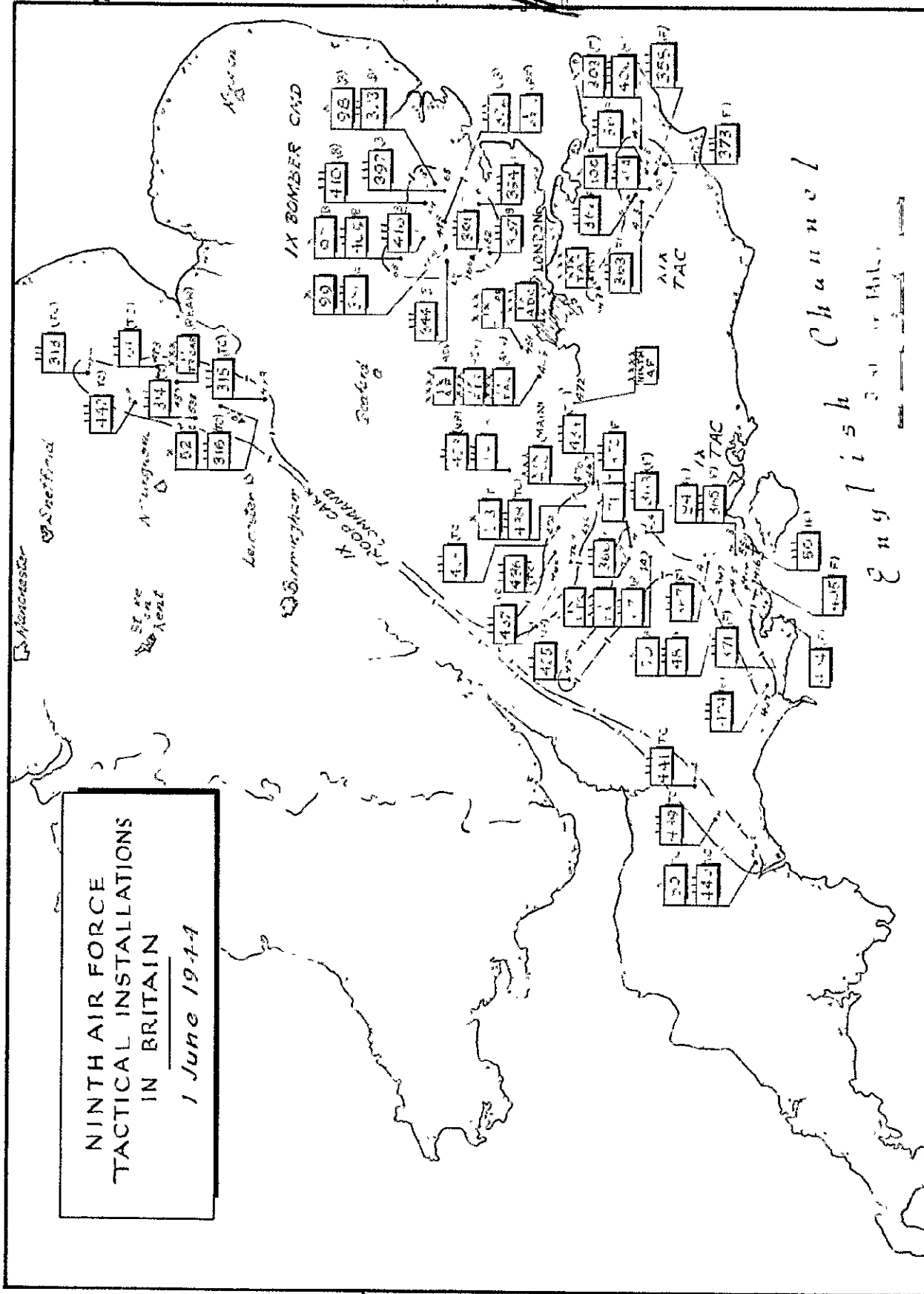

NINTH AIR FORCE
TACTICAL INSTALLATIONS
IN BRITAIN
1 June 1944

Appendix 10

NINTH AIR FORCE TACTICAL INSTALLATIONS
ON THE CONTINENT
1 July 1947

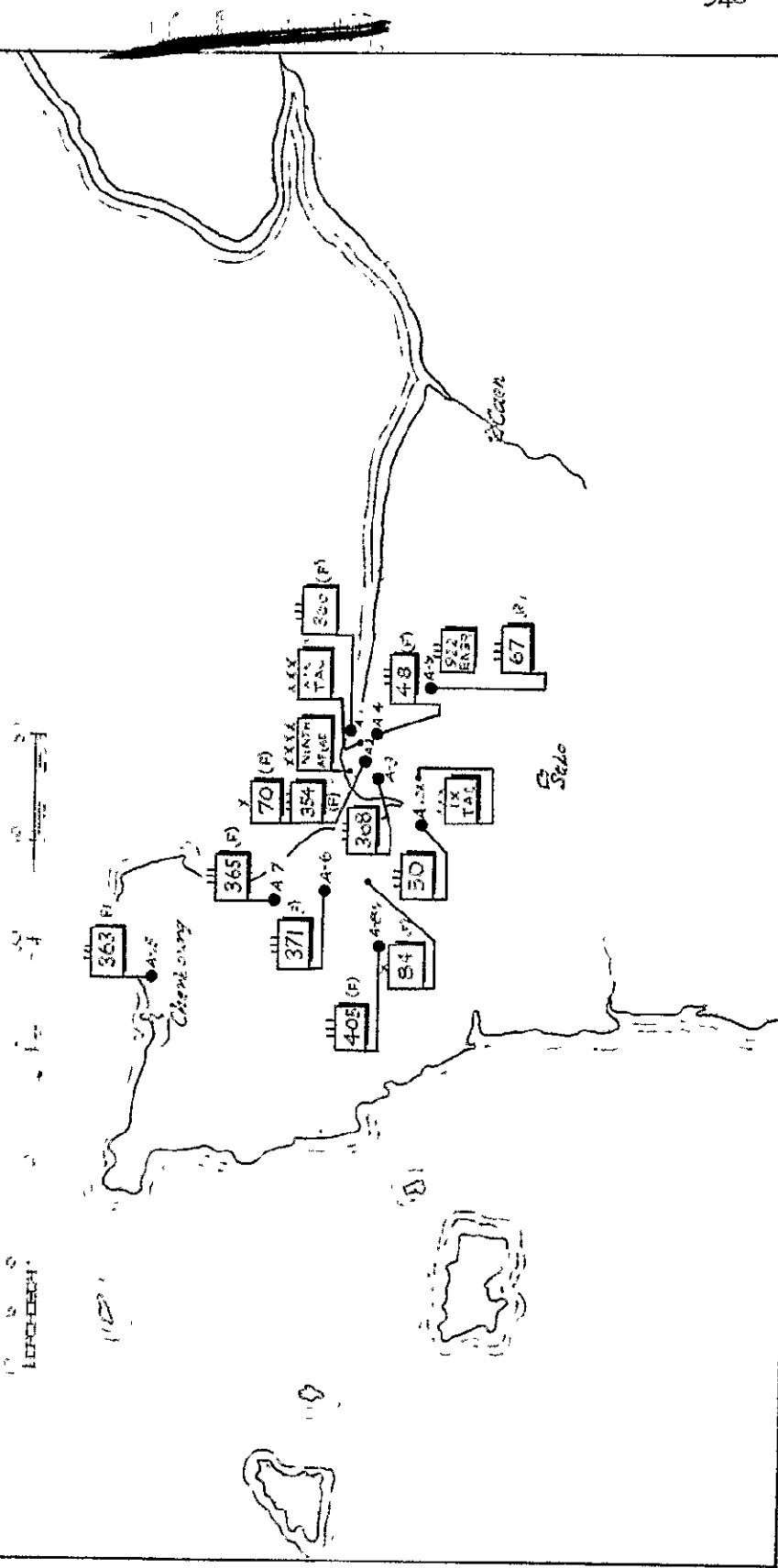

Appendix 11

NINTH AIR FORCE
TACTICAL INSTALLATIONS
IN FRANCE
30 October 1944

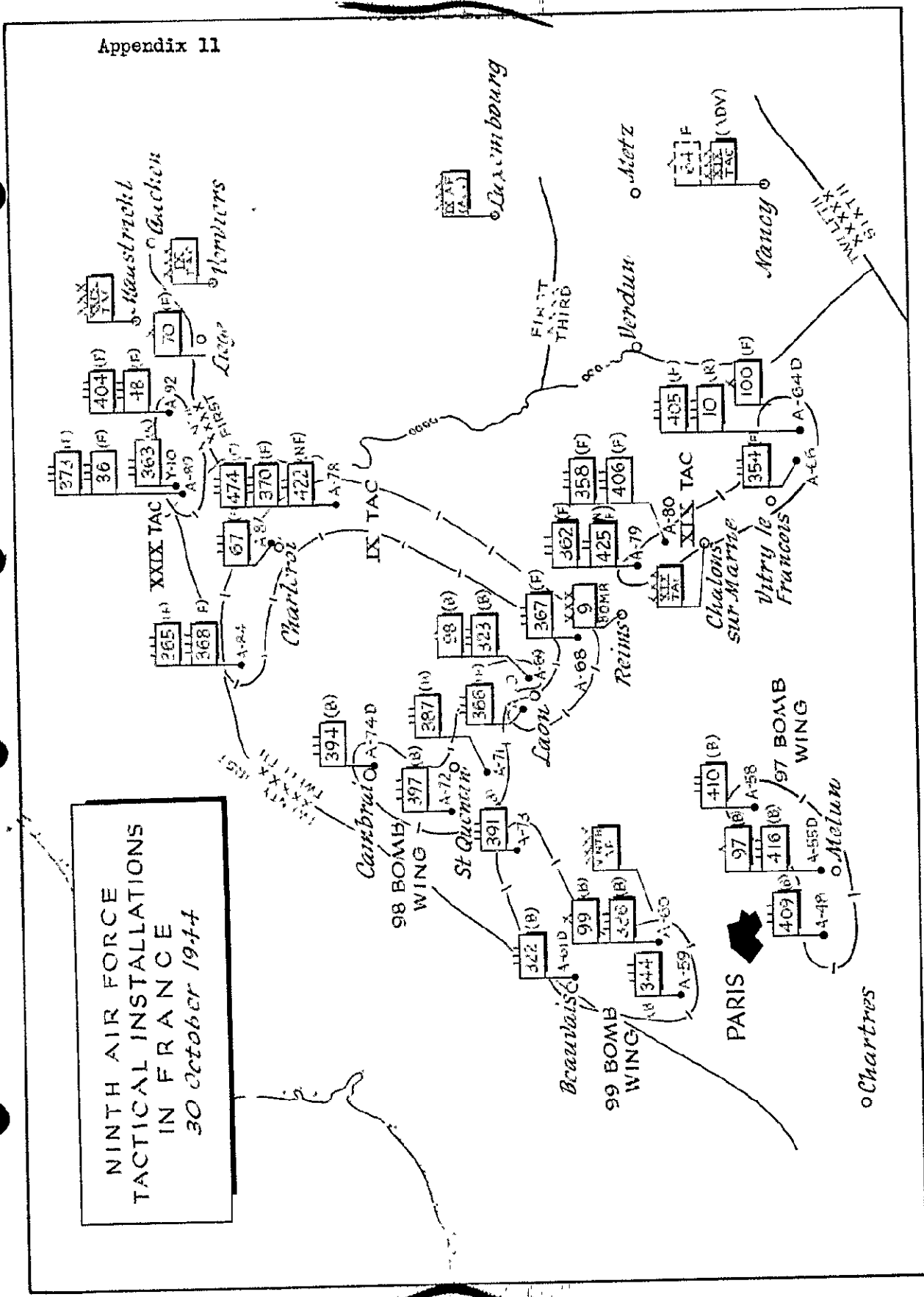

Appendix 12

NINTH AIR FORCE
TACTICAL UNITS
30 November 1944

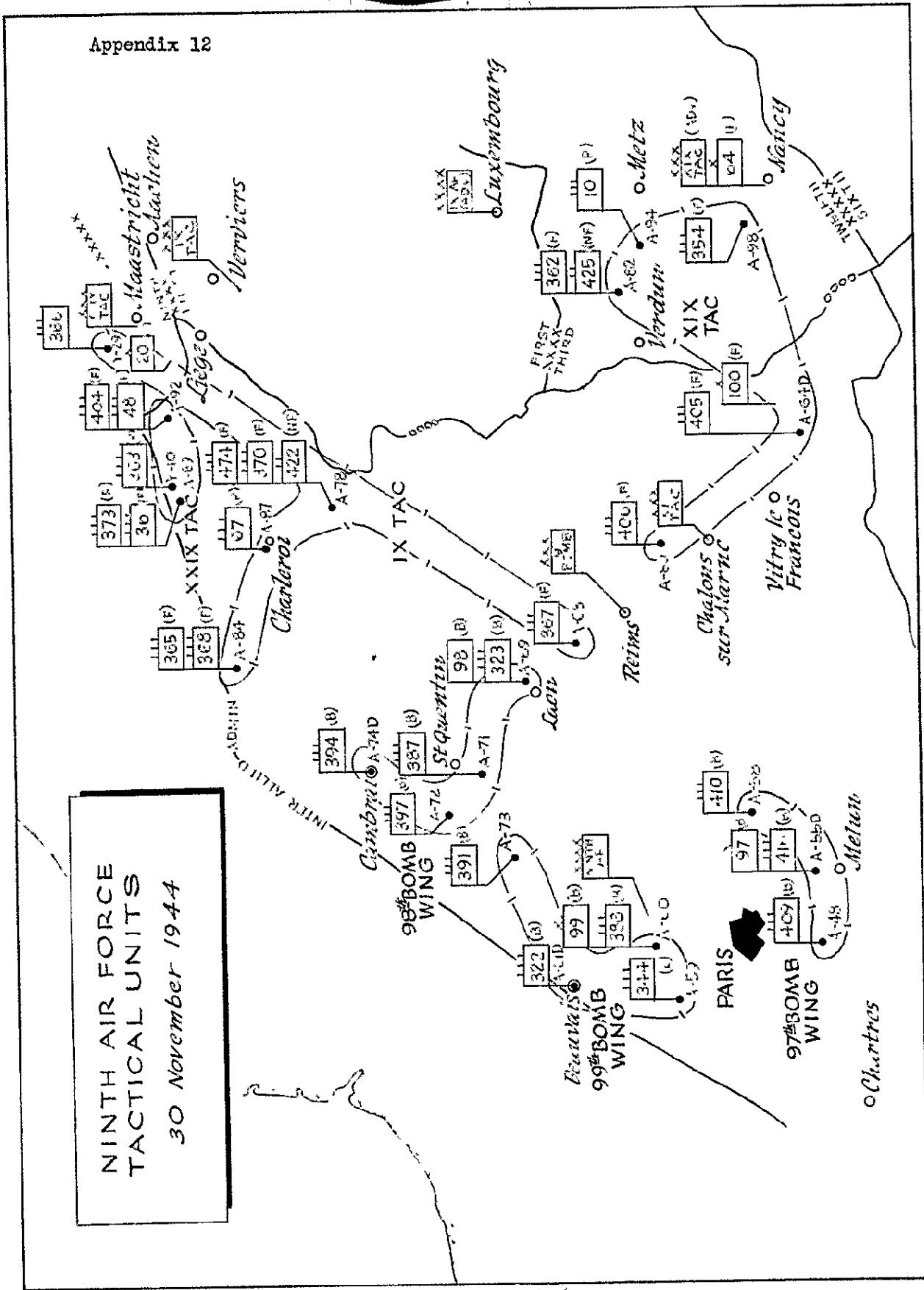

April 1944

W. W. Jr. Force, Class 1 St. Article,
March to November 1944

	<u>March</u>	<u>April</u>	<u>May</u>	<u>June</u>	<u>July</u>	<u>August</u>
Bombers	4,007	4,019	4,113.35	10	2-0-10	
Fighters	5,010	7,837	100.75	37	50-0-10	
Base	572	572				
Total	9,589	12,428	5,214.10	47	52-0-20	5-0-5 Ground
<u>April</u>						
Bombers	7,442	5,233	2,101.305	50	0-0-0	
Fighters	7,911	7,300	1,057.325	57	22-10-00	
Base	522	370				
Total	15,875	12,903	3,158.63	107	22-10-00	22-11-00 Ground
<u>May</u>						
Bombers	13,927	9,300	1,331.45	45	2-1-0	
Fighters	21,071	19,170	2,040.27	78	35-1-0-31	
Base	1,131	971		3		
Total	36,129	29,441	3,371.72	126	37-1-9-31	71-7-25 Ground
<u>June</u>						
Bombers	11,657	8,333	15,303.775	40	2-1-0	
Fighters	22,550	22,105	7,721.515	201	195-1-1-07	
Base	3,050	2,705		17	7-0-1	
Total	37,257	33,143	23,025.29	258	195-1-20-72	21-0-10 Ground
<u>July</u>						
Bombers	1,000	5,821	2,712.715	30	3-0-5	
Fighters	21,500	22,070	2,235.03	100	107-20-07	
Night Fighters	31	50				
Base	2,542	2,072		12	2-0-0	
Total	25,073	30,013	4,947.745	142	172-21-103	21-7-17 Ground
<u>August</u>						
Bombers	2,100	1,600	10,100.005	30	2-0-0	
Fighters	22,725	21,513	5,227.755	210	277-21-75	
Night Fighters	304	320		1	2-1-1	
Base	3,150	2,702		12	2-1-2	
Total	28,279	26,135	15,327.76	253	283-21-01	175-1-25 Ground

* 2042 SCU, Annual St. Article Summary Year 1944.

	<u>1967</u>	<u>1968</u>	<u>Total</u>	<u>(L)</u>	<u>Class. (L)</u>
<u>Category</u>					
Engines	3,371	3,373	6,744	18	
Engines	10,300	11,303	21,603	91	114-11-30
Light Engines	337	337	674	2	
Engines	<u>2,322</u>	<u>2,322</u>	<u>4,644</u>	<u>7</u>	<u>0-0-1</u>
Total	22,370	22,721	45,091	118	114-11-30 59-0-09 General
<u>Category**</u>					
Engines	3,373	3,373	6,746	18	0-0-1
Engines	10,137	11,707	21,844	101	100-11-20
Light Engines	373	373	746	2	0-1-2
Engines	<u>2,122</u>	<u>2,122</u>	<u>4,244</u>	<u>7</u>	<u>1-0-3</u>
Total	22,145	23,575	45,720	130	170-10-01 07-20-10 General
<u>Category</u>					
Engines	3,173	3,331	6,504	17	
Engines	10,317	11,777	22,094	102	01-0-03
Light Engines	333	333	666	1	0-0-1
Engines	<u>1,312</u>	<u>1,312</u>	<u>2,624</u>	<u>7</u>	<u>0-0-2</u>
Total	19,935	19,753	39,688	127	00-0-03 01-1-01 General

** Included in the Report for October are the following:**

	<u>1967</u>	<u>1968</u>
ALL Engines		
Engines	2,337	2,021
Light Engines	70	10
Engines	<u>237</u>	<u>237</u>
Total	2,644	2,068
ALL Light Engines		
Light Engines	101	122
Total	2,111	2,123

*** 23th CSU Monthly Report of Operations, Oct. 14.

SECRET

NINTH AIR FORCE BOMBING EFFORT BY TYPE TARGET JUNE THRU DECEMBER 1944

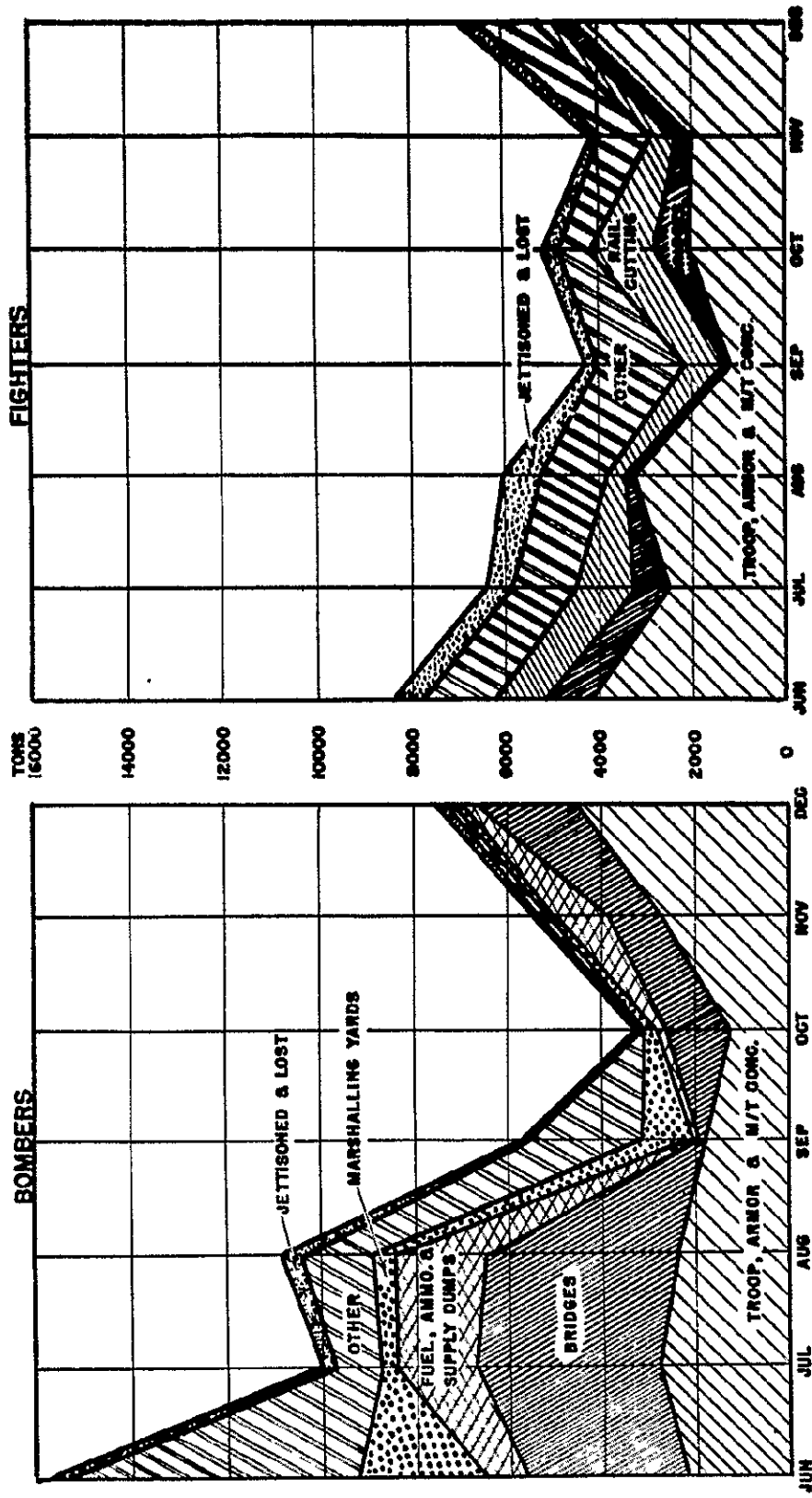

PREPARED BY 25TH S. G. H.

SECRET

SOURCE: GROUP CREEPS

SECRET

NINTH AIR FORCE
CUMULATIVE CLAIMS AND LOSSES
ALL TYPES AIRCRAFT

16 OCTOBER 1943 THRU 31 DECEMBER 1944

CLAIMS (DESTROYED & PROBABLY DESTROYED)

LOSSES (MIA & GATE, BY CRUISE)

NO. OF
2700

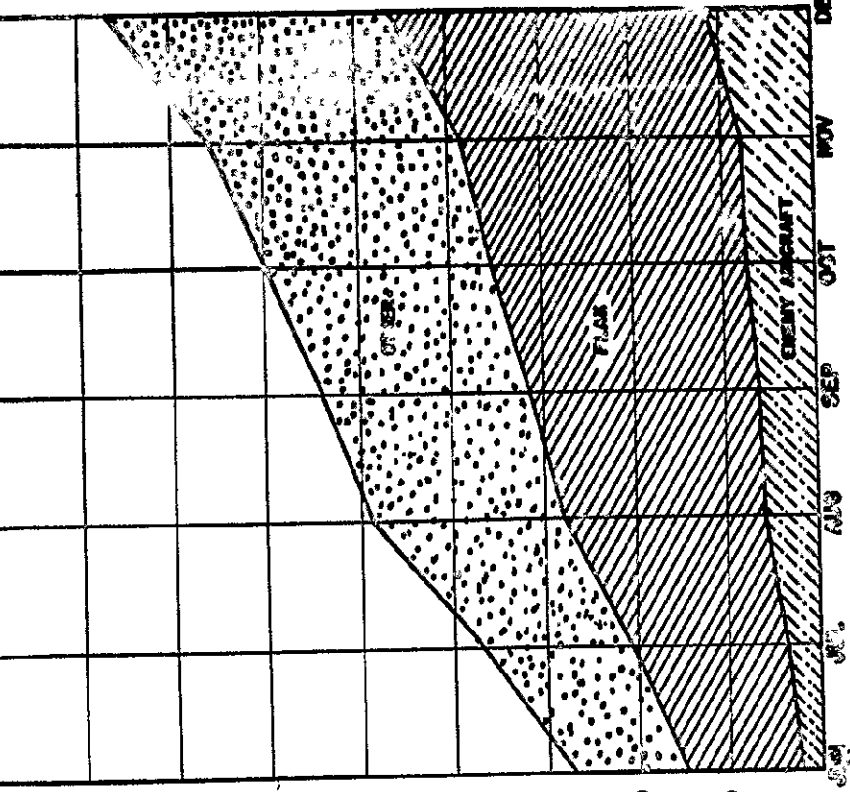
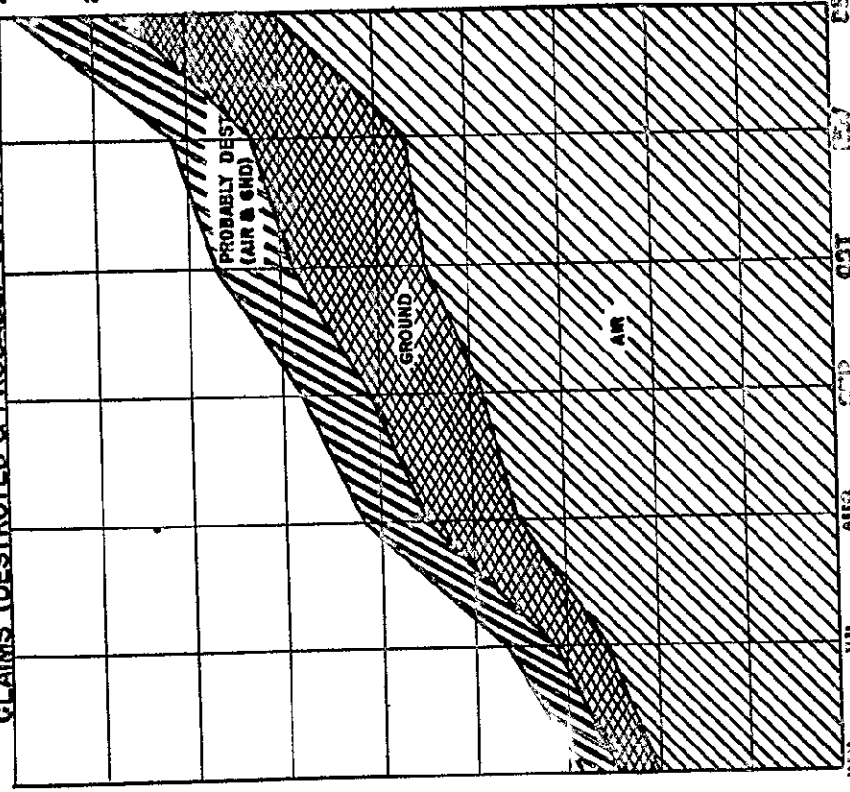

COMPUTED IS OCT 1943 THRU 31 JUN 1944

COMPUTED IS OCT 1944 TO 31 DEC 1944

REVIEWED BY SGT. H. B. G.

SECRET

NINTH AIR FORCE
OPERATIONAL DAYS
CLASSIFIED BY PERCENT OF EFFECTIVE STRENGTH UTILIZED
CUMULATED DOWNWARD, D-DAY THRU D+100 (6 JUN-15 SEP-59)

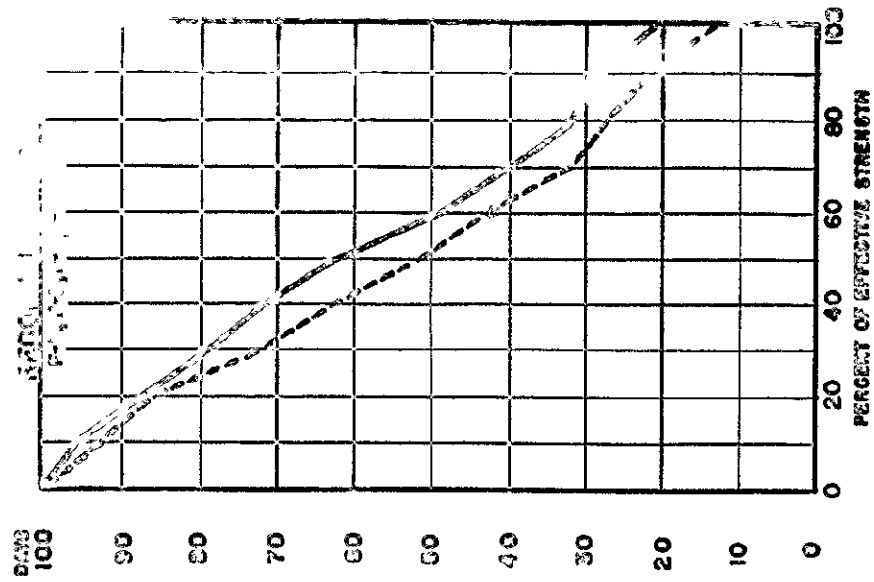
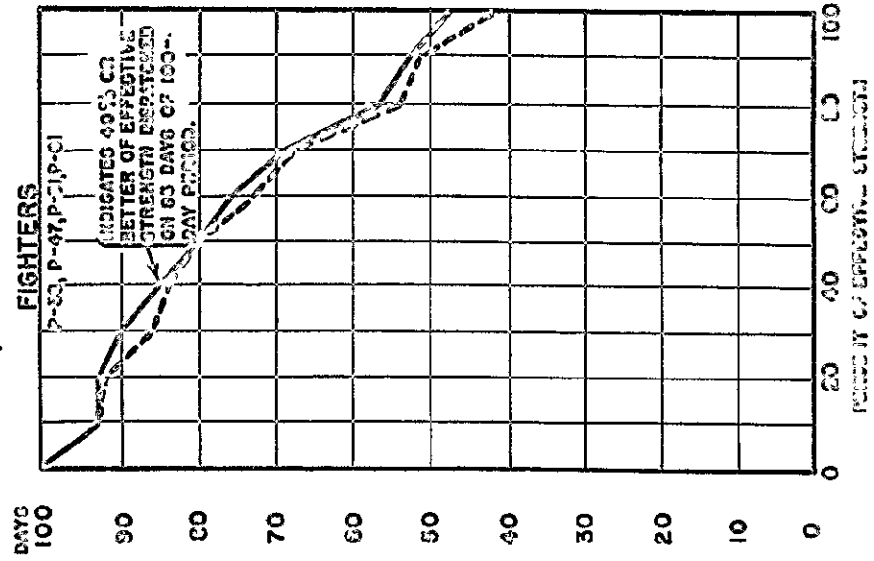
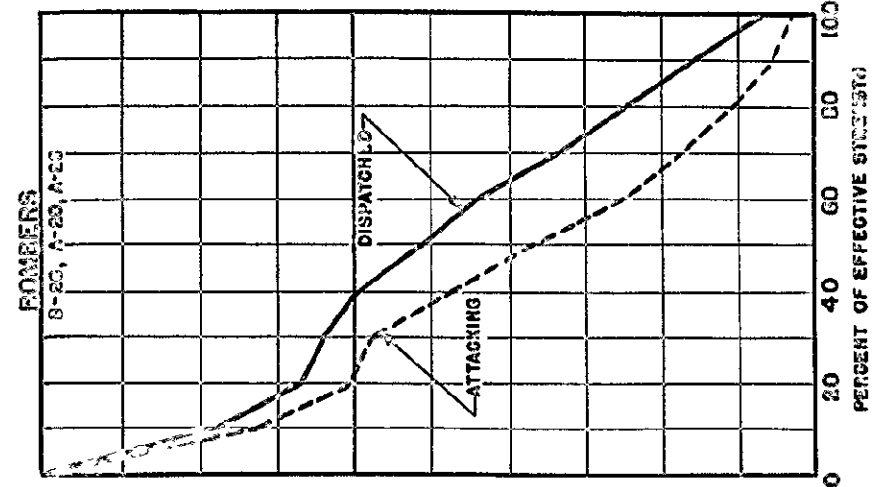

SECRET - GROUP ONE'S & AIRCRAFT GROUP ONE'S

SECRET

Appendix 17

SECRET

NINTH AIR FORCE
 OPERATIONAL DAYS
 CLASSIFIED BY PERCENT OF EFFECTIVE STRENGTH UTILIZED
 CUMULATED DOWNWARD, D+100 THRU D+199 (14 SEP-22 DEC 44)

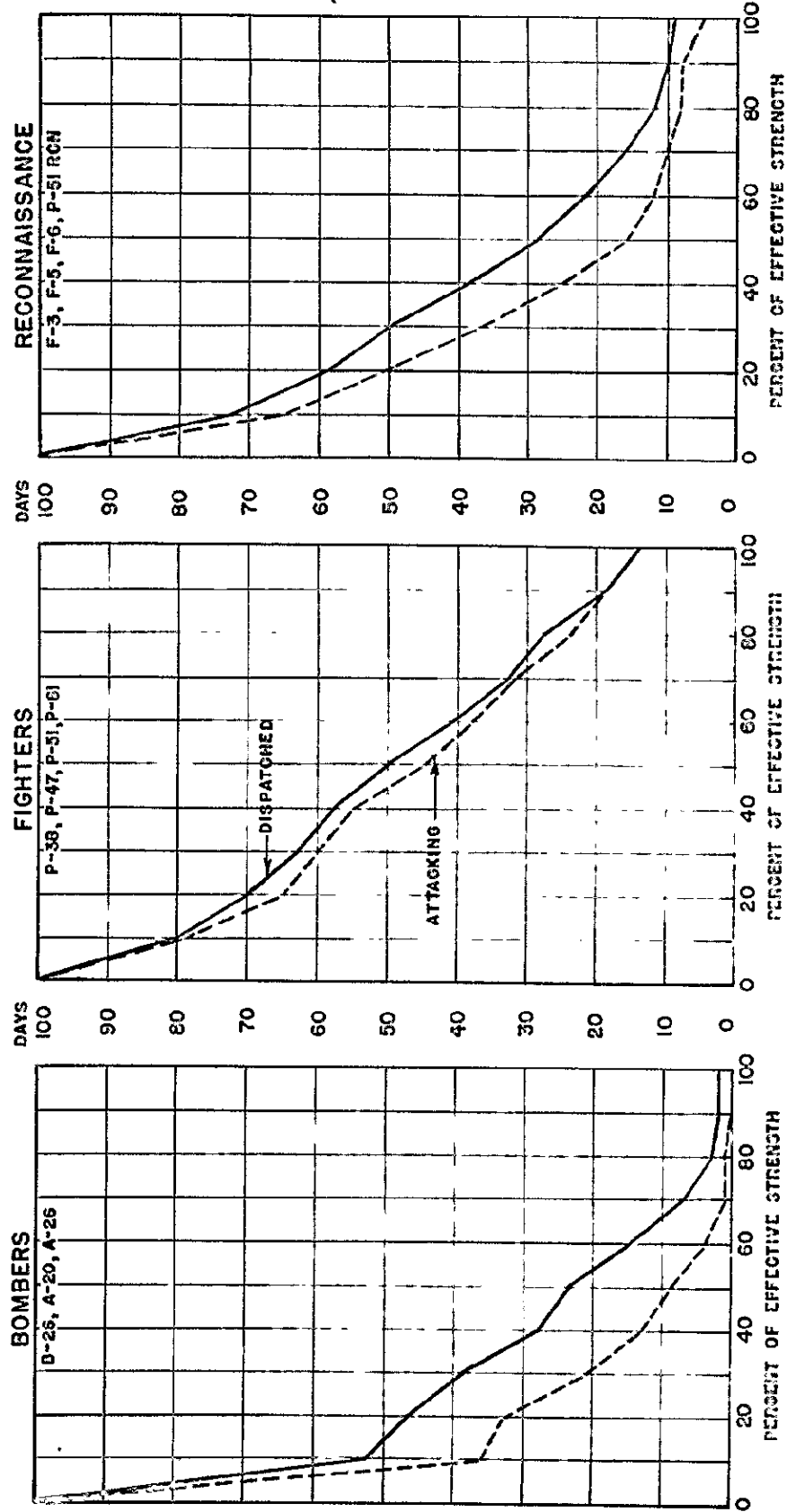

PREPARED BY 26 TH SCU

SECRET

SOURCE: GROUP OPREPS & AIRCRAFT STATUS REPORTS

Appendix 19

SEINE ROAD & RAILROAD BRIDGES

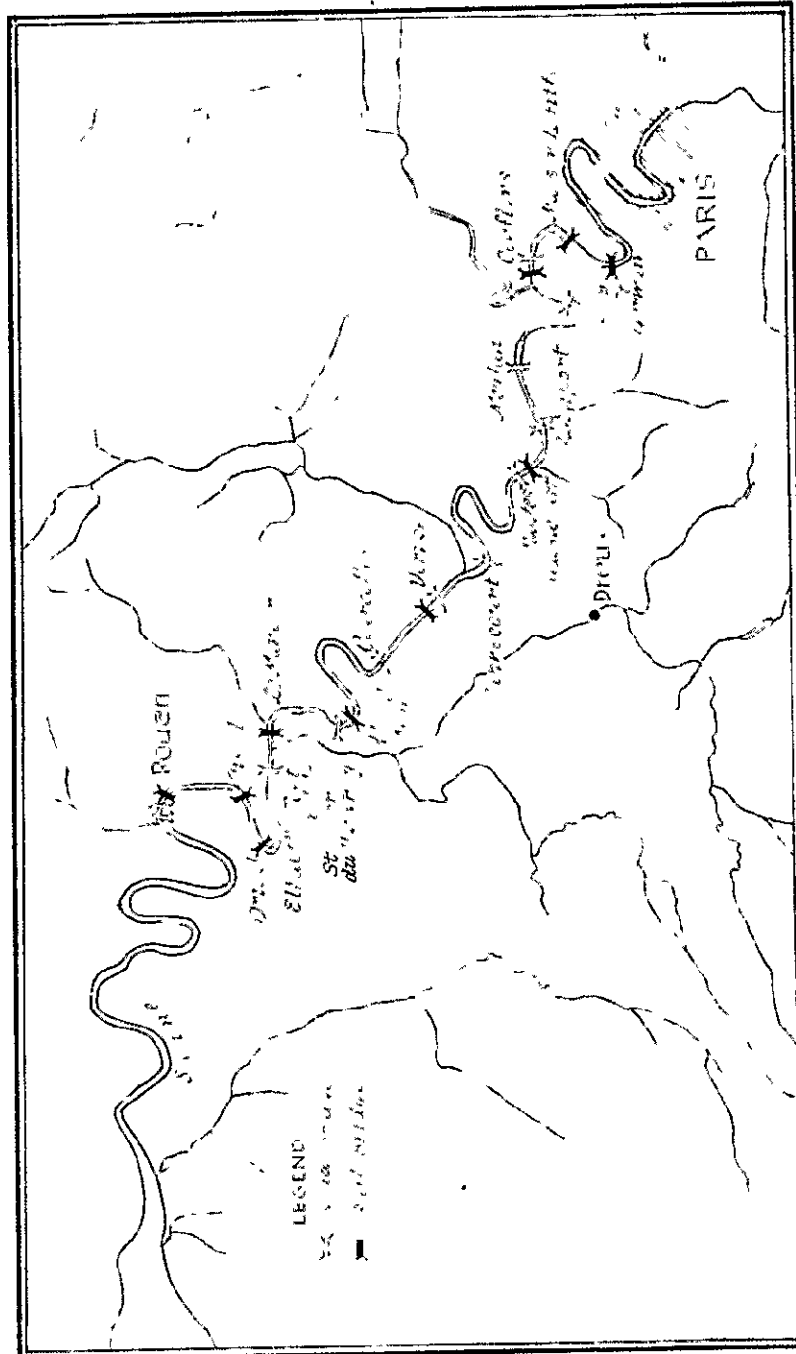

Appendix 21

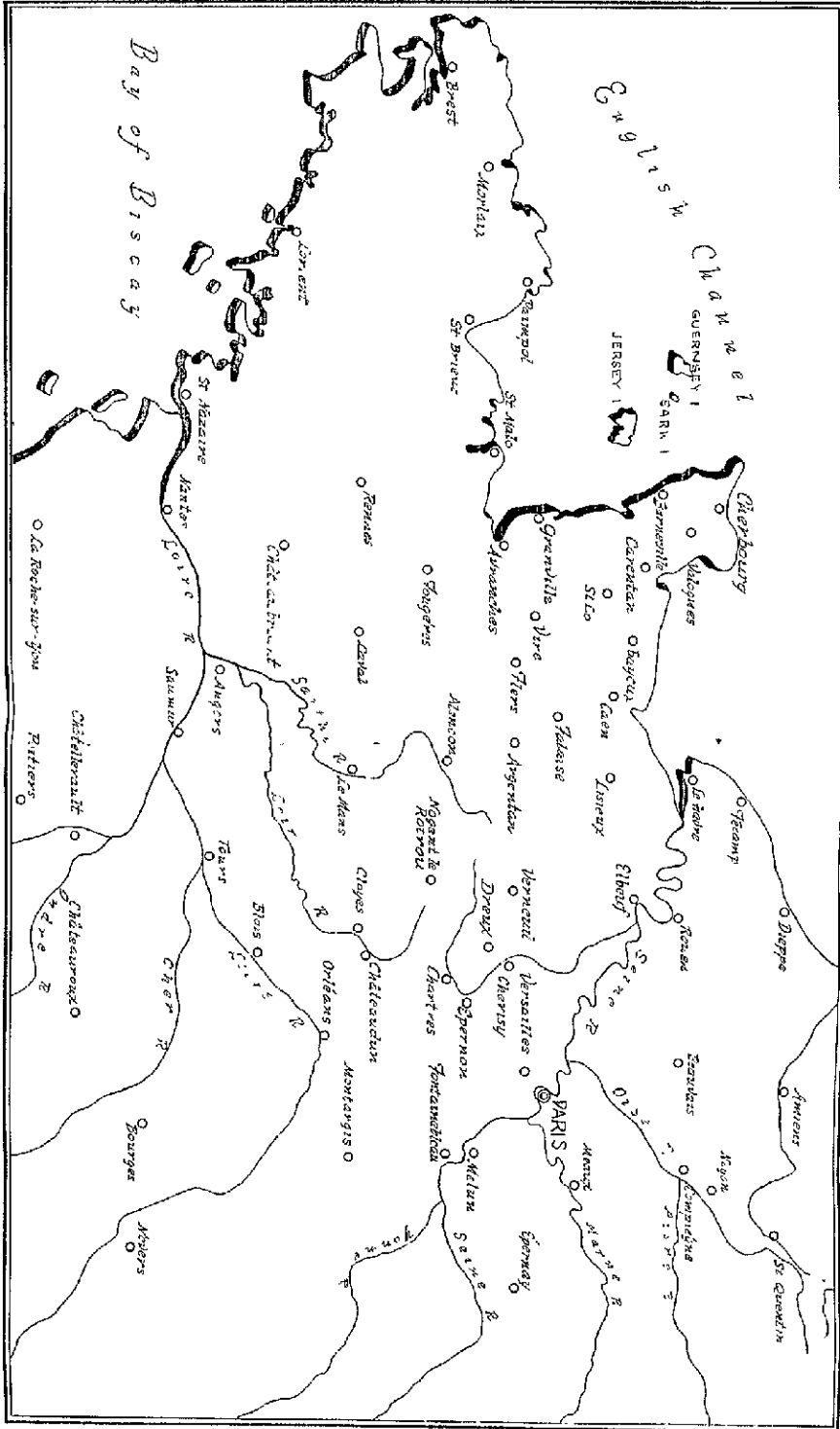

THE BATTLE AREA
 June - August 1944

DOCUMENT EXCEPTION SHEET

This page stands in-place of an object in the original document that is too large to scan into this preservation system.

Iris Number 0 467627

Description Ninth Air Force

Interdiction 1944

AO/Feb 2001/Edition 2

Auderville, 109
 Au Gay, 98, 136
Augusta (U.S.S.), 25, 54
 Aulnoye, 39
 Aunay sur Odon, 85-86, 109
 Aure River, 83
 Autainville, 163
 Autheuil, 190
 Auxerre, 206
 Avers sur Oise, 213
 Avranches, 88, 90, 93, 117, 128,
 130, 134, 153, 159-160, 168,
 171, 182, 191
 Azeville, 19

B

B-26, 90, 125, 141-142, 254,
 302, 318
 Baal, 321
 Bad Kreuznach, 272-73, 275
 Bad Kunster, 285-86
 Bagnoles de l'Orne, 114
 Balleroy, 83, 310
 Barfleur, 69, 84-85, 108
 Barneville, 82, 84
 Baron, 109
 Barsis, 218
 Basle, 248
 Battery Domaine, 229
 Battle of France, 159-60, 178,
 232
 Battle of Germany, 232
 Battle of Normandy, 97
 Bauches du Desert, 218
 Bayeux, 27, 80, 83
Bayfield (U.S.S.), 25, 54
 Bayonne, 153
 Bazoncourt, 308
 "Beagle," 190
 Beauchamps, 163
 Beaugency, 88, 206
 Beau Guillot, 70
 Beaumont, 213
 Beaumontel, 216
 Beaumont le Roger, 33, 216
 Beaumont sur Oise, 34, 234
 Beaumont sur Sarthe, 211
 Beautor, 212
 Beauvais, 34, 110, 172-73,
 176-77, 202, 218, 234
 Bedburg, 266, 268, 278
 Belgium, 31, 36, 145-46, 213,
 233, 289
 Benerville, 69, 74, 78
 Bennecourt, 43
 Beny Bocage, 117
 Bergstein, 303, 316
 Bergzabern, 320
 Berkshire, 50-51
 Bernay, 215
 Bethune, 38
 Beuzeville, 19, 71, 77
 Biblis, 298
 Biggin Hill, 51
 Billinger Wald, 321
 Bingen, 249, 256, 281, 283
 Birgel, 318
 Bitburg, 282
 Bitsch, 271
 Bizange, 310
 Blamont, 297
 Blois, 199
 Bockingen, 299
 Bois de Hommet, 96
 Boissei la Lande, 141
 Bonn, 241-43, 264, 295
 Bonnières, 189
 Borny, 310
 Boston (plane), 124
 Bouchemain, 210
 Boulay, 308
 Boulogne, 254
 Bourges, 31, 110, 178, 199, 239
 Bourheim, 314
 Bournemouth, 162
 Bourth, 88, 143, 211
 Bradley, Gen., 102
 Brancaster, 75
 Bray Court, 51
 Brecey, 166
 Brehal, 123, 133
 Breisch, 286
 Breitscheidt, 294
 Brereton, Lt. Gen. L. H., 1, 101,
 161
 Breskens, 301
 Brest, 159, 182, 194, 196, 221-24,
 229-31, 251, 254

I N D E X

A

A-2, 98, 136
 A-3, 165
 A-20, 79, 120, 141-142, 209, 254,
 282, 285, 320
 A-26, 254
 Aachen, 232, 237-38, 242, 264,
 269, 281-82, 284-85, 288,
 292-95, 297, 300-02, 304,
 316-17
 Abancourt, 79
 Abbeville, 34
 Advanced Headquarters, 9th AF,
 16-18, 28, 40, 49, 51, 60,
 62, 250, 262, 288
 Operations Order No. 168A, 69
 Aerschot, 39
 Ahrdorf, 268
 Ahrweiler, 269, 284, 286
 Air Defense of Great Britain RAF,
 24
 Air Defense Plan, 20
 Air Dispatch Letter Service, 23,
 27-28
 Airel, 79, 83, 91
 Airfields (provided for June 44),
 99
 Air Representatives, 15, 25, 54-55
 Air Support Net, 98
 Air Support Party, 25-26, 53-55,
 57, 80, 137, 180, 183, 223,
 292, 303, 309, 313
 Aisne, 197
 Aldermaston Court, 51
 Alderney Island, 62, 64, 108
 Alencon, 91, 93-95, 143, 188-89
 Allendorf, 279
 Allied Expeditionary Air Force
 (AEAF), 2, 10-11, 25, 35-36,
 40-41, 45, 80, 206
 Adv. Hq., 56, 162, 208
 Air Comdr. in Chief, 122
 Hq., 62
 Land Line Committee, 7
 Supreme Comdr., 17
 Supreme Hq., 6
 Allies, 33-34, 65, 116, 122,
 154, 159, 172, 192, 202
 Alsace, 236, 271, 274, 276,
 320
 Altenglan, 271
 Amanvillers, 244-45
 Ambrieres, 140
 Amiens, 157, 173, 176
 Ancon (U.S.S.), 25, 54, 80-81, 97
 Andaevillers, 144
 Andernach, 300
 Anderson, Brig. Gen. S. E., 69
 Andover, 50
 Angers, 144, 157, 176, 187-88,
 193, 205, 210
 Anizy le Chateau, 212
 Appelle, 216
 Appilly, 197
 "Appreciation of Scheduled
 Targets for 6 June 1944," 71
 Argentan, 78, 86, 90, 142, 160,
 169, 172, 184, 187-88,
 193-94, 197, 213-14, 217
 Arlon, 237, 248, 289-90
 Armentieres, 110
 Army List Index, 8
 Arnemuiden, 253
 Arnhem, 243, 254, 283-84
 Arnsberg, 279
 Arques, 218
 Arracourt, 246
 Arras, 39, 254
 Arry, 243
 Asch, 289
 Assault Force Omaha, 54
 Assault Force Utah, 54
 Athies, 177, 289

Breteuil, 115, 172
 Bretigny, 90, 200, 203
 Breton peninsula. See Brittany.
 Bricquebec, 84
 Brionne, 215-16
 Briouze, 90, 174, 177, 214
 Britain, 13, 21-22, 26-27, 48, 54,
 64, 78, 87, 100, 102, 120, 135,
 160-62, 169, 172, 234, 253, 301
 Brittany, 33, 153, 159-60, 188,
 203, 205, 209
 Broglie, 215
 Bronze Star, 204
 Brooks, Maj. Gen. E. H., 293
 Bruhl, 278, 295
 Brumath, 270-71
 Bruz, 114
 Buckinghamshire, 51
 Bueil, 157
 Build-up Priority Table, 8
 Bullay, 285-86
 Bups beacon, 64
 Busigny, 39

C

C-47, 17, 62, 65, 67, 171
 C-53, 17, 62, 65, 67
 Caen, 78, 109, 117, 120, 159
 Calais, 254
 Cambrai, 176, 233, 239, 289
 Camp de Bitche, 285
 Canada, 160, 172, 253
 Canisy, 128, 130, 163
 Cap Barfleur, 84
 Cap de la Hague, 107-08
 Cap Frehel, 96
 Cardonville, 19, 100
 Carentan, 19, 78-80, 83, 100,
 108, 117-19, 126
 Carrouges, 170
 Caudebec, 217
 Caumont, 135
 Cerisy, 83
 Cernay, 200
 CG-4A, 17, 62, 65-66
 Chabris, 114
 Chalgrove, 50
 Chalons, 145

Chalons sur Marne, 233
 Chambery, 177-78, 246
 Chambourg, 199
 Champagne, 234
 Chantilly, 110, 176, 233, 288
 Charleroi, 233, 239
 Charmy Down, 51
 Chartres, 34, 88, 92, 94, 110,
 113, 115, 140, 143, 145, 190,
 192, 196, 200, 202-03, 205,
 208, 210, 233-34, 288
 Chateaubriant, 94
 Chateaudun, 31, 91, 94, 161,
 163, 234
 Chateaugiron, 112
 Chateauseuf, 145
 Chateauroux, 179, 199, 239, 248
 Chateau Salins, 246, 248, 288,
 296-98
 Chatellerault, 248
 "Chattanooga Day," 44
 Chaulnes, 142
 Chauny, 207, 213, 218
 Cherbourg peninsula, 62, 69,
 78, 91, 96-97, 101, 105-08,
 223
 Cherisy, 88, 113, 140, 144, 210
 Chievres, 32, 105, 289
 Chilbolton, 23
 Cinq Mars, 139, 210
 Clairoux, 218
 Clamency, 145, 248
 Clastres, 177, 289
 Clermont, 110
 Cloyes, 88, 143, 205
 COBRA, 123
 Cognac, 178
 Colbe, 279
 Colleville, 19
 Collins, Gen., 101, 104, 318
 Colmar, 270, 274, 276
 Coltanville, 113
 Combined British American Opera-
 tions Room and Command Post,
 62
 Combined Chiefs of Staff, 2
 Combined Control Center (IX Ftr.
 Cmd. and 11 Gp. RAF), 12,
 25, 56, 70, 79-80
 Combined Control Center, 21st
 Army Gp., 57-60, 97

Combined Signal Board, Supreme Allied Command, 6
 Mutual Interference Subcommittee, 7
 Commanding General, 9th AF, 9, 20, 52, 54, 55
 Command Post Exercise, 53
 Compiègne, 159, 173, 213, 218
 Conches, 96
 Conde sur Noireau, 85, 91, 109, 214
 Conde sur Vire, 114
 Conflans, 42-43, 87, 138, 207
 Coningham, Air Marshal, 102
 Controllers, 15, 24-25, 54
 Corbeil, 217-18
 Corbie, 211
 Corlett, Maj. Gen. C. H., 118
 Corneilles en Vexin, 32-33, 234
 COSSAC, 2
 COSSAC Appreciation of Operation Overlord (15 July 1943), 2
 Cotentin peninsula, 82, 84, 97, 117, 119, 161
 Coulommieres, 146, 234
 Courcelles, 43, 138
 Courpeville, 71, 77
 Courtalein, 211
 Courtrai, 32
 Coutances, 79, 85, 90, 92, 125, 128-30, 163
 Coutouvrey, 163
 Couvron, 289
 Coxyde, 32
 Creances, 119
 Creil, 38, 115, 203
 Creil St. Maximin, 213
 Crepy en Valois, 197
 Criqueville, 18-19, 98
 Crisbecq, 84
 CROSSBOW, 30
 Crozon, 222, 231, 254
 Custines, 252

D

Daun, 271
 D-day, 11, 14, 16, 18, 29, 34-36, 40, 42-43, 48, 56, 61, 65, 69, 76-77, 80, 82, 86, 95, 99, 103

Demouville, 120
 Denain, 34
 Derichsweiler, 318
 Deux Jumeaux, 19
 Devon, 62
 Devonshire, 50
 Dieuze, 248, 297-98, 320
 Digulleville, 108
 Dijon, 178, 239
 Dillenburg, 267, 269
 Dillengen, 285
 Dol, 111
 Domfront, 95, 170, 176-77, 196
 Dompaire, 245
 Dorset, 50
 Doullens, 212, 218
 Dreux, 177, 189, 191, 194, 205, 234
 Drucat, 34
 Ducey, 128
 Dumpelfeld, 266, 278
 Dunkirk, 45, 254
 Duren, 242, 266, 268, 278, 281, 285, 295, 303, 305-07, 317
 Durwiss, 317-18
 Dusseldorf, 243, 257, 279, 306-07

E

8th Air Force, 28, 31, 77, 123, 128, 176, 317
 CG, 317
 VIII Corps, 223
 VIII Ftr. Comd., 14, 70, 124
 11 Gp. RAF, 10, 56
 "11 Group and IX Fighter Command Joint Air Plan and Executive Order," 10, 13, 64
 Annex No. 9, 13
 80th Inf. Div., 245, 309
 82d U.S. Airborne Div., 10, 17, 61, 66-67
 83d Inf. Div., 221
 84th Corps, 121
 84th Ftr. Wing, 290
 85 Gp. RAF, 15, 20, 26
 Eastcote, 51, 62
 Echternach, 253, 278
 Lehtz, 318

Economic Objectives Unit, 152
 Economic Warfare Div., 152
 Ecouche, 78
 Ehrang, 282
 Eisenhower, Gen., 30
 Elbeuf, 43, 174
 Eller, 285
 Elsassthal, 269
 Elsdorf, 318
 Elster, Gen. 247
 Embassy, U.S., 152
 England, 17, 96, 100, 233
 English Channel, 14, 21, 25, 50,
 62, 162
 Eperney, 202
 Epernon, 88, 113, 140, 210
 Epinal, 245, 248
 Epone-Mezieres, 210
 Erbenheim, 250
 Erberich, 315
 Erkelenz, 264, 278
 Erp, 319
 Eschweiler, 264, 281, 300,
 304-06, 317
 Essex, 50-51, 138, 162, 223
 Etain, 233
 Etampes, 185
 Etang de Lindre, 298
 Etaples, 46, 206
 Etienneville, 71
 Eupen, 242
 Eure, 190
 Euskirchen, 241, 264-66, 268-69,
 273, 281-82, 284, 286, 306
 Evreux, 33, 38, 88, 94, 110,
 142, 190, 217
 Exercise EAGLE, 68

F

1st British Airborne Div., 10,
 17, 254
 1st Tactical Air Force, 236
 1st U. S. Army (FUSA), 2, 6, 8,
 25, 29, 55, 57, 60, 97, 102,
 116, 119, 129, 134, 136-37,
 160, 163, 165, 167, 170, 237,
 339, 281, 283, 290-91, 294,
 297, 300, 306, 312, 316

Adv. Hq., 163
 CG, 55
 Hq., 98, 179
 1st U. S. Army Gp., 1-2, 6, 8,
 12, 26, 29
 1st U. S. Inf. Div., 25, 54, 293
 4th Armored Div., 190, 246, 252
 4th U. S. Inf. Div., 25, 54, 127
 5th Armored Div., 285
 5th Inf. Div., 185, 188, 190,
 244, 302
 5th Ranger Bn., 223
 V U. S. Corps, 25, 54, 70, 83,
 293, 302, 304
 CG, 293, 304
 XV Corps, 245
 47th Regt., 127
 48th FB Gp., 238, 240-42, 280,
 291, 293, 300, 313
 50th FB Gp., 175, 236-38, 241-42
 404th FB Gp., 167, 237, 242-43,
 264-65, 277, 279, 291, 293-94
 297, 300, 313, 315
 405th FB Gp., 133, 182, 194,
 196-98, 202, 241, 244, 246,
 248-49, 270, 274-77, 291, 297,
 308-09, 311
 406th FB Gp., 181, 191, 197-201,
 224, 245, 248-50, 271-72, 275,
 291, 297-98, 308, 310
 422d Night Ftr. Sq., 307
 474th FB Gp., 177, 179, 238, 240,
 242, 264, 289, 291-92, 295,
 303-04
 Falaise, 78, 120, 169, 172, 174,
 188, 214
 Falkenberg, 310, 320
 Fauville, 33
 Fay, 112
 Fermanville, 108
 Field Service Regulations 100-20,
 30, 35
 Fighter Control Center, IX TAC, 26
 Fismes, 206, 212
 Flers, 90-91, 170, 214
 Florennes, 233, 289
 Folligny, 90-91
 Fontainebleau, 183, 190
 Fontenay, 80
 Forbach, 274, 288

Force "O", 80
 Foret d' Andaine, 95-96, 114, 177, 217
 Foret de Blois, 218
 Foret de Bretonne, 177
 Foret de Cerisy, 34
 Foret de Chantilly, 218
 Foret de Coevran, 177
 Foret de Conches, 114, 156
 Foret d' Ecouvres, 95, 114, 156, 177
 Foret de Grimbosq, 95
 Foret de la Guerche, 156
 Foret de la Leye, 252
 Foret de L'Aigue, 218
 Foret de la Lande, 216
 Foret de l'Isle Adam, 218
 Foret de Marchenoire, 163
 Foret de Montrichard, 218
 Foret de Parroy, 252, 297
 Foret de Ferseigne, 188, 217
 Foret de Rambouillet, 177
 Foret de Roumare, 217
 Foret de Samoussy, 218
 Foret de Senonches, 114, 156, 177
 Foret de Sille, 217, 219
 Foret d' Halcuzc, 219
 Foret du Chateau Salins, 309
 Forges, 142
 Fort Central, 107
 Fort Orient, 290, 302
 Fort du Roule, 100
 "Fortress Lrest," 222
 Fort Toubroch, 228
 Fougères, 91, 185
 Foulbec, 216
 Fournival, 218
 France, 21, 29, 31-32, 36, 40, 44-45, 47-48, 95, 161, 193, 236, 246-47, 263
 Frankfurt, 241, 250, 273, 275, 301
 French Forces of the Interior, 248
 Fresnes en Saulnois, 246, 297
 Frevent, 212
 Friqueville, 31
 Furnes, 32
 FW-190, 76, 242, 249, 294-95, 307, 312

G

G-2 Air, 98, 162
 G-2 (FUSA), 98
 G-3 Air, 98, 136, 162, 175, 231, 215
 Gatteville, 78
 Gavray, 125, 128, 133
 Gee equipment, 63-64
 Gefosse, 70, 77
 Geilenkirchen, 238, 241, 285
 Geislingen, 261
 Gemund, 238, 302, 321
 Gemunden, 276
 General Commander in Chief of the Allied Armies in France, 122
 Ger, 169
 Gereonsweiler, 315
 German Air Force (GAF), 30, 48, 77, 165, 177, 200-02, 237, 239, 249, 294-95, 298, 312, 315
 German Army, 172
 Germersheim, 250, 257
 Gerolstein, 278, 282
 Gertruidenberg, 284
 Gestapo, 179
 Gey, 305, 318
 Giberville, 120
 Gien, 159, 195, 198
 Giessen, 241, 319, 321
 Gisors, 110
 Gondrexange, 311
 Grandcamp les Bains, 162
 Grankenburg, 279
 Grantham, 51
 Granville, 90, 93, 108, 110, 128-29, 131, 163, 220
 "Green System," 267
 Grevenbroich, 279-80, 284
 Groome, Air Vice Marshal, 102
 Grosley sur Risle, 141
 Gross Ostheim, 301
 Grove, 23
 Guernsey Island, 62, 64
 Gurzenich, 318

H

Hagenau, 270-72, 274, 320

Haleine, 163
 Hall, 311
 Ham, 206, 218
 Hamm, 261
 Hempont, 310
 Hampshire, 50-51
 Hanau, 241
 Hanfscheld, 303
 Haraucourt, 246
 Hargarten, 276
 Hasselt, 41
 Hastenrath, 305
 Hezebrouck, 110
 Headquarters, 9th AF, 4, 10, 24,
 27, 51-52, 97-98, 105, 135-36,
 143-44, 157, 162, 164, 208,
 259, 288. See also Advanced
 Headquarters.
 Hebecrevon, 124
 Heeronthals, 41
 Hehlrath, 317
 Heidelberg, 274, 277
 Heistern, 305, 307
 Hengelo, 284
Henrico (U.S.S.), 25, 54
 Herbach, 301
 Hermeskeil, 272, 274-75
 Herpy, 172, 178
 Hessian, 100
 Hill 89, 228
 Hill 90, 229
 Hill 100, 229
 Hillingdon House, 56, 59-60
 Hirson, 40
 Hochspeyer, 274
 Holland, 31, 33, 152, 283, 291
 Homburg, 270, 320
 Horrem, 279
 Horsa glider, 17, 66
 Houdan, 172
 Houlgate, 78, 109
 Hurtgen, 238, 302, 304, 306

I

Ihrlich, 287
 Ile de Coezembre, 174, 203, 220
 Ilioc, 229
 Illus, 41
 Immendorf, 300

Inde, 306
 "Information in Log," 59
 Ingweiler, 274
 Initial Joint Plan, 3-5
 Intelligence Section, 71
 Interdiction Program, 44
 as of 9 Aug. 44, 207
 as of 14 Sep. 44, 257
 as of 8 Oct. 44, 259
 "Ironclad," 245
 Isigny, 79, 86
 Issel, 262
 Issoudun, 199

J

Jager, 124
 Jallaucourt, 246, 297
 Jamioulx, 233
 Joigny, 194, 198, 212
 Joint Air Force, 15
 Joint Fire Plan, 69
 Joint Signal Board, 21st Army
 Gp., 6
 Radar and VHF Siting Sub-
 committee, 7
 Joint Wire Gp., 1st U.S. Army
 Gp., 29
 JU-52, 178
 JU-88, 198
 Julich, 264, 266, 279-82,
 285, 305, 315, 317
 Jurques, 84, 109
 Jussy, 212
 Juvigny, 170
 Juvincourt, 172, 177, 234

K

Kaiserslautern, 271, 273-75,
 286
 Kaltenhausen, 274
 Karlsheim, 311
 Karlsruhe, 249, 256-57
 Karlstadt, 273
 Kassel, 280
 Kent, 50-51
 Kergonant, 228
 Kerviniou, 224

Kirn, 275
 Koblenz, 240, 257, 265-66,
 271-73, 276, 279, 285, 295,
 300
 Kochern, 270
 Koenigsmacker, 309
 Koln, 241-42, 257, 262, 264, 266,
 268, 279, 306, 316
 Kons Kerthaus, 285-86
 Koslar, 314
 Kriechingen, 274
 Kyllburg, 278

I

Laasphe, 279
 La Barberie, 119
 La Bel es Martins, 108
 La Buisson, 217
 La Cambe, 19
 La Chapelle, 124
 La Chenale, 211
 La Croisille, 142, 211
 La Ferriere, 216
 La Ferte, 169
 La Ferte Mace, 214
 La Ferte St. Aubin, 112
 La Frilliere, 139
 La Haye du Puits, 79, 84, 90-91,
 109, 117, 119, 121
 La Heuniere, 189
 La Hutte Coloumbieres, 143, 205
 Laigle, 93-94, 141, 211
 La Loupe, 96, 110, 144
 La Madeleine, 70
 Lamballe, 196
 La Mere es Conards, 107
 La Moriniere, 119
 Lancaster (plane), 174
 Landau, 249, 275, 298, 320
 Landstuhl, 271
 Laneuveville en Saulnois, 246
 Langerwehe, 301
 Laon, 110, 159, 177-78, 197, 218,
 289
 La Pernelle, 84, 108
 La Poissoniere, 139, 150
 La Rabellerie, 216
 La Sangsurriere, 71
 Launay, 216
 Lauterburg, 276
 Lauterecken, 271
 Laval, 90, 92, 141, 163, 185,
 205
 Laye, 108
 Lebach, 277
 Le Bourg, 216
 Le Culot, 299
 Le Havre, 254
 Leidenborn, 238
 Leigh-Mallory, Sir T., 122
 Le Lude, 217-18
 Le Manoir, 42, 138, 194
 Le Mans, 90, 94, 143, 146, 161,
 183, 185, 191, 211
 Le Mesnil, 42
 Le Molay, 91
 Lemoncourt, 297
 Les Andelys, 173
 Les Chenes Secs, 163
 Les Dunes de Varreville, 70
 Les Foulons, 212
 Les Cubeaux, 136
 Les Ponts du Ce, 139, 150, 210
 Lessay, 86, 92, 109, 119, 123,
 163
 Le Tremblay le Vicomte, 173
 Liege, 41, 48
 Limburg, 237, 249-50, 267, 319
 Lincolnshire, 50-51, 62
 Linnich, 301
 Liocourt, 309
 Lippstadt, 279
 Lisieux, 214-15
 L'Isle Adam, 213
 Lisons, 91
 Lissendorf, 264, 271
 Littry, 84
 Loches, 199
 Lohr, 274
 Loire River, 44, 48, 87-88, 94,
 138-40, 144, 150, 152-54,
 159-60, 164, 177, 179, 193,
 195, 198, 205-06, 211, 239,
 247-48, 287
 London, 2, 51
 Longpre les Corps Saints, 79
 Lorient, 159, 194, 196, 254
 Louviers, 145
 Loverich, 315
 Luchem, 318

Ludwigshafen, 257
 Luftwaffe, 122, 241, 250
 Luxembourg, 243, 271, 273, 282,
 288, 297, 310

M

Maastricht, 232, 237, 241, 289,
 291
 Mahon, 41
 Maintenon, 88, 140, 177, 201, 205,
 210, 217
 Mainz, 250, 257, 274
 "Mairzie Doats," 184
 Maisons Lafitte, 42-43, 113
 Maisy, 80, 84
 Maisy I, 69, 74
 Maisy II, 70, 77
 Maisieres les Metz, 245
 Mallaucourt, 246
 Mallaucourt sur Seille, 297
 Mamers, 146
 Mantos, 189
 Mantos-Gassicourt, 39-40, 42, 88,
 112-13, 133, 145, 172, 183, 189,
 201, 205, 209
 Marauder, 124
 Marburg, 267
 Mariaweiler, 318
 Marigny, 127-28, 135
 Marks Hall, 51
 Marne River, 159, 275
 Marolles, 187
 Marseilles en Beauvaisis, 218
 Meyen, 241, 271, 285-86
 Mayenne, 91, 200
 ME-109, 191, 200, 242-43, 294-95, 312
 ME-190, 294-95, 312
 ME-262, 294
 Meaux, 194
 Mechernich, 269
 Mohun, 193
 Melun, 185, 196
 Membury, 23
 Merchede, 279
 Merchingen, 309
 Meroy, 211
 Merken, 318
 Merlerault, 93

Merode, 318
 Merton, 47
 Merville les Vie, 308
 Merzig, 277, 310, 316, 319
 Messac, 88
 Mestry, 19
 Metz, 232, 238, 243-45, 248,
 250, 252, 273, 283, 285, 288,
 296-97, 302, 308-10
 Meulan, 43
 Meuse River, 40-41, 159
 Mezidon, 91, 110
 Mezieres, 39, 41, 245, 248
 Middlekirk, 32
 Middlesex, 51
 Middle Wallop, 50-51
 Mirville, 141, 208
 Modrath, 268
 Moerdijk, 284
 Moisson, 189
 Molsheim, 311
 Mons, 39, 239
 Montargis, 195, 198
 Montebourg, 84
 Montereau, 185
 Montfarville, 69, 74, 84
 Montfort, 145
 Montgomery, Sir B. L., 122
 Montreuil, 84, 124
 Lontrichard, 199
 Mont Secret, 90
 Morshoid, 286
 Mortagne au Perche, 205
 Mortain, 160, 166, 168, 170, 187
 Moselle River, 232, 243, 245,
 251-52, 262, 266, 297
 Mulhausen, 270
 "Murphy," 166, 168-69, 187
 Nutzig, 272

N

9th AF Operations Center, 162
 IX Air Defense Comd., 4, 20, 28
 Hq., 51
 9th Air Force Photographic Gp.,
 48
 IX Air Force Service Comd. (AFSC),
 4, 20-23, 28, 129, 235
 Hq., 51

9th Bomb Div., 236, 251-55, 281,
 283-84, 286, 289, 301-02, 316
 Hq., 288, 317, 319
 IX Bomber Comd., 4, 16-18, 24,
 37, 45, 48, 50, 53, 69, 75,
 78, 85, 89, 92, 103, 114, 116,
 119-21, 124, 135, 138-39,
 141-42, 145, 150, 155, 162,
 174, 205, 208, 211, 213-14,
 216-17, 219, 221-22, 224-25,
 230, 233-34, 236
 CG, 52
 Hq., 16
 Targets for 6 June 1944, 71
 IX Ingr. Comd., 4, 18-19, 28,
 97, 99-100
 Hq., 28, 51
 IX Ftr. Comd., 4, 10, 12, 69-70,
 76, 83, 110, 116, 118, 144-45,
 157
 Adv. Hq., 56
 CG, 52
 Hq., 51
 Targets for 6 June 44, 73
 9th Inf. Div., 127, 301
 9th SS Panzer Div., 152
 IX Tactical Air Comd. (TAC), 10,
 12-15, 20, 24, 50, 53-54, 56,
 60, 70, 76, 98, 100-01, 110,
 116-18, 122, 125, 128, 150,
 152, 134-37, 143-44, 157, 160,
 162, 164, 167, 169-71, 173-74,
 176-78, 180, 191-92, 221, 223,, 233,
 237-41, 243, 247-48, 256-58,
 264-68, 277, 280, 288-96, 302,
 305-07
 Adv. Hq., 15, 25, 29, 60
 G.O. No. 158, 98
 Hq., 28, 51, 98, 163
 IX Troop Carrier Comd., 4, 10,
 14, 17, 29, 47-48, 50, 61-62,
 65, 67, 76, 171, 236
 CG, 52
 Field Order No. 1, 61
 Hq., 51
 IX Troop Carrier Command Path-
 finder School, 63, 65, 67
 9th U. S. Army, 247
 XIX Corps, 118, 168, 187, 193,
 292-93, 300-01
 CG, 118
 XIX TAC Combat Operations, 187
 XIX Tactical Air Comd., 12, 16,
 20, 24, 28, 53, 56, 70, 76,
 160, 162-63, 180-82, 186,
 192, 194-95, 198-99, 202-04,
 223, 233-34, 243, 247-50,
 256-58, 269, 271, 276, 280,
 289, 291, 296, 299, 304, 308,
 310-12
 Adv. Hq., 289
 CG, 248
 Hq., 51
 XIX Troop Carrier Comd., 24
 90th U. S. Inf. Div., 172,
 244-45
 91st Inf. Div. (German), 66
 97th Wing, 234
 98th Bomb Wing, 162, 234, 289
 99th Wing, 234
 Namur, 39, 41
 Nancy, 232, 245-46, 248, 251-52,
 289, 296, 309
 Nantes, 48, 139, 144, 150, 159,
 187, 196, 199, 206, 210, 218
 Nanteuil, 206, 212
 Nerbonne, 153
 Nesselndres, 216
 Naval Dispatch Boat Service, 28
 Navy, 5, 26, 49
 Neder Rijn, 254, 283
 Nehou, 71
 NEPTUNE, 5-6, 24, 29-30, 61
 Netherlands, 240
 Neuenberg, 286
 Neufchâteau, 195, 198, 202
 Neunkirchen, 271, 277
 Neustadt, 273
 Neury, 206
 Neury sur Loire, 211
 Newried, 287
 Nevers, 176, 199
 Niergnies, 289
 Ninth Air Force Planning Gp., 4-5
 "Ninth Air Force Plan of Opera-
 tion 'Neptune'--Tactical Air
 Plan," 1, 11, 61
 sections of, 11-12
 Ninth Air Force Tactical Air Plan,
 5, 8, 10-12, 21, 30, 97
 Annex 5, 8, 23
 Nogent, 146, 194, 206
 Nogent le Roi, 88, 140, 145, 210
 Nogent le Rotrou, 94, 194
 Nogent sur Loire, 211
 Nogent sur Seine, 211-12

Nohfelden, 270
 Normandy, 42, 122, 150, 160-61,
 172, 233
 Norman pocket, 160
 Northampton, 50
 Northolt, 28
 Norvenich, 268
 Notre Dame de Courson, 215
 Noyen, 197
 Noyon, 197
 Nugent, Frig. Gen. R. E., 290

O

101st U. S. Airborne Div., 10,
 17, 61, 66-67, 76
 104th Inf. Div., 307
 116th Inf. Regt., 228
 120th Inf. Regt., 171
 Ober Olm, 301
 Ober Roden, 276
 OECE, 208
 Octeville, 104
 Oise, 197, 207, 213
 Oiseme, 88
 Oise-Sambre Interdiction Line,
 207, 212
 Oissel, 40-42, 79, 92, 113, 138,
 174, 209
 Old Sarum, 53
 Omaha beach, 18, 23, 25, 69,
 82-84
 Operational Research Section, 75
 "Operation Market," 240
 Crival, 40, 42
 Orleans, 31, 48, 87, 110, 157,
 176, 234
 Orne, 169
 Ostend, 32, 254
 Ostheim, 241
 Ottweiler, 271
 Cuistrehem, 69, 74
 OVEERLORD, 36
 Oxfordshire, 50

P

P-38, 14, 102, 124, 175, 240,
 242, 268, 294-95

P-47, 13, 102, 132, 167, 171,
 184, 228-29, 242-43, 293, 295,
 307
 P-51, 102, 124, 184, 187, 249-50,
 299
 P-61, 307
 Pacy sur Eure, 189-90
 Paderborn, 268
 Pagny, 244
 Palmpol, 188
 Panzer, 95
 Paris, 41-43, 48, 91-92, 94-95,
 145, 152, 159-61, 176-77, 183,
 195-98, 201-03, 206-07, 211,
 213, 217-18, 233-34
 Paris-Orleans gap, 88, 92, 112,
 140, 144, 206, 210
 Pas de Calais, 45, 47
 Patton, Gen., 180, 195, 204, 319
 Peltre, 308
 Penfeld River, 225
 Percy, 128, 133
 Perriers, 86, 117, 119, 123-24,
 128, 157
 Peronne, 115, 178, 197, 206,
 212, 239, 289
 Pfaffenhofen, 274
 Pfalzel, 286
 Pfeddersheim, 275
 Photo Reconnaissance, 49
 Piceuville, 19
 Pier, 319
 Firmasens, 274, 311
 Planning Syndicate, 5
 subjects covered by, 4
 Plans Section, 9th AF, 9-11
 D/CS, 2
 Signal Communications Officer, 5
 Ploermel, 94
 Plonagot, 182
 Plymouth, 25
 Pointe d'Espagnols, 224
 Pointe du Grouin, 96
 Pointe du Hoc, 69, 74
 Poissy, 43
 Poitiers, 176, 248
 Poix, 19, 32
 Polish Armored Div., 172
 Pompey, 252
 Pont a Mousson, 232, 245, 249,
 252, 296-97

Fontaubault, 92, 128
 Port Audemer, 215-16
 Font Authou, 216
 Pont de l'Arche, 43
 Pont l'Eveque, 214
 Fontoise, 213
 Fontorson, 91, 157
 "Poodle," 160, 188
 Pouppeville, 100
 Primary Interdiction Project, 206
 Pronsfeld, 282
 Frouvy, 34
 Prun, 282
 Futtelange, 288
 Putzlohn, 317

Q

Quartermaster
 Truck Regt. Hq., 23
 9th AF truck companies, 99
 Quebec Trident Conference, 2
 QUEEN, 304, 312, 317
 Querrieu, 218
 Quesada, Maj. Gen. E. R., 70,
 101, 128
 Quibehou, 131
 Quilly le Vicomte, 215
 Quineville, 84

R

RAF, 24, 48, 64, 77, 317
 RAF Bomber Comd., 174
 RAF School of Army Cooperation,
 53
 Rangiport, 43
 Rastatt, 256-57, 276, 311-12,
 319
 Rech, 278
 Red Cross, 173
 Redon, 187
 "Red System," 267
 Reichenbach, 266
 Reims, 159, 172, 176, 179, 195,
 197, 208, 233-34, 288-89
 Remagen, 257, 266, 268, 278
 Rennes, 31, 88, 90-91, 94, 111,
 156-57, 161, 176, 182
 Rethel, 201

Rheinbach, 278, 320
 Rheydt, 266, 278
 Rhineland, 44
 Rhine River, 240, 248, 256-57,
 261-62, 266-67, 269, 271-81,
 283, 285-86, 304, 311, 319, 321
 Risle River, 214-15
 Roermond, 266, 284
 Roer River, 288, 303-04, 306,
 313, 315-16
 Rosieres, 178
 Rosieres en Maye, 289
 Rotenburg, 268
 Rotgen, 238
 Rouen, 38, 41-43, 87, 138, 172,
 206, 214, 217
 Royal Navy Fleet Air Arm, 10
 Roye Amy, 178, 234
 Rugles, 215
 Ruhrburg, 303
 Rumania, 152
 Rutland, 50

St., Ste.

St. Amend, 239
 St. Andre de l'Eure, 115
 St. Avoird, 308
 St. Parthelemy, 166
 St. Cyr., 176
 St. Die, 270, 272
 St. Dizier, 159, 235
 Lte. Gauburge, 205
 St. Florentin, 191
 St. Germain, 42-43
 St. Germain sur Ay, 117
 St. Gildes des Bois, 188
 St. Gilles, 124-25, 128
 St. Goar, 276
 St. Hilaire, 111
 St. Hilaire du Harcourt, 140
 St. Honore, 138
 St. James, 163
 St. John's Hood, 51
 St. Laurent, 100
 St. Lo, 79, 84-85, 90, 108,
 117, 119-20, 123-24, 128,
 130, 135, 157, 159-60
 St. Lubin, 93
 St. Malo, 174, 196, 203, 219-20
 St. Martin des Pesaces, 84

St. Martin de Varreville, 70, 76
 Ste. Mere Eglise, 19, 61, 66, 71
 St. Mazeire, 159, 254
 St. Pierre du Mont, 18-19
 St. Pierre du Teuvrey, 43
 St. Pierre Eglise, 96
 St. Quentin, 110, 176-77, 233,
 290
 St. Remy, 296
 St. Remy du Plain, 188
 St. Remy sur Avre, 88, 140
 St. Sauveur de Pierre Font, 71,
 77
 St. Sauveur Lendelin, 162
 St. Sauveur le Vicomte, 71, 84-86,
 91, 109, 119
 St. Servan, 219
 St. Sever, 114
 St. Trond, 289
 St. Wendel, 283

S

2d Advanced Air Depot Area, 23
 2d Armored Div., 166, 180, 237
 2d Bn. (120th Inf.), 171
 2d Inf. Div., 170, 229
 2d Paratroop Div., 150
 2d Tactical Air Force RAF, 2,
 5-6, 27-28, 45, 56, 102, 169,
 259
 Eq., 28
 6th Army Gp., 236
 6th U. S. Army, 297
 7th Armored Div., 185, 190
 7th German Army, 151
 7th U. S. Army, 178, 236, 248,
 320
 VII U. S. Corps, 25, 54, 70,
 84-85, 101, 170, 253, 292, 318
 CG, 518
 Eq., 100
 16th GAF Div., 152
 17th SS Panzer Grenadier Div.,
 309
 67th Tac. Ren. Gp., 307
 70th Ftr. Wing, 15, 98
 79th Inf. Div., 101, 191, 252,
 297

S-2, 53, 59
 S-3, 53, 59
 Saar, 274-75, 277, 319
 Saarlben, 298
 Saarbrucken, 248-49, 271, 276,
 283, 312
 Saarburg, 270-71, 273
 Saargemund, 270-71, 274, 276
 Saarguemines, 311
 Saarlautern, 271
 Saarunion, 274
 Saarwellingen, 310
 Sable sur Sille, 94
 Sachsenheim, 276, 299
 Saumur, 139, 176, 199
 Scheid, 253, 264
 Scheldt estuary, 253, 301
 Schlettstedt, 272, 274, 311
 Schlich, 318
 Schlichtigheim, 276
 Schmidt, 302-03
 Schwabisch, 311
 Scorton, 61
 SCR-522, 129
 SCR-584, 240
 SCR-717-C radar, 63-64
 Second Bridge Interdiction Line,
 206-07
 Sedan, 41
 Sees, 188
 Segre, 110, 145
 Seille River, 288, 296, 298
 Seine-Loire gap, 88, 159-160,
 172-74, 189-90, 194-95, 206,
 209, 211, 214, 216, 287
 Seine River, 40-42, 45, 47-48,
 78, 87-88, 92, 94, 114, 138,
 140, 144-45, 152-54, 159-60,
 164, 172-74, 189-90, 194-95,
 206, 209, 211, 214, 216, 287
 rail interdiction program for,
 89
 "Seine River Area," 172-73
 Seligenstadt, 241
 Semecourt, 245
 Senior Air Representative,
 80-81, 97
 Sers, 157, 159, 190, 192
 Sergy, 141
 Serqueux, 79

Services of Supply, ETO, 2
 SHAEF, 222
 Sherman, 131
 Siegfried Line, 232, 242, 253, 256,
 262, 288, 316, 320
 Sienna, 118
 Siersdorf, 315
 Sigmaringen, 279
 Signal Communications Section,
 5-6, 23
 Signal Coordination Board, 7
 Signal Plan, 9th AF, 5, 7-8, 27,
 29
 Signal Plans Section, 6
 Planning Sub-section, 5
 Simmern, 271, 275
 Simpson, Lt. Gen. W. H., 314
 Sinzig, 285, 287
 Soest, 279
 Soissons, 172, 176, 195, 197
 Somerset, 50
 Somme River, 47, 218
 Sotenich, 264-65
 Sottevest, 91
 Sourdeval, 167, 170
 Souvigny, 141
 Spaatz, Gen., 102
 Speyer, 250, 257, 275
 Staufenburg, 279
 Stirling plane, 64
 Stockheim, 319
 Stolberg, 238, 304
 Strasbourg, 248, 256-57, 276, 312
 Stuttgart, 274
 Sunninghill Park, 51-53, 233
 Supreme Allied Commander, 36

T

3d Armored Div., 165-67, 171,
 237
 3d U. S. Army (TUSA), 12, 160,
 172, 178, 180-81, 193, 195-96,
 198-99, 204-05, 223, 243, 247-48,
 252-53, 288, 296-97, 319-20
 Adv. H., 163
 CG, 204, 319
 Hq., 163
 10th Photo Ren. Gp., 18
 10th SS Panzer Div., 152

12th Air Force, 236
 XII Corps, 245-46, 249, 298,
 308
 XII Tactical Air Comd., 236,
 258
 12th U. S. Army Gp., 160, 175,
 205, 231, 233, 251, 256, 258,
 262, 288-90, 316-17
 Adv. Hq., 162
 Hq., 162-64
 XX Corps, 243-46, 275, 308, 321
 21st Army Group Airborne Troops,
 10
 21st Army Group (British), 2,
 5-6, 55, 69, 74, 119-20
 CG, 3, 86
 Combined Control Center,
 57-60
 Hq., 5
 23d Inf. Regt., 229
 26th Inf. Div., 285
 28th Inf. Div., 302
 29th Inf. Div., 228, 231
 XXIX Tactical Air Comd., 258,
 278-80, 289-91, 299, 312-13,
 316
 30th Inf. Div., 125, 127
 35th Inf. Div., 309
 36th FB Gp., 188, 192-94,
 196-97, 243, 245-46, 248,
 250, 279-80, 290-91
 38th Inf. Div., 229
 268th Inf. Div., 150, 153
 275th Inf. Div., 149
 276th Inf. Div., 153
 303d Ftr. Wing, 187, 290
 307th Gp., 304
 343d Inf. Div., 150
 352d Inf. Div., 122
 353d Inf. Div., 153
 354th FB Gp., 188, 200-02,
 249-50, 272-73, 275, 277,
 291, 299, 311-12
 355th FB Gp., 289
 356th FB Gp., 182, 184-85,
 187-89, 192, 196-97, 201, 224,
 274, 276, 278-79, 291, 296-99,
 309, 311-12
 362d FB Gp., 181, 187, 189-91,
 194, 196, 199-201, 224, 249,
 271-76, 289, 291, 296-97, 308,
 310-12

Vigny, 312
 Villedieu, 93, 109, 128-29, 131,
 133, 153
 Villefranche, 199
 Villeneuve, 191
 Ville sur Ilion, 246
 Vire, 69-70, 90, 93-94, 96, 118,
 122, 153, 166
 Vitre, 111, 157
 Vitry, 112
 Vitre le Francois, 234
 von Kluge, Field Marshal, 151,
 179
 von Rundstedt, Field Marshal, 95
 Vossenach, 303
 Vouziers, 197
 Voves, 88

W

Waco glider, 17
 Wahn, 241
 Walcheren Island, 254, 284
 "War Diary of the 7th German Army,"
 94, 121, 126, 149-150
 Warspite (U. S.), 174
 Wehrmacht, 156, 194, 247
 Weisbaden, 250, 273
 Weisweiler, 318
 Wengerochr, 265-66, 271
 West, Gen., 151
 Western Naval Task Force, 25-26,
 54
 Naval Comdr., 55

West Wall, 251
 Wevelghem, 32
 Weyland, Brig. Gen. O. P.,
 180, 193, 204, 247
 Whitechurch, 28
 Williams, Brig. Gen. P. L., 61
 Wiltshire, 50-51
 Wire Committee, 1st U. S. Army
 Gp., 7
 Wittlich, 321
 Wittringen, 277, 311
 Worms, 273
 Wullmenroth, 267
 Wurzburg, 273

Y

Y-Intercept, 26, 294
 Yorkshire, 51

Z

Zabern, 270, 320
 Zellhausen, 311
 Zuid Beveland, 253
 Zulpich, 266
 Zweibrucken, 253, 270-71, 312,
 321

363d FB Gp., 181-82, 192, 194,
 200, 237
 363d Tac. Ren. Gp., 290-91
 365th Ftr. Gp. (FB), 83, 150, 178,
 242-43, 264, 291, 294-95, 303, 305,
 307
 366th Ftr. Gp. (FB), 83, 119, 166,
 169, 237, 240, 278-79, 289-91,
 305-06
 367th FB Gp., 173, 178, 238, 240-43,
 274-75, 291, 294-95, 304, 307
 368th Ftr. Gp. (FB), 83, 165-67,
 169, 237-39, 242, 264, 289, 291,
 293, 295
 370th FB Gp., 174-75, 178, 241-42,
 289, 291-92, 295, 303
 371st FB Gp., 187-91, 193, 199,
 203, 236, 243, 249
 373d FB Gp., 182, 188, 196-200,
 245, 248, 278, 291, 300-01, 315
 378th FB Gp., 278
 379th FB Gp., 177
 Tactical Air Force, 1, 161
 Tactical Reconnaissance Group, 47
 Tergnies, 178
 Tessy, 153, 181
 Tessy sur Vire, 128
 Thibouville, 215-16
 Thionville, 31, 232, 248, 252
 Thunderbolt (plane), 229
 Thury Hercourt, 109
 Tiger tanks, 130, 132, 188-89,
 306
 Tille, 34, 177
 Timetable for plan of European
 invasion, 3
 Tirllemont, 237
 Tongres, 241
 Top Secret Control Section, 10
 Toul, 198, 248
 Touques River, 214-15
 Tours, 139, 144, 146, 176, 196,
 218
 Tours la Riche, 139, 151
 Transportation Div., IX AFSC, 22
 Trier, 264, 271, 273, 275, 281-82,
 285-86, 320
 Troop List, 8
 Trouville, 78
 Troyes, 159, 176, 190, 192, 195,
 198

U

U-7753, 244
 U-7858, 244
 U-7950, 244
 Ubach, 301
 Udenbreth, 293
 United Kingdom, 1, 16, 18, 21,
 23-24, 26-27, 29, 31, 33,
 50, 55
 Unit Serial, 8
 U. S. Army Forces in the United
 Kingdom, 1
 U. S. Naval Forces in Europe,
 2
 U.S.S.R., 152
 U. S. Strategical Air Force,
 56, 236
 Ussy, 120
 Utah Beach, 18, 25, 61, 70,
 75, 80, 82, 84
 Uxbridge, 12, 25-26, 51,
 55-56, 97, 116, 143-44, 162

V

Valenciennes, 39, 239
 Valentin, 218
 Valkenburg, 236
 Valmandois, 213
 Valognes, 19, 78, 86, 90, 95
 Vandenberg, Maj. Gen., Hoyt S.,
 102, 161
 Veho, 297
 Vensbles, 173
 Vendome, 196
 Vengeons, 168
 Venlo, 266, 284
 Venraij, 284
 Verdun, 159, 195, 197, 233,
 289
 Vernand, 290
 Vernon, 40, 42-43, 85, 172,
 189-92
 Versailles, 152, 233
 Verviers, 289
 Verzy, 179
 Vettweiss, 319
 Vicht, 306
 Vierville sur Mer, 18

John Doe
Post, ...

MEMORANDUM FOR THE COMMANDING GENERAL, ARMY AIR FORCES:
(Attention AAF Historical Office)

Subject: Critique of Army Air Forces Historical
Studies: No. 36, Ninth Air Force, April
to November 1944

MEMORANDUM FOR THE COMMANDING GENERAL, ARMY AIR FORCES:
(Attention AAF Historical Office)

Subject: Critique of Army Air Forces Historical
Studies: No. 36, Ninth Air Force, April
to November 1944

MEMORANDUM FOR THE COMMANDING GENERAL, ARMY AIR FORCES:
(Attention AAF Historical Office)

Subject: Critique of Army Air Forces Historical
Studies: No. 36, Ninth Air Force, April
to November 1944

MEMORANDUM FOR THE COMMANDING GENERAL, ARMY AIR FORCES:
(Attention AAF Historical Office)

Subject: Critique of Army Air Forces Historical
Studies: No. 38, Ninth Air Force, April
to November 1944